



**Technický a zkušební ústav
stavební Praha, s.p.**

Prosecká 811/76a
190 00 Prague
Czech Republic
tel.: +420 286 019 400
W: www.tzus.cz



Member of



www.eota.eu

European Technical Assessment

ETA 22/0631
of 28/11/2023

General part

Technical Assessment Body issuing the European Technical Assessment

Technický a zkušební ústav stavební Praha, s.p.

Trade name of the construction product	KB, KG, KK, KL, KM, KM (2.5 mm), KMP, KMR, KMRP, KSO, KP, KPL, KR, KS, KW, KWO, LBZ, LK, LZ, WB, WBD, WBZ, WL, LBS
Product family to which the construction product belongs	Product area: 13 Three-dimensional Nailing Plates
Manufacturer	DOMAX Sp. z o.o. Aleja Parku Krajobrazowego 109 84-207 Koleczkowo Łężyce Republic of Poland
Manufacturing plant	DOMAX Sp. z o.o. Aleja Parku Krajobrazowego 109 84-207 Koleczkowo Łężyce Republic of Poland
This European Technical Assessment contains	142 pages including 6 Annexes, which form an integral part of this European Technical Assessment
This European Technical Assessment is issued in accordance with Regulation (EU) No 305/2011, on the basis of	EAD 130186-00-0603 Three-dimensional nailing plates
This version replaces	ETA 22/0631, version 01 issued on 31/10/2022

Translations of this European technical assessment in other languages shall fully correspond to the original issued document and should be identified as such.

Communication of this European Technical Assessment, including transmission by electronic means, shall be in full (excepted the confidential Annex(es) referred to above). However, partial reproduction may be made, with the written consent of the issuing Technical Assessment Body - Technický a zkušební ústav stavební Praha, s.p. Any partial reproduction has to be identified as such.

1 Technical description of the product

The three-dimensional nailing plates are one-piece, non-welded (KB, KG, KK, KL, KM, KM (2.5 mm), KMP, KMR, KMRP, KSO, KP, KPL, KRD, KS, KW, KWO, LBZ, LK, LZ, WB, WBD, WBZ, WL, LBS) elements made of the cold-formed steel sheet grade DX51D according to EN 10346, structural steel S235 according to EN 10025-2 or cold-formed steel grade DC01 according to EN 10130 with corrosion protection Fe/Zn 12, zinc coating mass of 275 g/m² or Hot-dip galvanization (HDG), (see list below). The three-dimensional nailing plates correspond to the drawings and dimensions given in Annex 1.

Table 1 Technical description of the product

Designation of Domax connector	Material	Thickness	Kind of corrosion protection	Type connector	Intended use
WB 1	DX51D	2	Z275	Beam-hanger	Used to connect two piece of timber, end-grain to side-grain or timber – concrete or timber – steel
WB 2					
WB 3					
WB 4					
WB 5					
WB 6					
WB 7					
WB 8					
WB 9					
WB 10					
WB 11					
WB 12					
WB 13					
WB 14					
WB 15					
WB 16					
WB 17					
WB 18					
WB 19					
WB 20					
WB 21					
WB 22					
WB 23					
WB 24					
WB 25					
WB 26					
WB 27					
WB 28					
WB 29					
WB 30					
WB 31					

Designation of Domax connector	Material	Thickness	Kind of corrosion protection	Type connector	Intended use
WB 32					
WB 33					
WB 34					
WB 35					
WB 36					
WB 37					
WB 38					
WB 64					
WBZ 20	DX51D	2	Z275	Beam-hanger	
WBZ 21					
WBZ 22					
WBZ 23					
WBZ 24					
WBZ 25					
WBZ 26					
WBZ 27					
WBZ 28					
WBZ 29					
WBZ 30					
WBZ 31					
WBZ 32					
WBZ 33					
WBZ 34					
WBZ 35					
WBZ 36					
WBZ 37					
WBD 105L	DX51D	2	Z275	Beam-hanger	
WBD 105P					
WBD 130L					
WBD130P					
WBD 140L					
WBD 140P					
WBD 170L					
WBD 170P					
WBD 200L					
WBD 200P					
WL 5	DX51D	1	Z275	Beam-hanger	
WL 6					
WL 7					
WL 8					
WL 9					
LK 1	DX51D	2	Z275	Angle	Used to connect two piece of timber
LK 2					

Designation of Domax connector	Material	Thickness	Kind of corrosion protection	Type connector	Intended use
LK 3					
LK 4					
LK 5					
LK 6					
LK 7					
LK 8					
KG	DX51D	1.5	Z275	Angle	
KRD 1	DX51D	2	Z275	Angle	Used to connect two piece of timber or timber – concrete or timber – steel
KRD 2					
KRD 3					
KRD 4					
KMP 1	DX51D	1.5	Z275	Angle	Used to connect two piece of timber
KMP 2					
KMP 3					
KMP 4					
KMP 5					
KMP 6					
KMP 7					
KMP 8					
KMP 9	DX51D	2	Z275	Angle	Used to connect two piece of timber or timber – concrete or timber – steel
KMR 1					
KMR 2					
KMR 3					
KMR 4					
KMR 5					
KMR 6					
KMR 7					
KMR 8					
KMR 9	DX51D	2	Z275	Angle	
KMRP 1					
KMRP 2					
KMRP 3	DX51D	2.5	Z275	Angle	
LZ 0					
LZ 1					
LZ 2					
LZ 3	DC01	1.5	Fe/Zn 12	Angle	
KS 1					
KS 2					
KS 3	DX51D	1.5	Z275	Angle	Used to connect two piece of timber
KSO 1					
KSO 2					
KSO 3					
KWO 1	DX51D	1.5	Z275	Angle	

Designation of Domax connector	Material	Thickness	Kind of corrosion protection	Type connector	Intended use
KWO 2		2			
KWO 3					
KWO 4					
KB 1	S235	3	Fe/Zn 12	Angle	
KB 2		4			
KB 3		5			
KP 1	DX51D	2.5	Z275	Angle	Used to connect two piece of timber or timber – concrete or timber – steel
KP 2					
KP 3					
KP 4					
KP 5					
KP 6					
KP 10					
KP 11					
KP 12					
KP 13					
KP 14					
KP 15					
KP 21					
KPL 1					
KPL 2					
KPL 3					
KPL 4					
KPL 10					
KPL 12					
KL 1	DX51D	2.5	Z275	Angle	
KL 2					
KL 3					
KL 4					
KL 5		2			
KL 101					
KL 104					
KL 105					
KW 1	DC01	1.5			
KW 2		2			
KW 3					
KW 4					
KW 5	S235	4	Fe/Zn 12	Angle	
KW 6		5			
KW 7	DC01	1.5			
KW 25					
KW 30					
KW 40					

Designation of Domax connector	Material	Thickness	Kind of corrosion protection	Type connector	Intended use
KW 50		2			
KW 60					
KW 80					
KW 100					
KW 125					
KW 150					
KK 1	DX51D	2	Z275	Angle	Used to connect two piece of timber
KK 2					
KK 3					
KK 21	DX51D	2	Z275	Angle	Used to connect two piece of timber or timber – concrete or timber – steel
KK 22					
KK 23					
KM 0	DX51D	2	Z275	Angle	Used to connect two piece of timber
KM 1					
KM 2					
KM 3					
KM 4					
KM 5					
KM 6					
KM 7					
KM 8					
KM 9					
KM 10					
KM 11					
KM 12					
KM 13					
KM 14					
KM 15					
KM 19					
KM 20					
KM 21					
KM 1 (2.5 mm)	DX51D	2.5	Z275	Angle	
KM 2 (2.5 mm)					
KM 4 (2.5 mm)					
KM 5 (2.5 mm)					
KM 6 (2.5 mm)					
KM 7 (2.5 mm)					
KM 8 (2.5 mm)					
KM 9 (2.5 mm)					
KM 10 (2.5 mm)					
KM 11 (2.5 mm)					
KM 12 (2.5 mm)					

Designation of Domax connector	Material	Thickness	Kind of corrosion protection	Type connector	Intended use
KM 13 (2.5 mm)					
KM 14 (2.5 mm)					
KM 15 (2.5 mm)					
KM 16 (2.5 mm)					
KM 17 (2.5 mm)					
KM 18 (2.5 mm)					
KM 19 (2.5 mm)					
KM 20 (2.5 mm)					
KM 22 (2.5 mm)					
LBS 90	DX51D	1.5	Z275	Angle	Used to connect two piece of timber or timber – concrete or timber – steel
LBS 105		2			
LBZ 95	S235	4	Fe/Zn 12 or Hot-dip galvanization (HDG)	Angle	
LBZ 135					
LBZ 285					

Yield strength for used steel DX51D is 307 MPa, tensile strength is 371 MPa (thickness 1.0 mm).
Yield strength for used steel DX51D is 294 MPa, tensile strength is 362 MPa (thickness 1.5 mm).
Yield strength for used steel DX51D is 251 MPa, tensile strength is 356 MPa (thickness 2.0 mm).
Yield strength for used steel DX51D is 288 MPa, tensile strength is 368 MPa (thickness 2.5 mm).

Yield strength for used steel DC01 is 199 MPa, tensile strength is 317 MPa (thickness 1.5 mm).
Yield strength for used steel DC01 is 200 MPa, tensile strength is 332 MPa (thickness 2.0 mm).

Yield strength for used steel S235JR is 312 MPa, tensile strength is 401 MPa (thickness 3.0 mm).
Yield strength for used steel S235JR is 307 MPa, tensile strength is 387 MPa (thickness 4.0 mm).
Yield strength for used steel S235JR is 304 MPa, tensile strength is 410 MPa (thickness 5.0 mm).

1.1 Identification

The identification parameters and reference to product specifications for identifying the materials and components which constitute the three-dimensional nailing plates are given in Annexes.

2 Specification of the intended use(s) in accordance with the applicable European Assessment Document (hereinafter EAD)

The three-dimensional nailing plates are intended to be used as connections in loadbearing timber structures (to connect two pieces of timber or timber to concrete or steel). For connecting the mutually perpendicular, load-bearing, solid timber elements, end-grain to side-grain, in joints for which requirements for mechanical resistance and stability in the sense of the Basic Works Requirement 1 of Regulation (EU) No 305/2011 shall be fulfilled.

For connections made with the three-dimensional nailing plates shall be used the elements described in Annex 1.

The materials' specification or minimum corrosion protection for different service classes are stated in accordance with EN 1995-1-1 (Eurocode 5). Alternative materials may be used provided that they have sufficient corrosion protection for the proposed intended use shown

by assessment or testing taking into account the connection points between the nailing plate and the fastener and that they do not change performance of the nailing plate.

The provisions made in this European Technical Assessment are based on an assumed working life of the product of 50 years. The indications given on the working life cannot be interpreted as a guarantee given by the producer, but are to be regarded only as a means for choosing the right products in relation to the expected economically reasonable working life of the works.

The assessment of the fitness of the three-dimensional nailing plates for the intended use has been made in compliance with the European Assessment Document (EAD) 130186-00-0603 Three-dimensional nailing plates.

2.1 Installation of three-dimensional nailing plates

The installation instructions including special installation techniques and provisions for the qualification of the personnel are given in the manufacturer's technical documentation.

3 Performance of the product and references to the methods used for its assessment

The assessment of the fitness for use of the above-mentioned three-dimensional nailing plates according to the Basic Work Requirements (BWR) were carried out in compliance with EAD 130186-00-0603.

The European Technical Assessment is issued for the three-dimensional nailing plates on the basis of agreed data and information, deposited at Technický a zkušební ústav stavební Praha, s.p., which identifies three-dimensional nailing plates that has been assessed and judged. Changes to the plates or production process which could result in this deposited data and information being incorrect should be notified to Technický a zkušební ústav stavební Praha, s.p. before the changes are introduced. Technický a zkušební ústav stavební Praha, s.p. will decide whether or not such changes affect the ETA and consequently the validity of the CE marking on the basis of the ETA and if so whether further assessment or alternations to the ETA shall be necessary.

Table 2 Essential characteristics of the product

	Essential characteristic	Performance
3.1 BWR 1: Mechanical resistance and stability		
3.1.1	Joint strength	See Annex 3
3.1.2	Joint stiffness	NPA
3.1.3	Joint ductility	NPA
3.1.4	Resistance to seismic actions	NPA
3.1.5	Resistance to corrosion and deterioration	NPA
3.2 BWR 2: Safety in case of fire		
3.2.1	Reaction to fire	The steel elements are classified as class A1 of reaction to fire (non-combustible products) in accordance with EN 13501-1 and to European Commission Decision 96/603/EC amended by European Commission Decision 2000/605/EC.
3.2.2	Resistance to fire	NPA

3.1 Mechanical resistance and stability (BWR 1)

3.1.1 Joint strength

The load-carrying capacities of joints loaded according to static diagrams (shown in Annex 2), determined by testing or calculations carried out according to EAD 130186-00-0603, clause 2.2.1 and EN 1995-1-1 are given in Annex 3. The load-carrying capacities of joints for other load directions shall be calculated on the basis of EN 1995-1-1 (Eurocode 5) or according to national regulations. The design values shall be determined according to EN 1995-1-1 (Eurocode 5).

Following the requirements of EAD, the applicant provided to the TAB calculation and testing results, configuration of the connections and static schemes (direction of force actions).

3.1.2 Joint stiffness

No performance assessed.

3.1.3 Joint ductility

No performance assessed.

3.2 Safety in case of fire (BWR 2)

3.2.1 Reaction to fire

The steel elements are classified as class A1 of reaction to fire (non-combustible products) in accordance with EN 13501-1 and to European Commission Decision 96/603/EC amended by European Commission Decision 2000/605/EC.

3.2.2 Resistance to fire

Performance in relation to fire resistance would be determined for the complete structural element with any associated finishes, therefore there is no performance assessed option used to this Basic Work Requirement.

4 Assessment and verification of constancy of performance (hereinafter AVCP) system applied, with reference to its legal base

According to the Decision 1997/638/EC¹, of the European Commission the system(s) of assessment and verification of constancy of performance (see Annex V to Regulation (EU) No 305/2011 and Commission delegated Regulation (EU) No 568/2014) given in the following table applies:

Product(s)	Intended use(s)	Level(s) or class(es)	Attestation of conformity system(s)
Shear plates, toothed-plate connectors, punched nail plates, nailing plates	For structural timber products		2+

¹ Official Journal of the European Communities L 268/37 of 1.10.1997

5 Technical details necessary for the implementation of the AVCP system, as provided for in the applicable EAD

Technical details necessary for the implementation of the AVCP system are laid down in the control plan deposited at Technický a zkušební ústav stavební Praha, s.p.

Issued in Prague on 28/11/2023

By
Ing. Jiří Studnička, Ph.D.
Head of the TAB

Annexes:

- Annex 1 Product details and definitions
- Annex 2 Loading according to static diagrams
- Annex 3 The load-carrying capacities of connectors
- Annex 4 Nailing patterns
- Annex 5 Specification of connection elements
- Annex 6 Reference documents

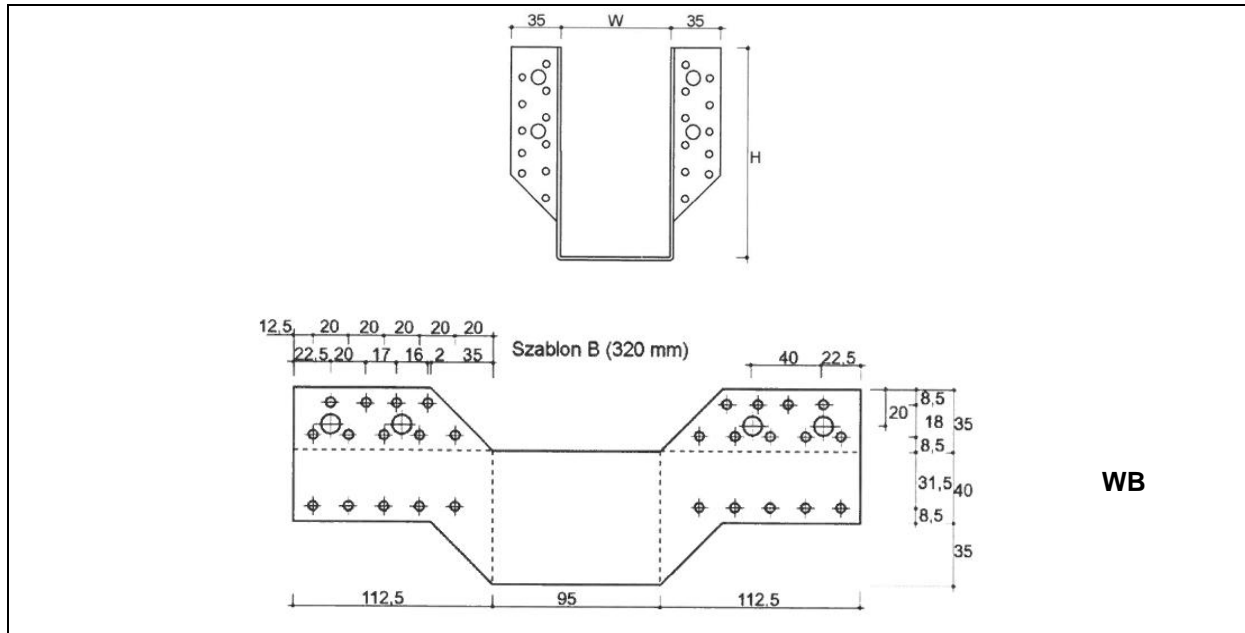

Figure 1 Type WB

Table 3 WB three-dimensional nailing plate symbols and dimensions

Symbol	Dimensions [mm]		Template	Quantity of openings	
	W	H		Ø 5	Ø 11
WB1	25	118	A	22	2
WB2	38	111	A	22	2
WB3	38	141	B	28	4
WB4	38	171	C	34	4
WB5	41	110	A	22	2
WB6	41	140	B	28	4
WB7	41	170	C	34	4
WB8	45	108	A	22	2
WB9	45	138	B	28	4
WB10	51	105	A	22	2
WB11	51	135	B	28	4
WB12	51	165	C	34	4
WB13	51	195	D	40	6
WB14	60	100	A	22	2
WB15	60	130	B	28	4
WB16	60	160	C	34	4
WB17	60	190	D	40	6
WB18	60	220	E	46	6
WB19	64	98	A	22	2

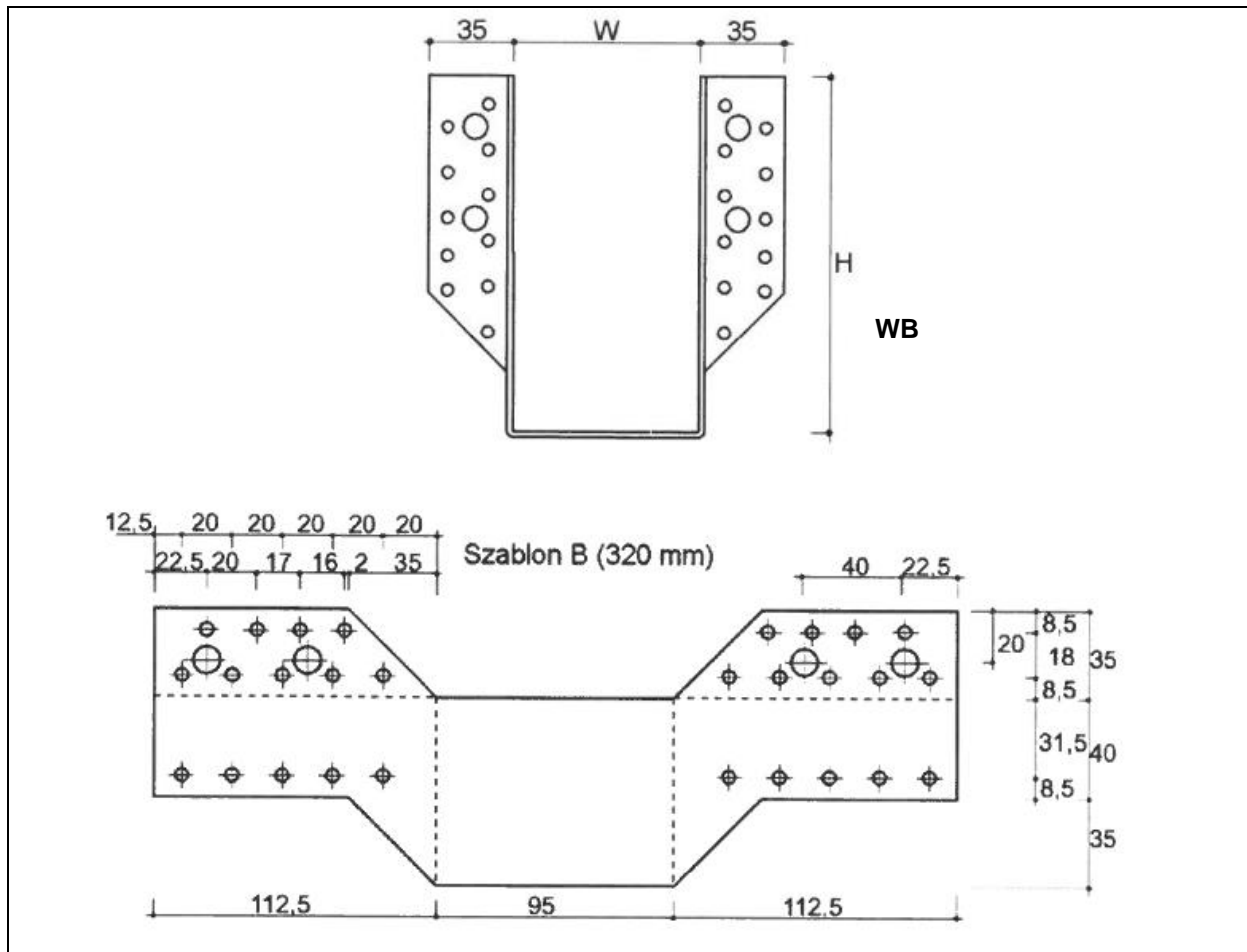

Figure 2 Type WB

Table 4 WB three-dimensional nailing plate symbols and dimensions

Symbol	Dimensions [mm]		Template	Quantity of openings	
	W	H		Ø 5	Ø 11
WB20	64	128	B	28	4
WB21	70	125	B	28	4
WB22	70	155	C	34	4
WB23	76	122	B	28	4
WB24	76	152	C	34	4
WB25	76	182	D	40	6
WB26	80	120	B	28	4
WB27	80	150	C	34	4
WB28	80	180	D	40	6
WB29	80	210	E	46	6
WB30	100	140	C	34	4
WB31	100	170	D	40	6
WB32	100	200	E	46	6
WB33	115	163	D	40	6
WB34	115	193	E	46	6
WB35	120	160	D	40	6
WB36	120	190	E	46	6
WB37	140	180	E	46	6
WB38	160	170	E	46	6

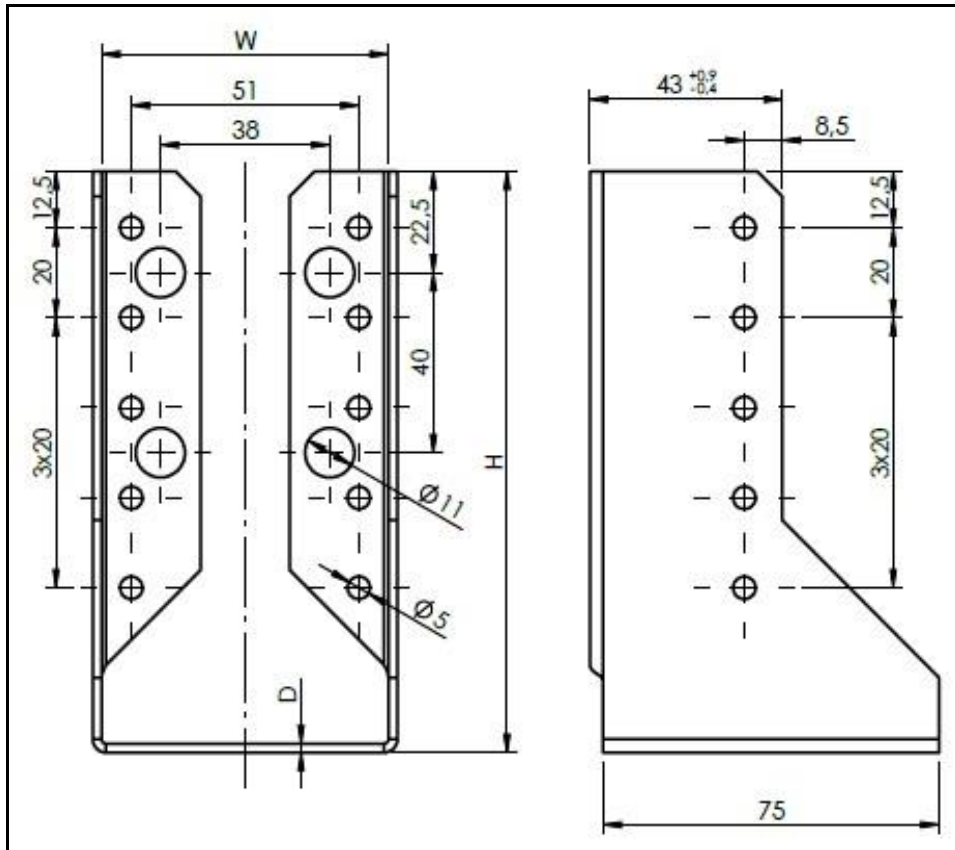

Figure 3 Type WBZ

Table 5 WBZ three-dimensional nailing plate symbols and dimensions

Symbol	Dimensions [mm]			Quantity of openings	
	W	H	D	Ø5	Ø11
WBZ 20	64	129	2	20	4

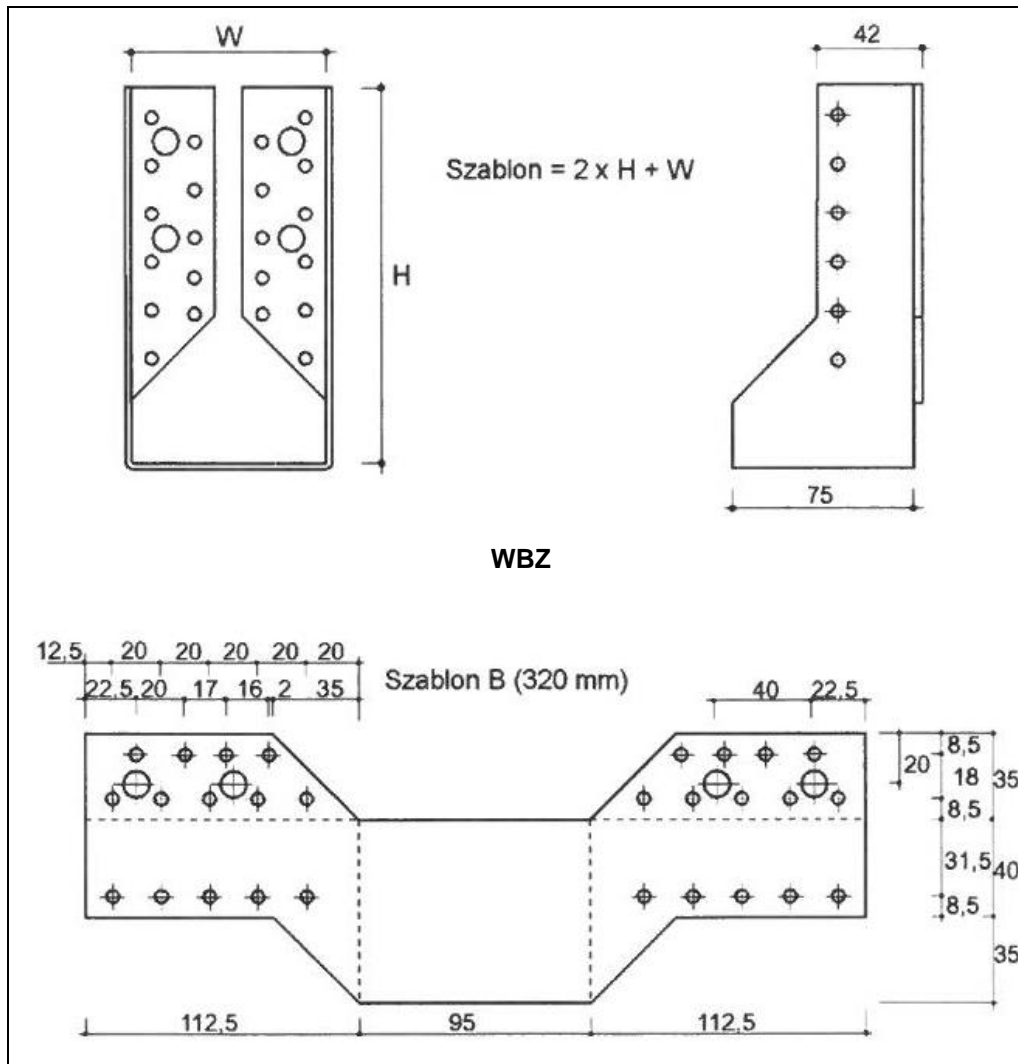

Figure 4 Type WBZ

Table 6 WBZ three-dimensional nailing plate symbols and dimensions

Symbol	Dimensions [mm]		Template	Quantity of openings	
	W	H		Ø 5	Ø 11
WBZ21	70	125	B	28	4
WBZ22	70	155	C	34	4
WBZ23	76	122	B	28	4
WBZ24	76	152	C	34	4
WBZ25	76	182	D	40	6
WBZ26	80	120	B	28	4
WBZ27	80	150	C	34	4
WBZ28	80	180	D	40	6
WBZ29	80	210	E	46	6
WBZ30	100	140	C	34	4
WBZ31	100	170	D	40	6
WBZ32	100	200	E	46	6
WBZ33	115	163	D	40	6
WBZ34	115	193	E	46	6
WBZ35	120	160	D	40	6
WBZ36	120	190	E	46	6
WBZ37	140	180	E	46	6

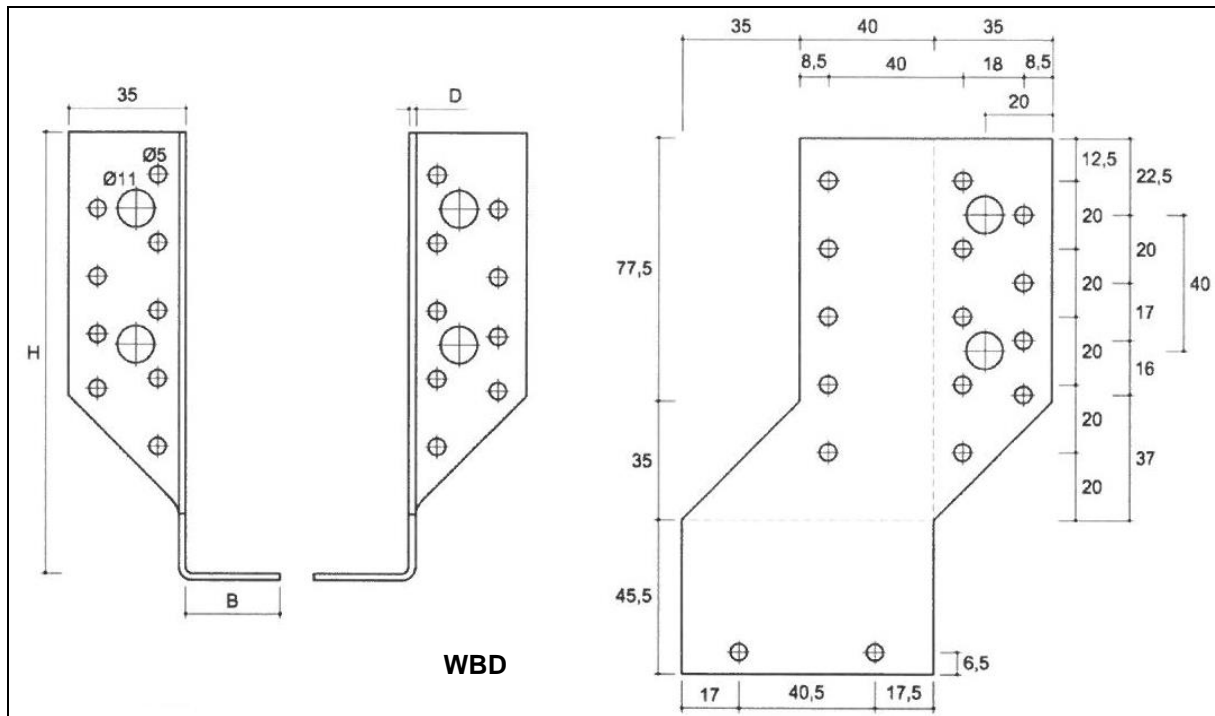

Figure 5 Type WBD

Table 7 WBD three-dimensional nailing plate symbols and dimensions

Symbol	Dimensions [mm]			Type	Quantity of openings	
	H	B	D		Ø 5	Ø 11
WBD105L WBD105P	105	25	2	A1	13	1
WBD130L WBD130P	130	28	2	81	16	2
WBD140L WBD140P	140	50	2	C1	19	2
WBD170L WBD170P	170	50	2	D1	22	3
WBD200L WBD200P	200	50	2	E1	25	3

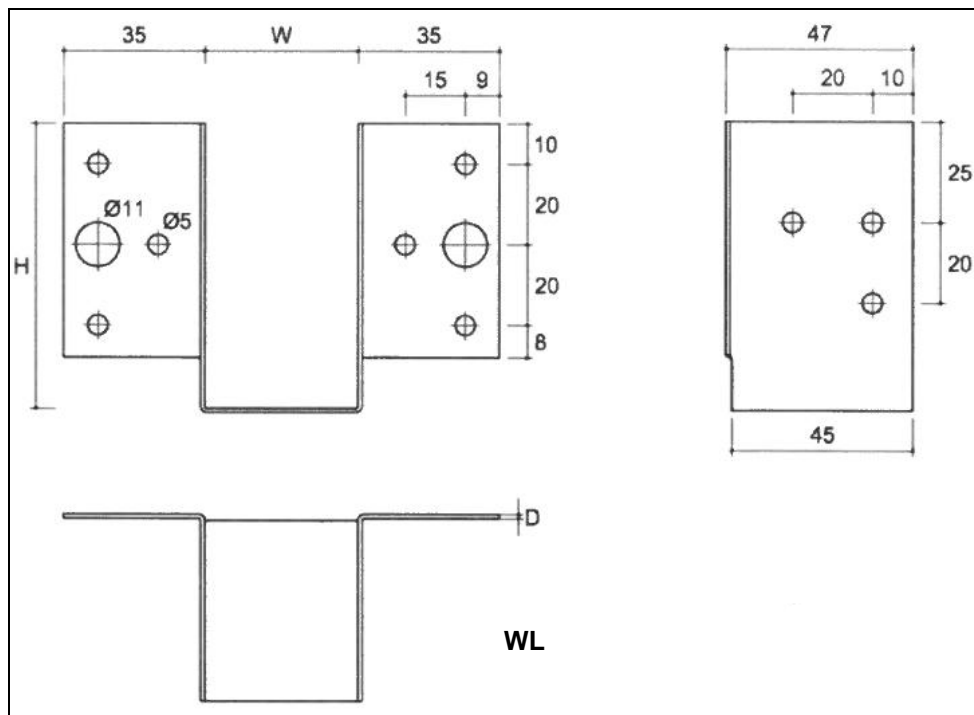

Figure 6 Type WL

Table 8 WL three-dimensional nailing plate symbols and dimensions

Symbol	Dimensions [mm]			Quantity of openings	
	W	H	D	Ø 5	Ø 11
WL 5	25	77	1	12	2
WL 6	38	71	1	12	2
WL 7	41	70	1	12	2
WL 8	51	65	1	12	2
WL 9	60	60	1	12	2

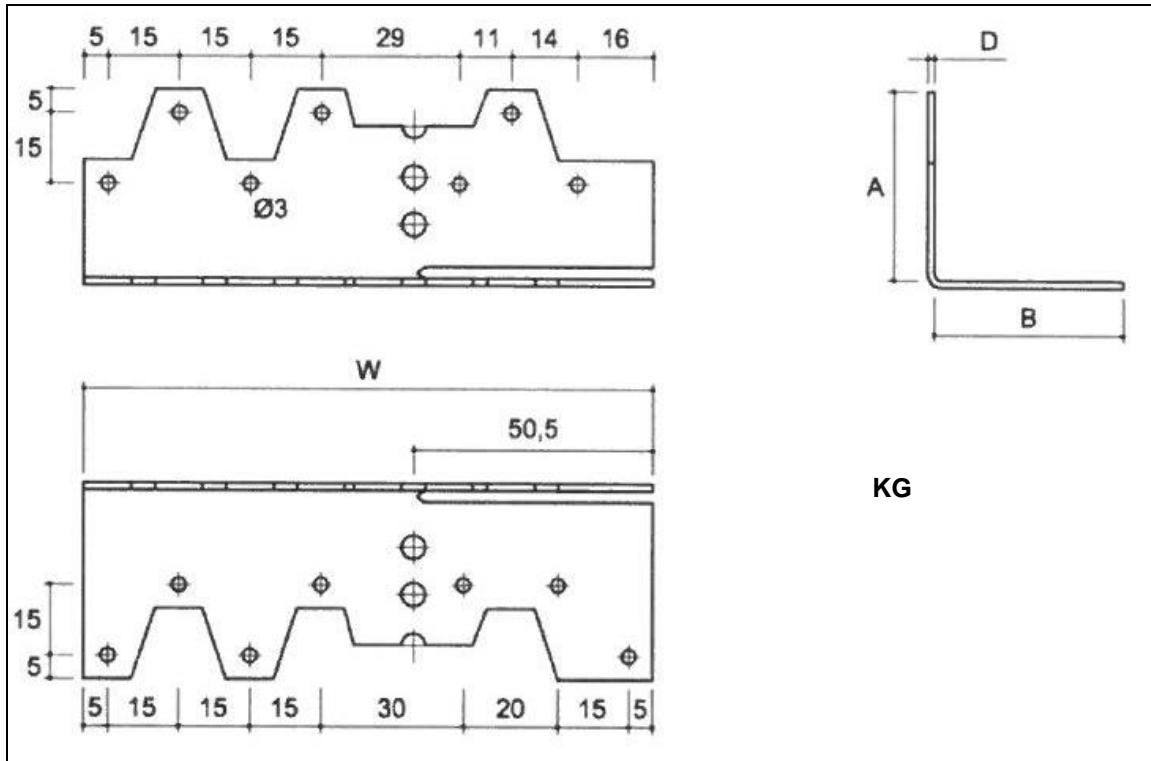

Figure 7 Type KG

Table 9 KG three-dimensional nailing plate symbols and dimensions

Symbol	Dimensions [mm]				Quantity of openings
	W	A	B	D	$\varnothing 3$
KG	120	40	40	1.5	14

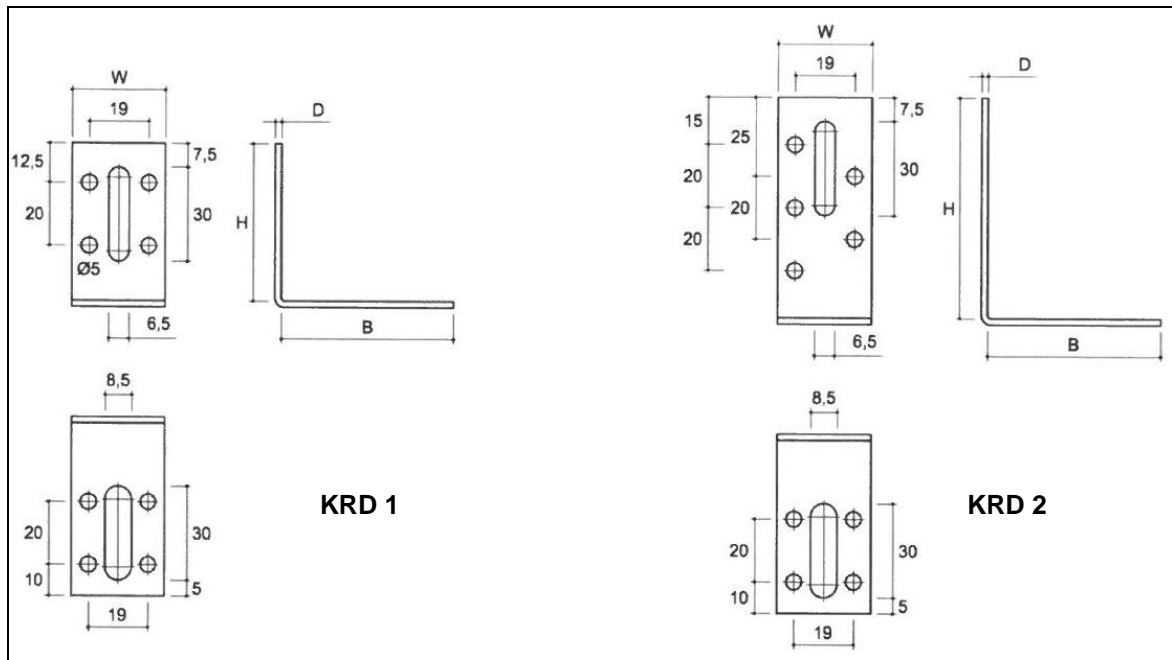

Figure 8 Type KRD

Table 10 KRD three-dimensional nailing plate symbols and dimensions

Symbol	Dimensions [mm]				Quantity of openings
	W	H	B	D	Ø 5
KRD 1	30	50	55	2	8
KRD 2	30	70	55	2	9

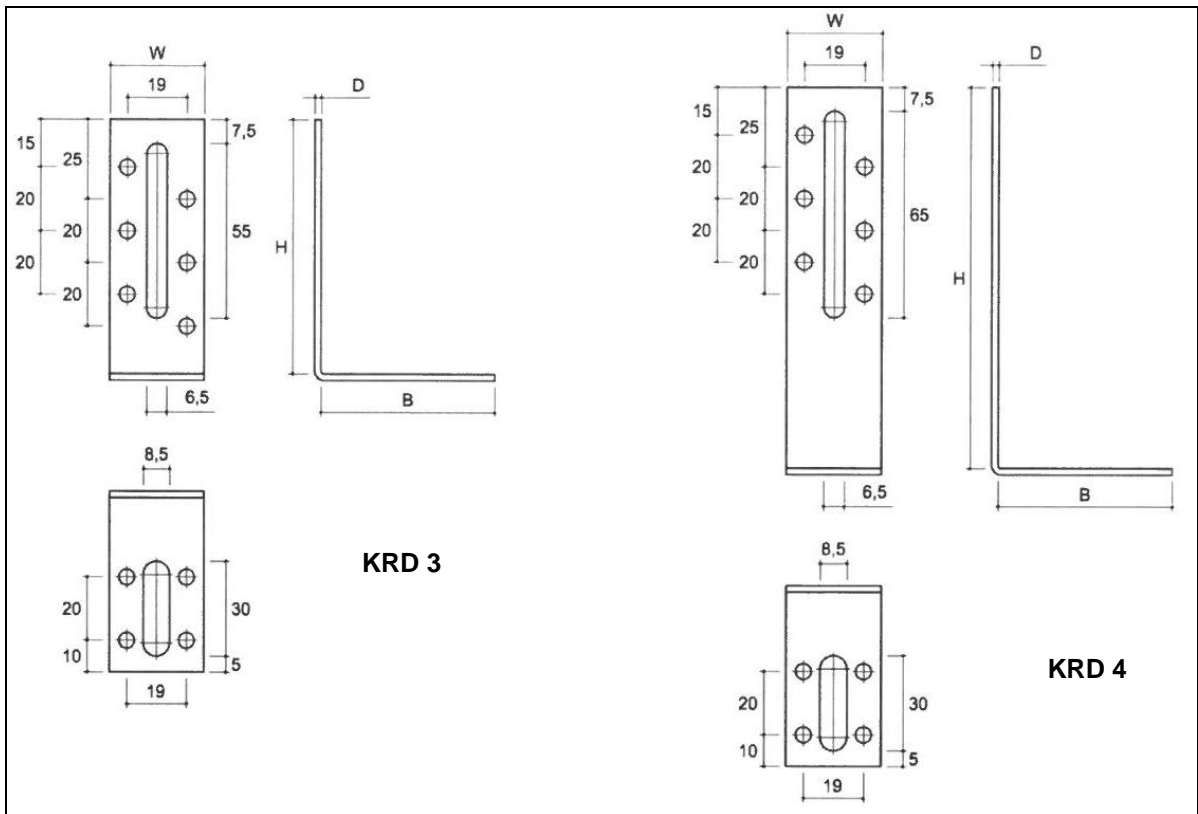

Figure 9 Type KRD

Table 11 KRD three-dimensional nailing plate symbols and dimensions

Symbol	Dimensions [mm]				Quantity of openings
	W	H	B	D	Ø 5
KRD 3	30	80	55	2	10
KRD 4	30	120	55	2	10

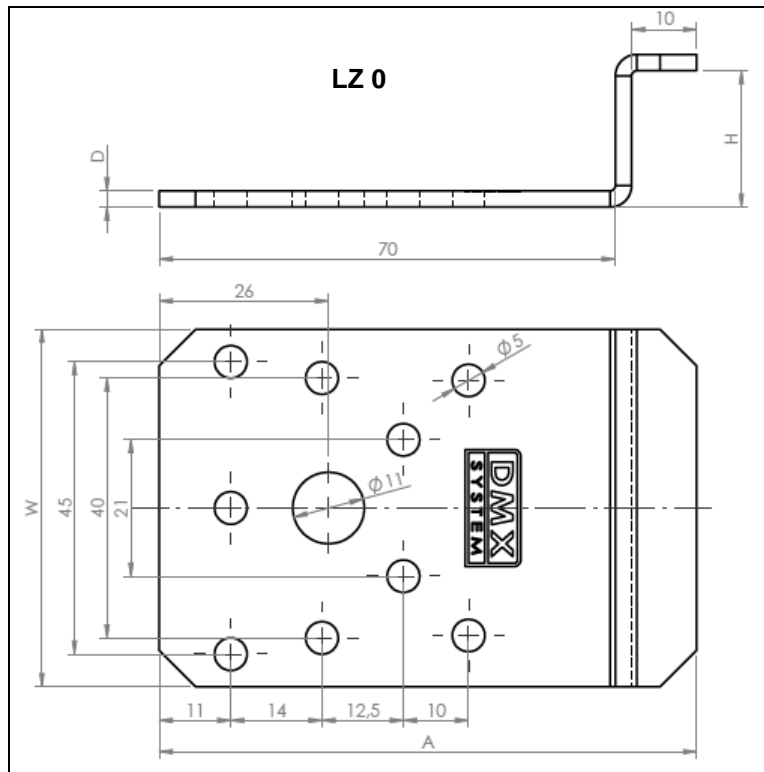

Figure 10 Type LZ

Table 12 LZ three-dimensional nailing plate symbols and dimensions

Symbol	Dimensions [mm]				Quantity of openings	
	W	H	A	D	Ø 5	Ø 11
LZ 0	55	21	82.5	2.5	9	1

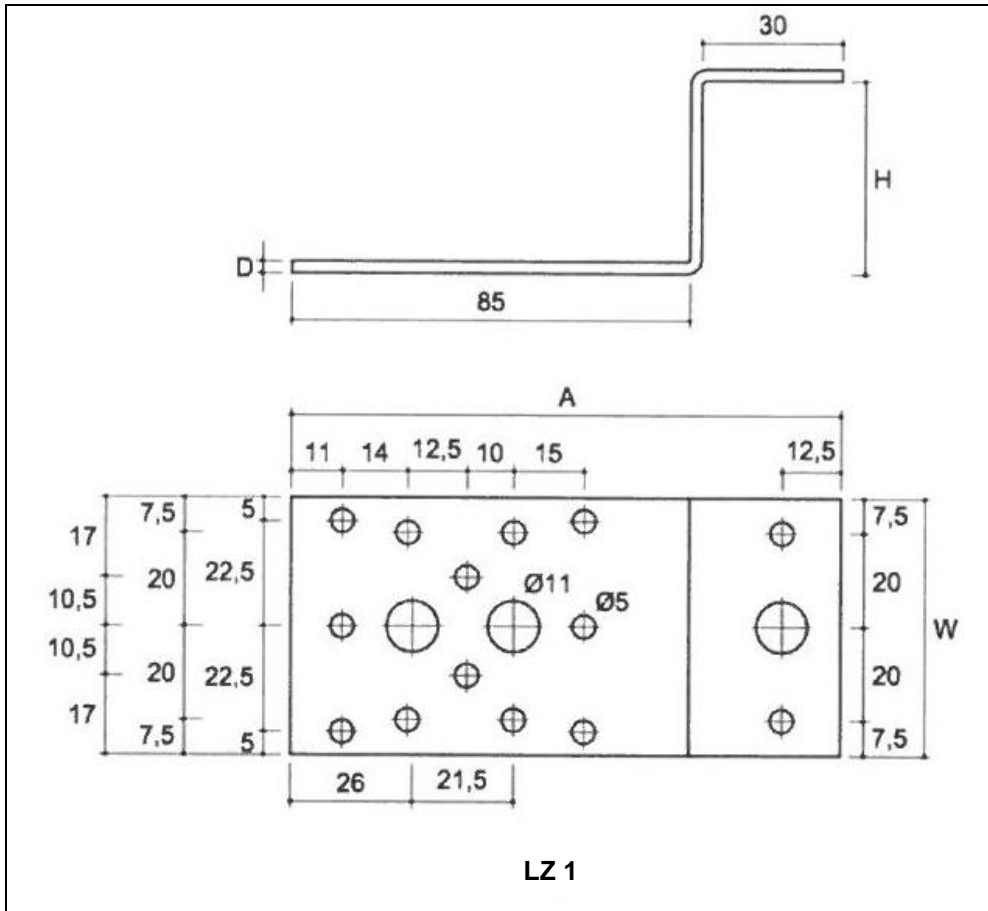

Figure 11 Type LZ

Table 13 LZ three-dimensional nailing plate symbols and dimensions

Symbol	Dimensions [mm]				Quantity of openings	
	W	H	A	D	Ø 5	Ø 11
LZ 1	55	41	117.5	2.5	14	3
LZ 2	55	51	117.5	2.5	14	3
LZ 3	55	61	117.5	2.5	14	3

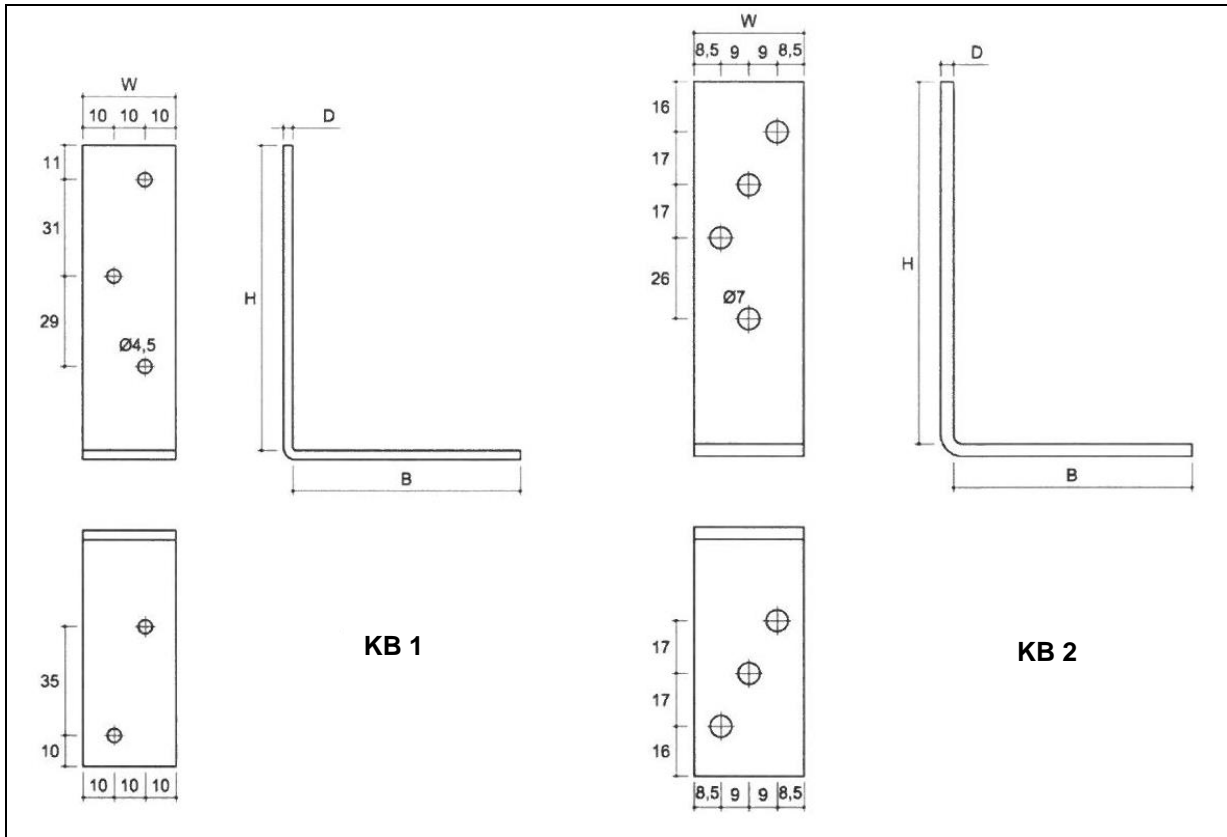

Figure 12 Type KB

Table 14 KB three-dimensional nailing plate symbols and dimensions

Symbol	Dimensions [mm]				Quantity of openings	
	W	H	B	D	Ø 4.5	Ø 7
KB 1	30	98	73	3	5	-
KB 2	35	116	76	4	-	7

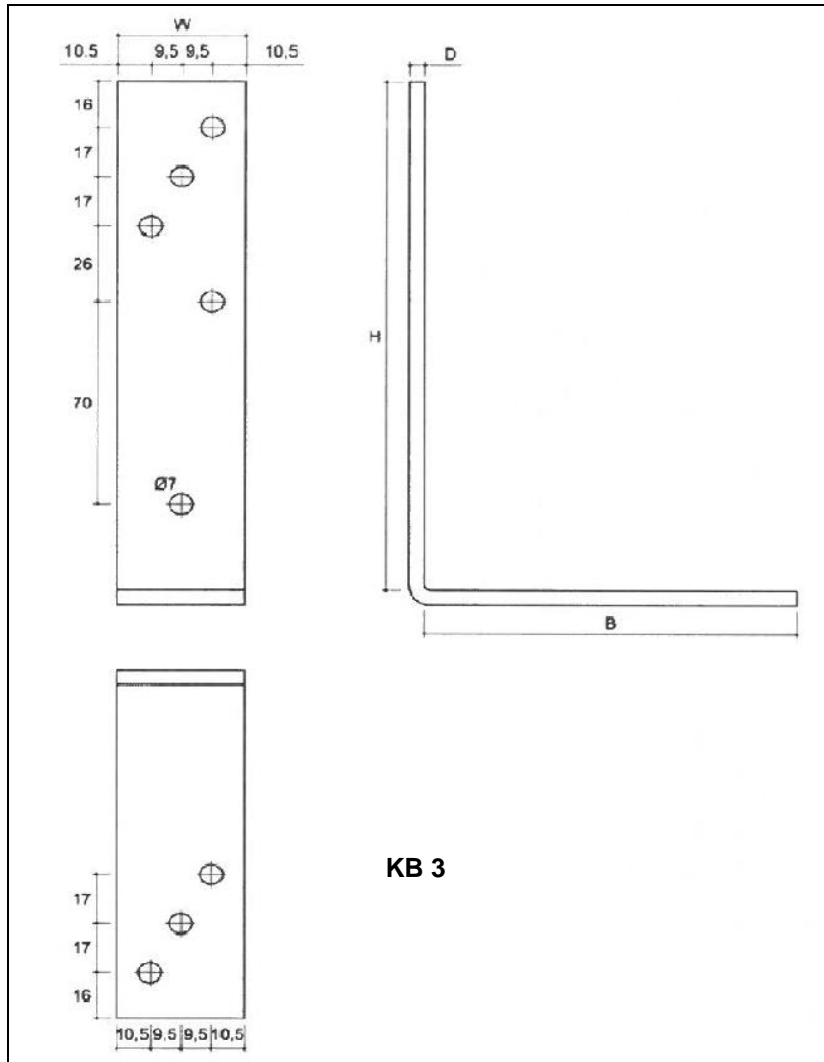

Figure 13 Type KB

Table 15 KB three-dimensional nailing plate symbols and dimensions

Symbol	Dimensions [mm]				Quantity of openings	
	W	H	B	D	Ø 4.5	Ø 7
KB 3	40	176	116	5	-	8

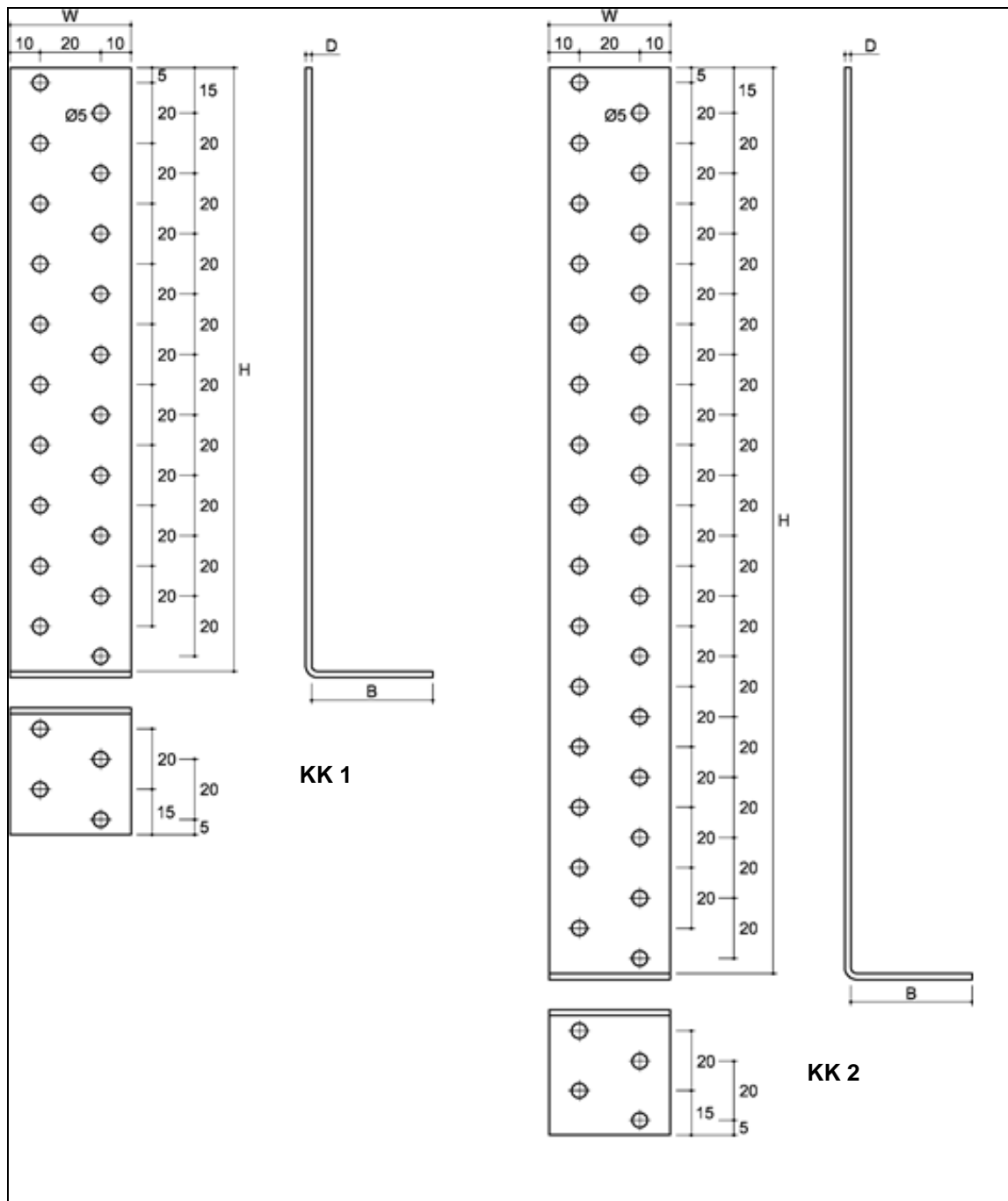

Figure 14 Type KK

Table 16 KK three-dimensional nailing plate symbols and dimensions

Symbol	Dimensions [mm]				Quantity of openings
	W	H	B	D	
KK 1	40	200	40	2	24
KK 2	40	300	40	2	34

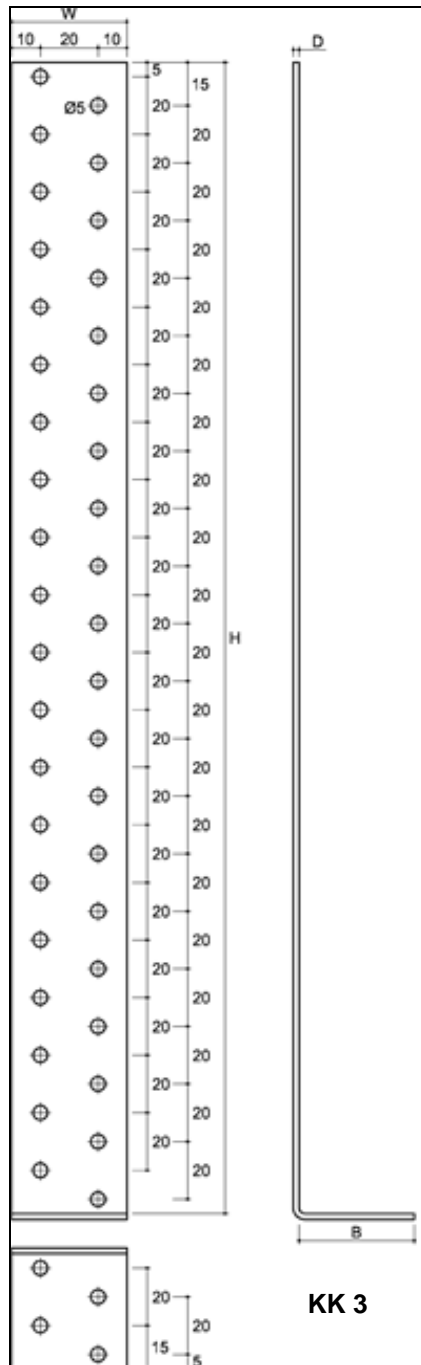

Figure 15 Type KK

Table 17 KK three-dimensional nailing plate symbols and dimensions

Symbol	Dimensions [mm]				Quantity of openings
	W	H	B	D	Ø 5
KK 3	40	400	40	2	44

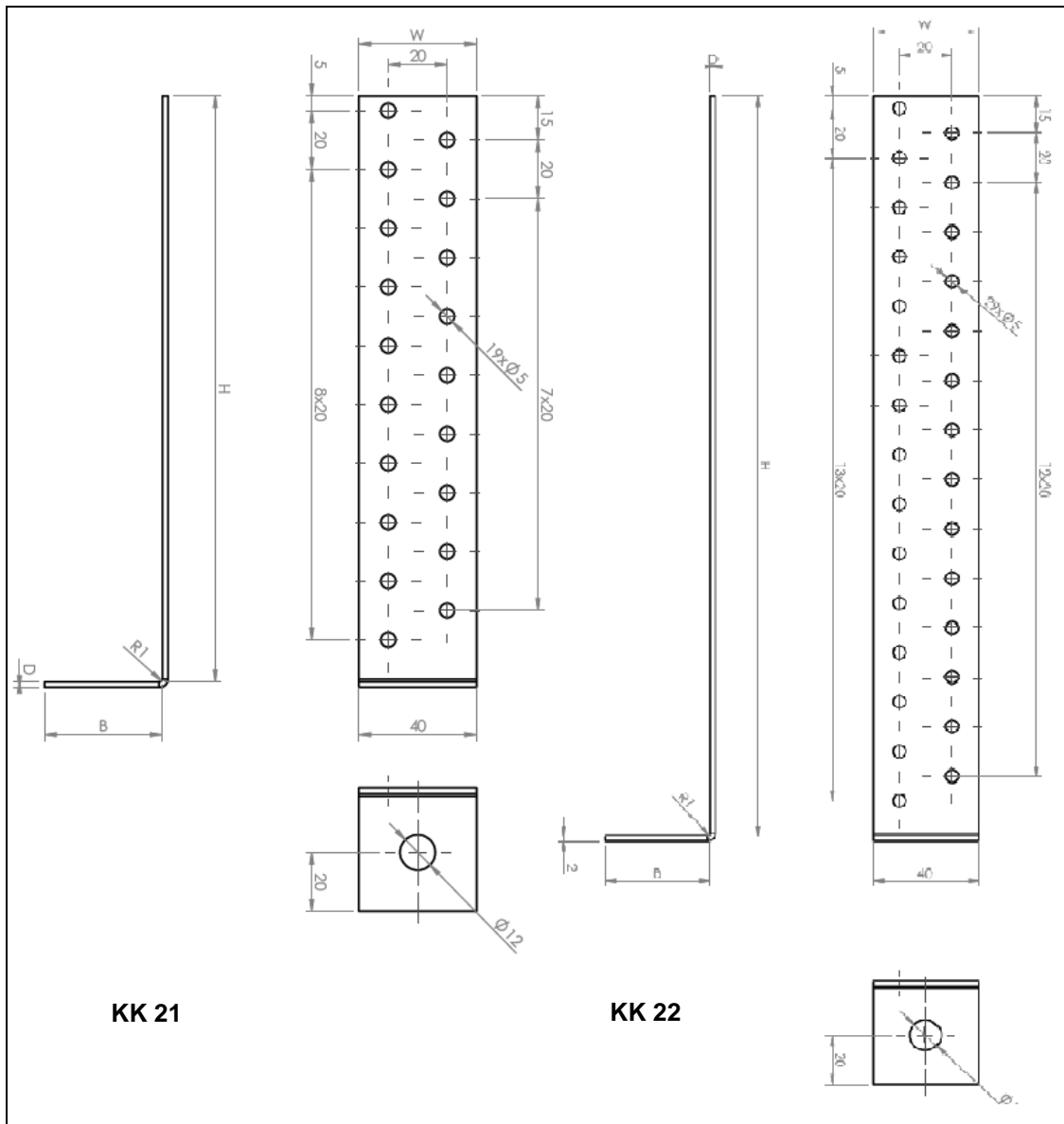

Figure 16 Type KK

Table 18 KK three-dimensional nailing plate symbols and dimensions

Symbol	Dimensions [mm]				Quantity of openings	
	W	H	B	D	Ø 5	Ø 12
KK 21	40	200	40	2	19	1
KK 22	40	300	40	2	29	1

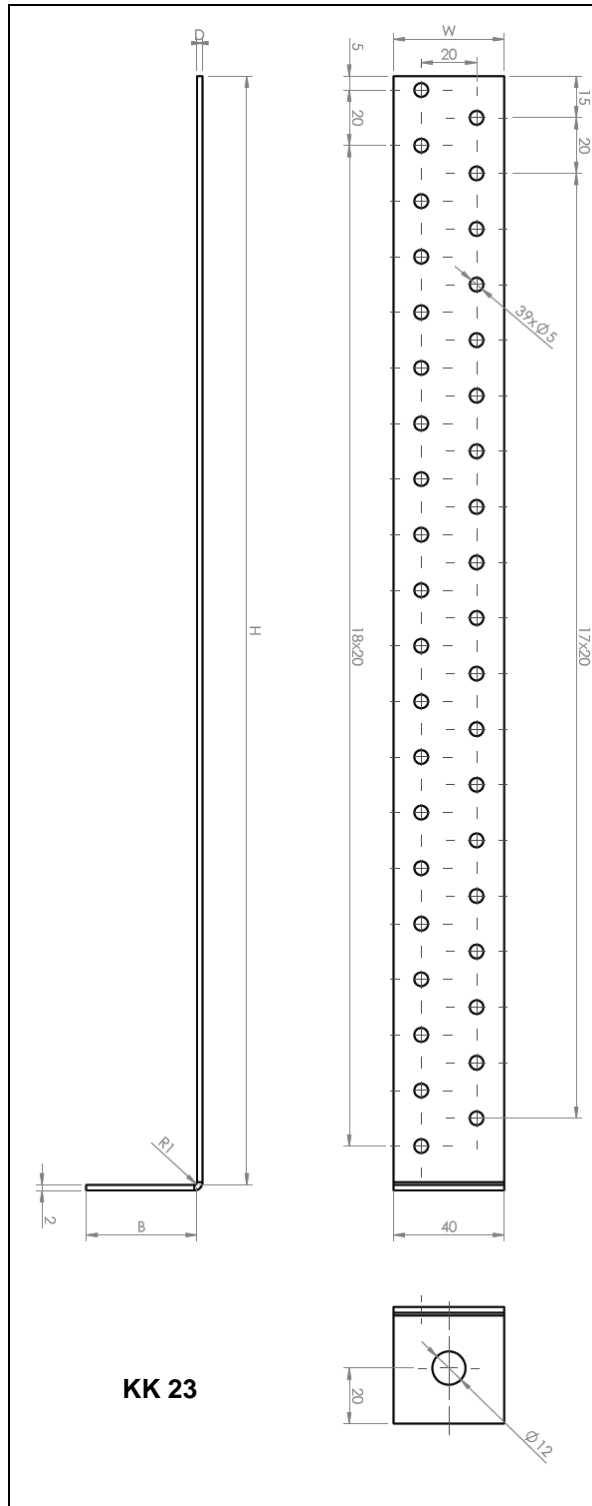

Figure 17 Type KK

Table 19 KK three-dimensional nailing plate symbols and dimensions

Symbol	Dimensions [mm]				Quantity of openings	
	W	H	B	D	Ø 5	Ø 12
KK 23	40	400	40	2	39	1

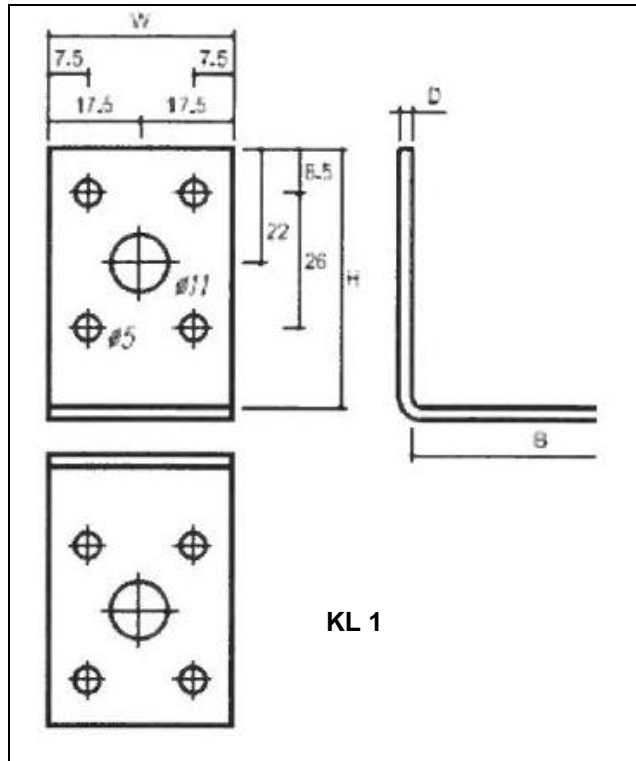

Figure 18 Type KL

Table 20 KL three-dimensional nailing plate symbols and dimensions

Symbol	Dimensions [mm]				Quantity of openings			
	W	H	B	D	Ø 5	Ø 7	Ø 11	Ø14
KL 1	35	50	50	2.5	8	-	2	-

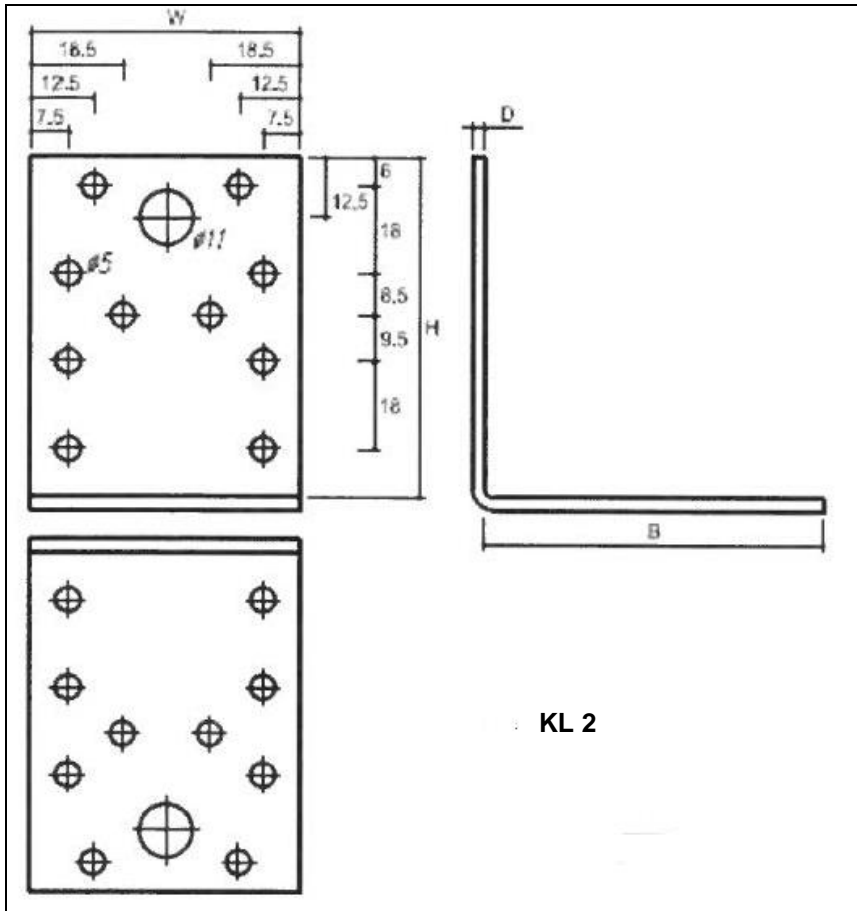
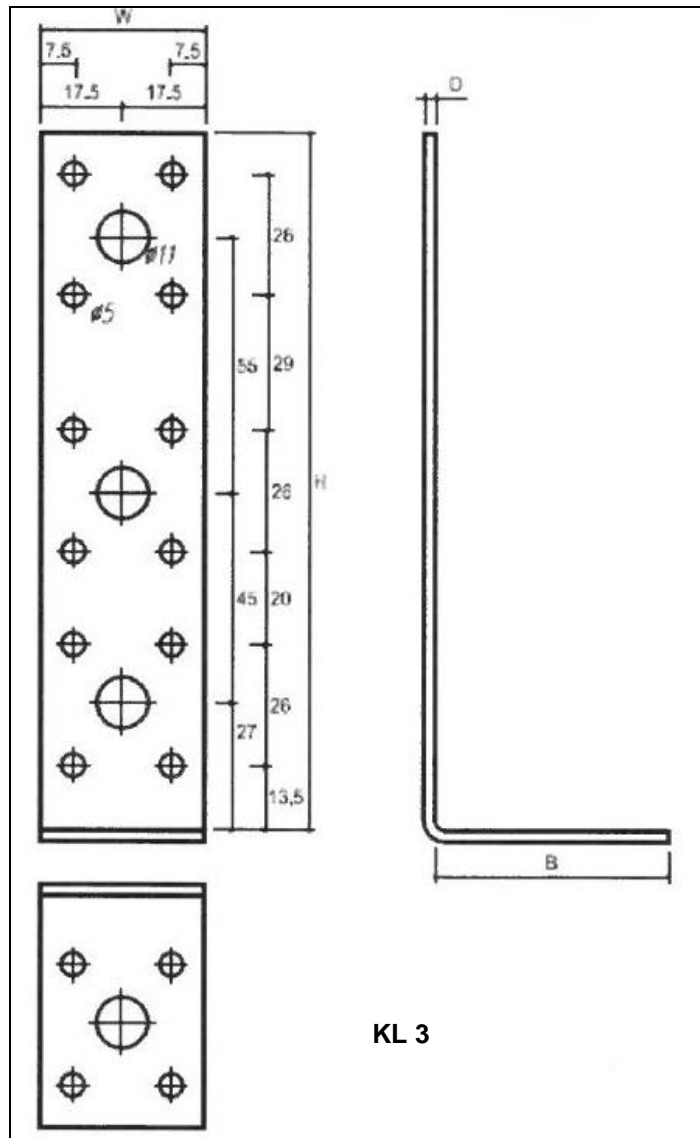

Figure 19 Type KL

Table 21 KL three-dimensional nailing plate symbols and dimensions

Symbol	Dimensions [mm]				Quantity of openings			
	W	H	B	D	Ø 5	Ø 7	Ø 11	Ø 14
KL 2	55	70	70	2.5	20	-	2	-



KL 3

Figure 20 Type KL

Table 22 KL three-dimensional nailing plate symbols and dimensions

Symbol	Dimensions [mm]				Quantity of openings			
	W	H	B	D	Ø 5	Ø 7	Ø 11	Ø14
KL 3	35	150	50	2.5	16	-	4	-

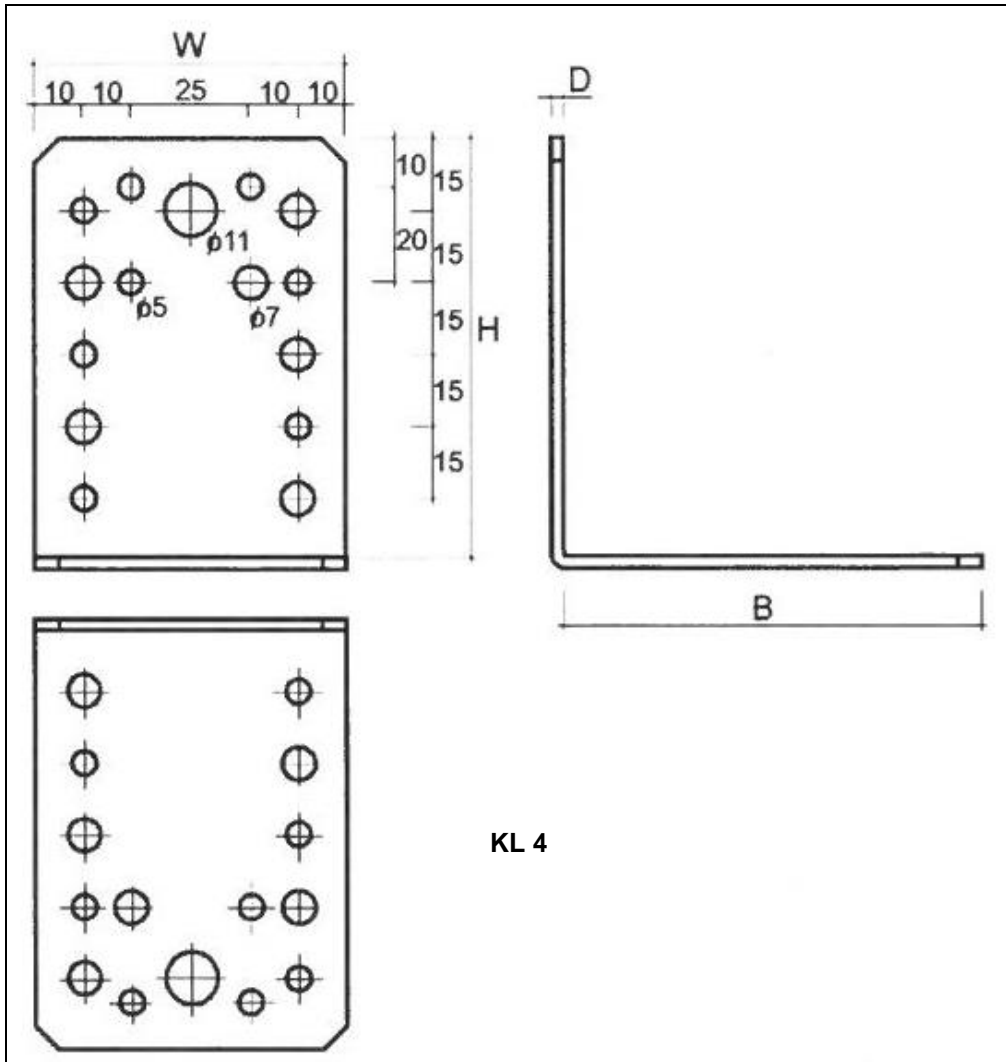

Figure 21 Type KL

Table 23 KL three-dimensional nailing plate symbols and dimensions

Symbol	Dimensions [mm]				Quantity of openings			
	W	H	B	D	Ø 5	Ø 7	Ø 11	Ø 14
KL 4	65	90	90	2.5	16	12	2	-

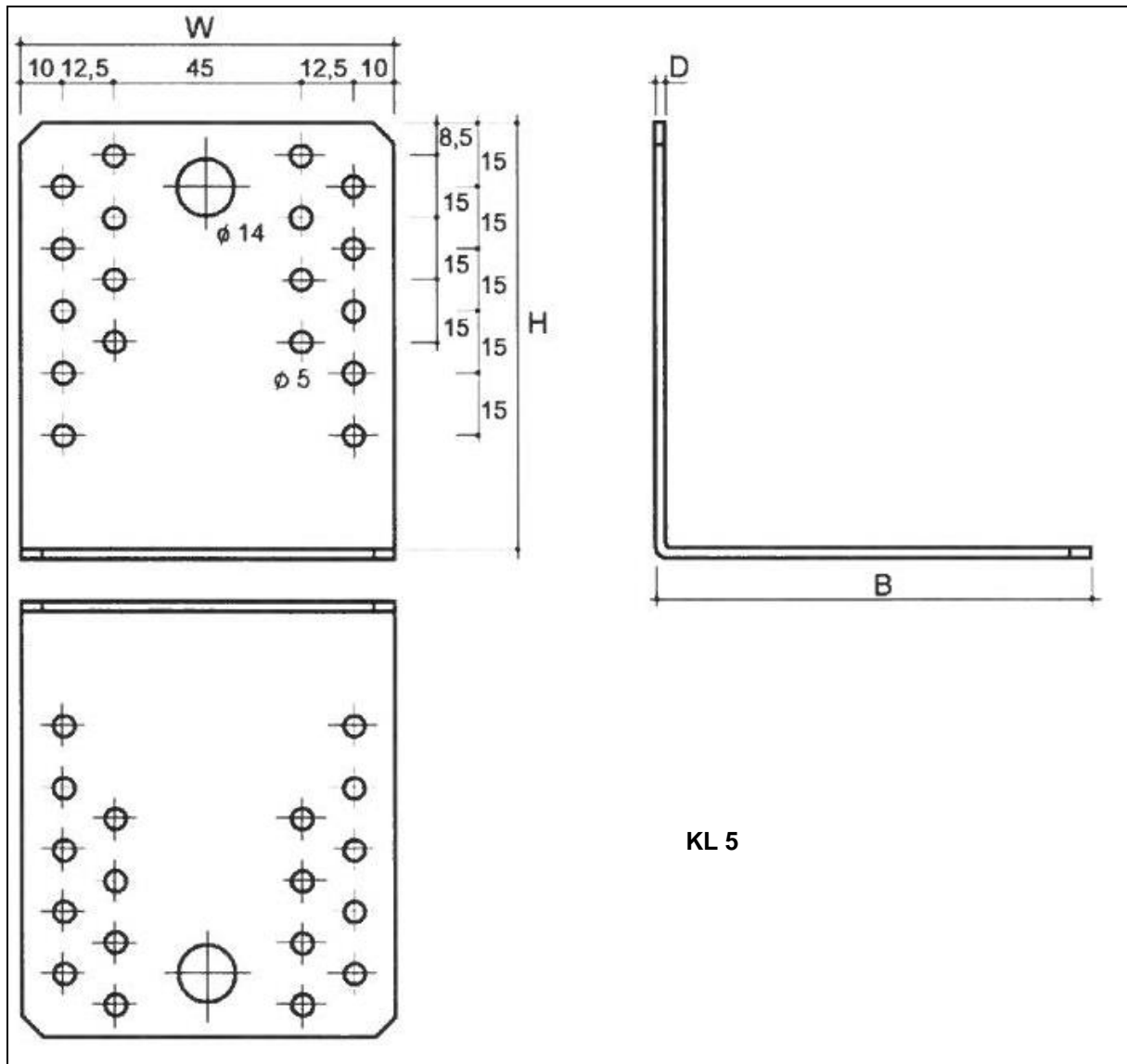

Figure 22 Type KL

Table 24 KL three-dimensional nailing plate symbols and dimensions

Symbol	Dimensions [mm]				Quantity of openings			
	W	H	B	D	Ø 5	Ø 7	Ø 11	Ø 14
KL 5	90	105	105	2.5	36	-	-	2

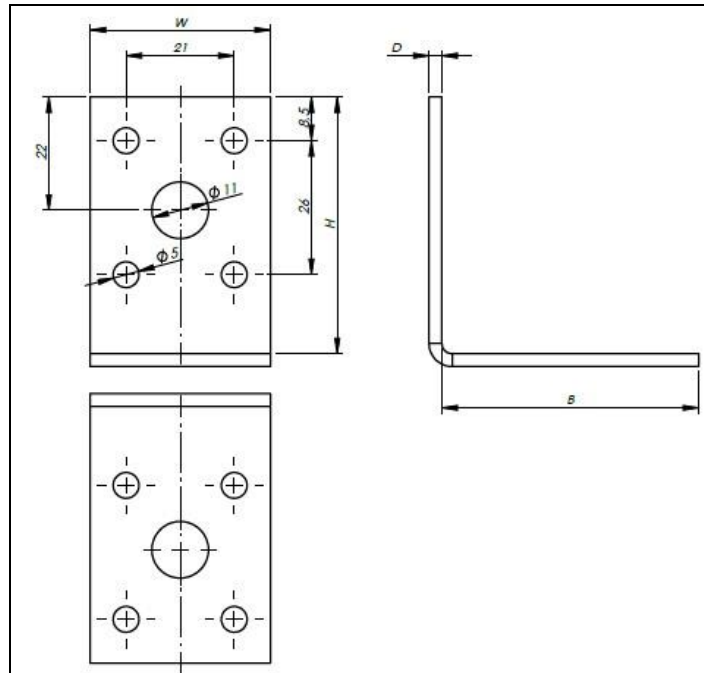

Figure 23 Type KL

Table 25 KL three-dimensional nailing plate symbols and dimensions

Symbol	Dimensions [mm]				Quantity of openings	
	W	H	B	D	Ø5	Ø11
KL 101	35	50	50	2.0	8	2

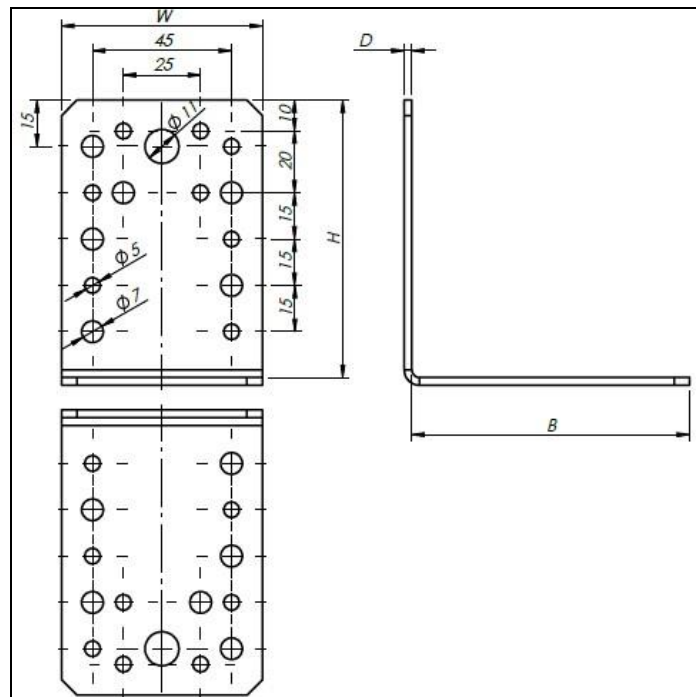

Figure 24 Type KL

Table 26 KL three-dimensional nailing plate symbols and dimensions

Symbol	Dimensions [mm]				Quantity of openings	
	W	H	B	D	Ø5	Ø11
KL 104	65	90	90	2.0	16	2

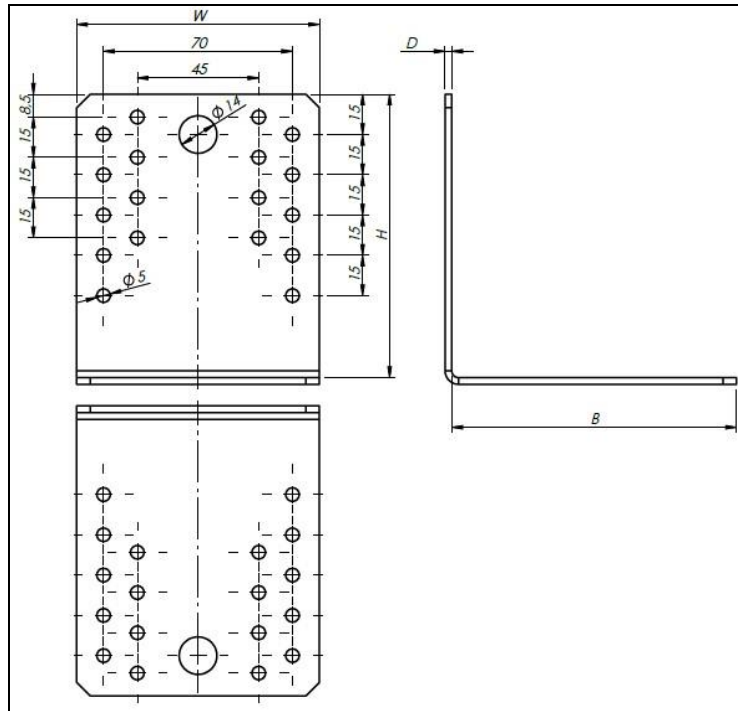

Figure 25 Type KL

Table 27 KL three-dimensional nailing plate symbols and dimensions

Symbol	Dimensions [mm]				Quantity of openings	
	W	H	B	D	Ø5	Ø14
KL 105	90	105	105	2.0	36	2

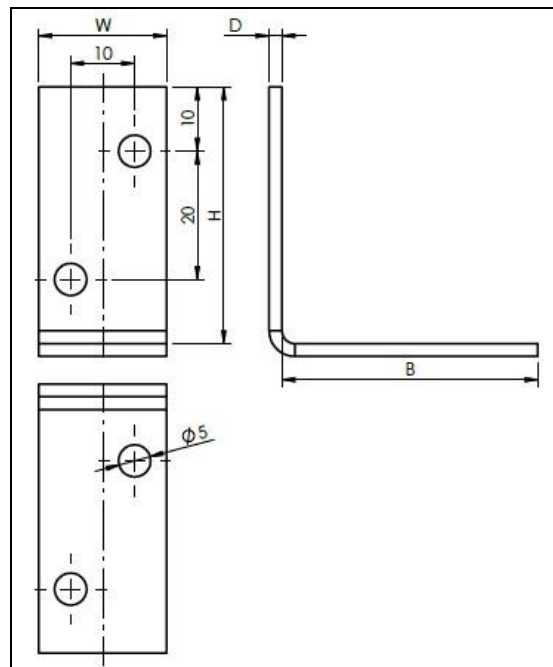

Figure 26 Type KM

Table 28 KM three-dimensional nailing plate symbols and dimensions

Symbol	Dimensions [mm]				Quantity of openings
	W	H	B	D	Ø5
KM 0	20	40	40	2.0	4

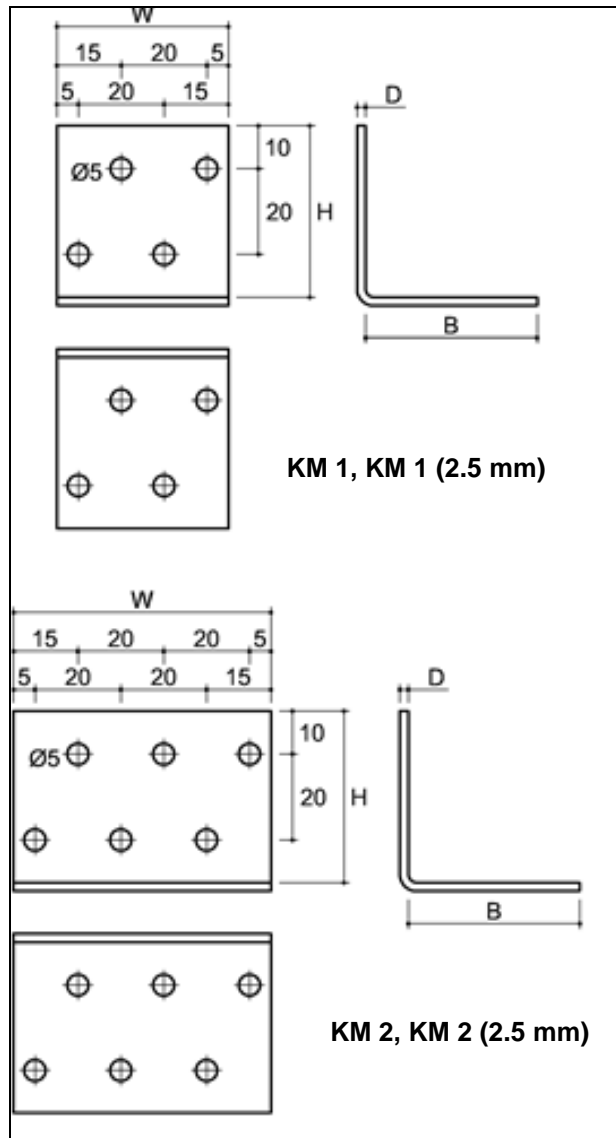

Figure 27 Type KM

Table 29 KM three-dimensional nailing plate symbols and dimensions

Symbol	Dimensions [mm]				Quantity of openings
	W	H	B	D	Ø 5
KM 1	40	40	40	2	8
KM 1 (2.5 mm)	40	40	40	2.5	8
KM 2	60	40	40	2	12
KM 2 (2.5 mm)	60	40	40	2.5	12

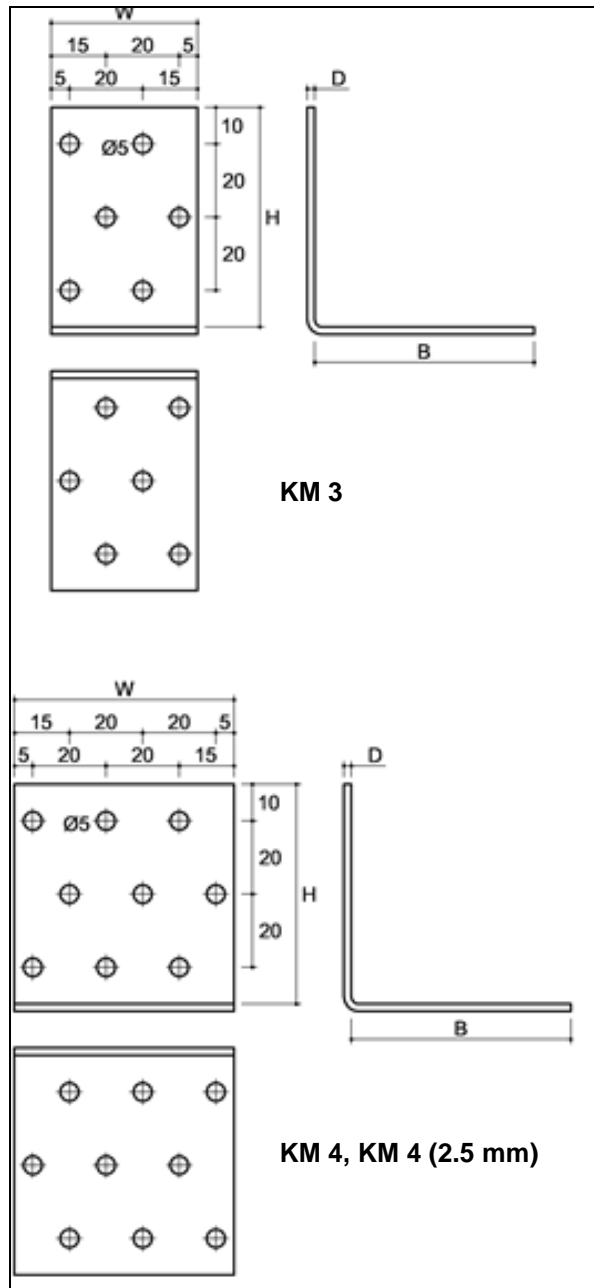

Figure 28 Type KM

Table 30 KM three-dimensional nailing plate symbols and dimensions

Symbol	Dimensions [mm]				Quantity of openings
	W	H	B	D	Ø 5
KM 3	40	60	60	2	12
KM 4	60	60	60	2	18
KM 4 (2.5 mm)	60	60	60	2.5	18

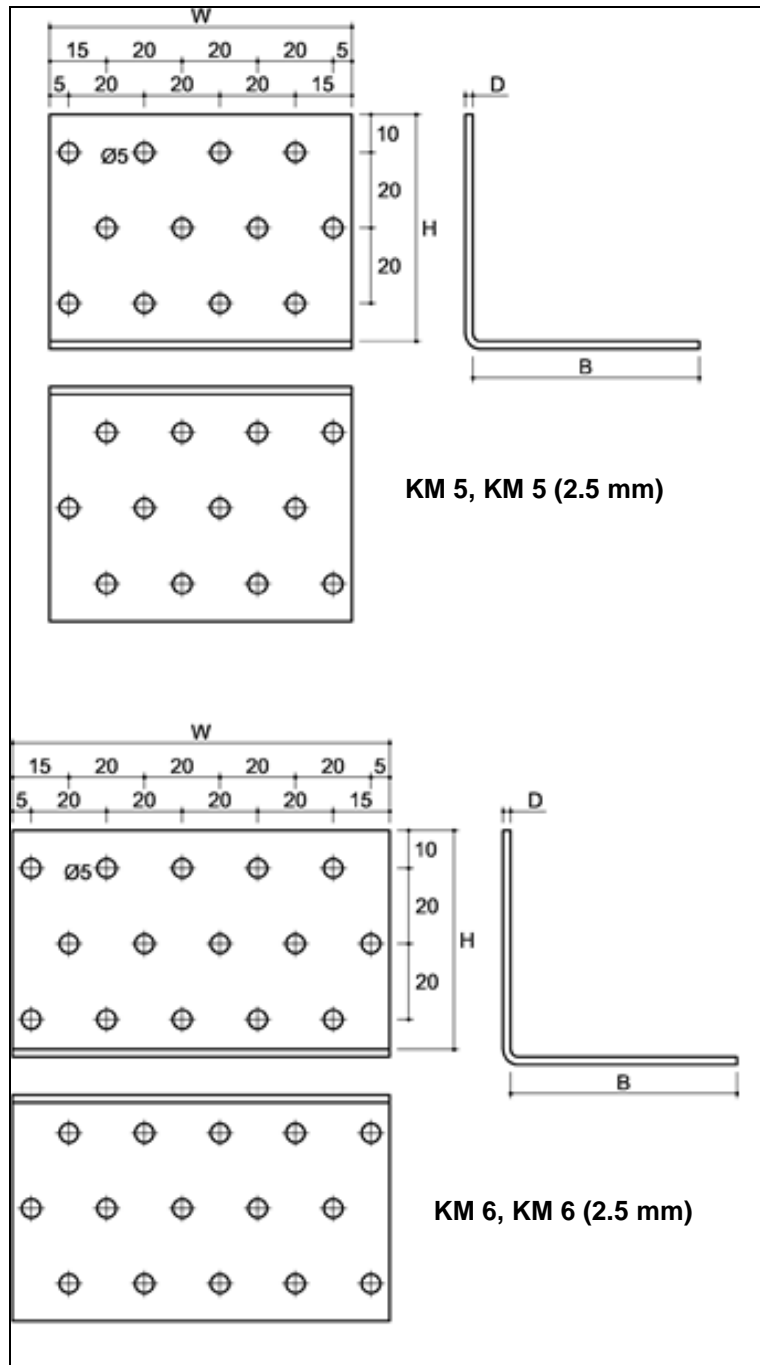

Figure 29 Type KM

Table 31 KM three-dimensional nailing plate symbols and dimensions

Symbol	Dimensions [mm]				Quantity of openings
	W	H	B	D	Ø 5
KM 5	80	60	60	2	24
KM 5 (2.5 mm)	80	60	60	2.5	24
KM 6	100	60	60	2	30
KM 6 (2.5 mm)	100	60	60	2.5	30

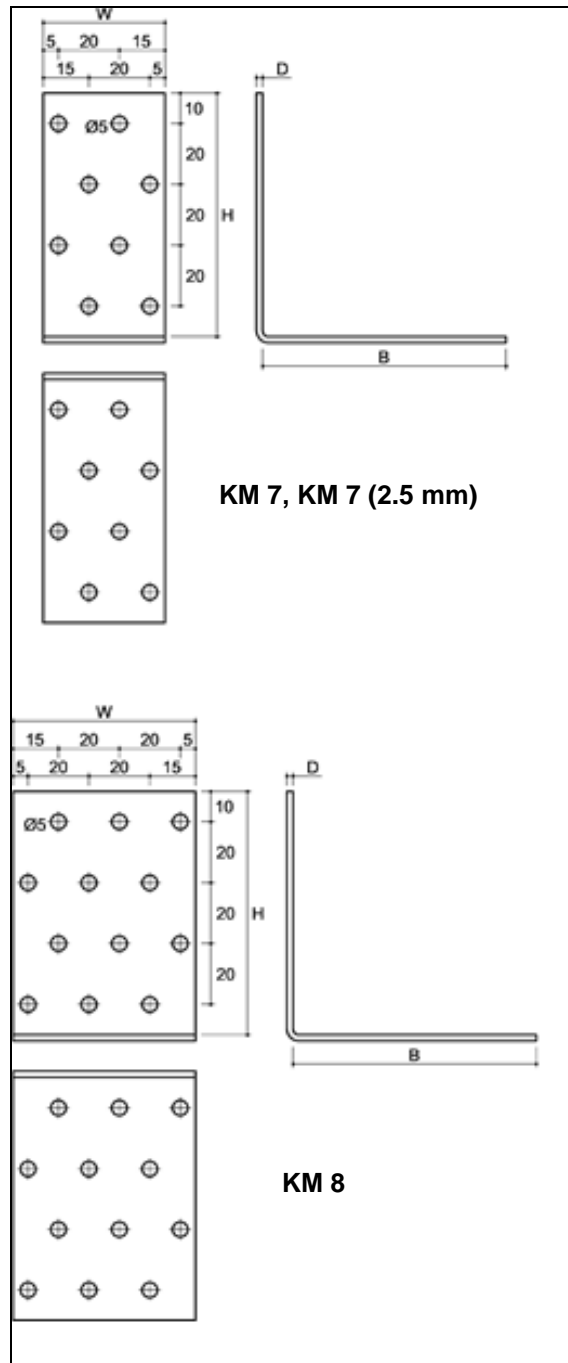

Figure 30 Type KM

Table 32 KM three-dimensional nailing plate symbols and dimensions

Symbol	Dimensions [mm]				Quantity of openings
	W	H	B	D	
KM 7	40	80	80	2	16
KM 7 (2.5 mm)	40	80	80	2.5	16
KM 8	60	80	80	2	24

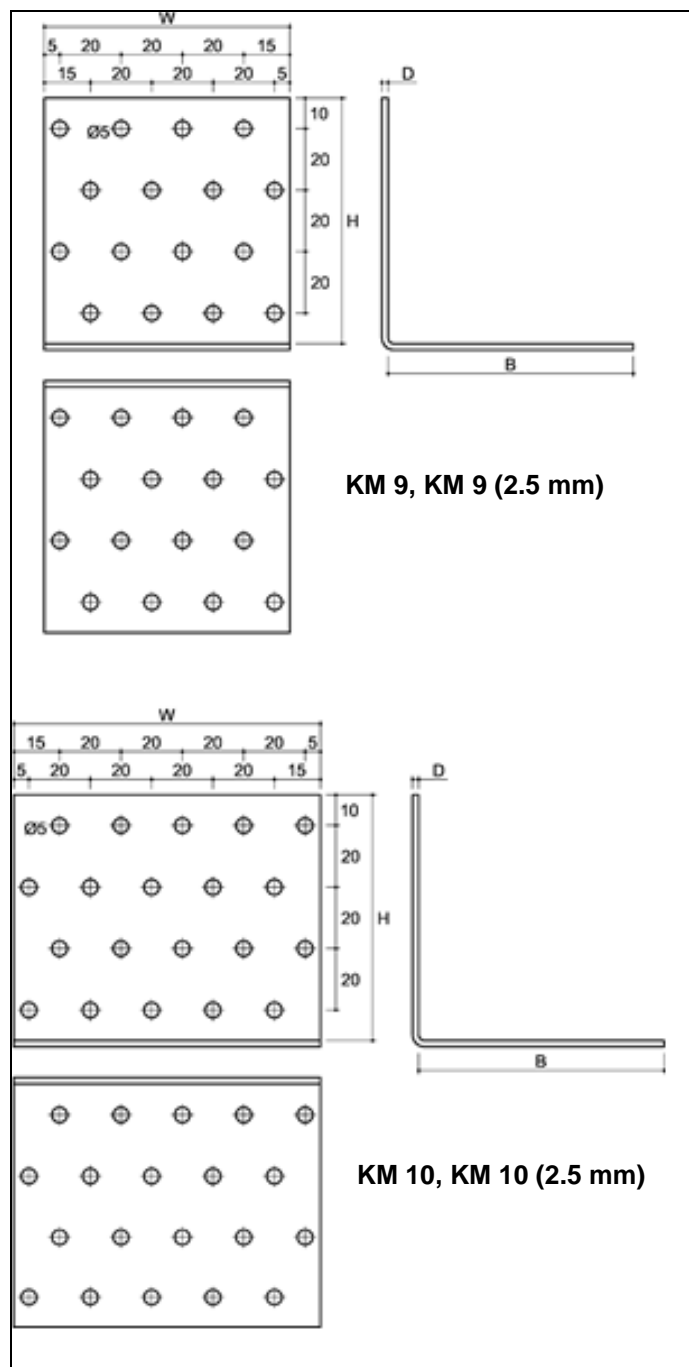

Figure 31 Type KM

Table 33 KM three-dimensional nailing plate symbols and dimensions

Symbol	Dimensions [mm]				Quantity of openings
	W	H	B	D	
KM 9	80	80	80	2	32
KM 9 (2.5 mm)	80	80	80	2.5	32
KM 10	100	80	80	2	40
KM 10(2.5 mm)	100	80	80	2.5	40

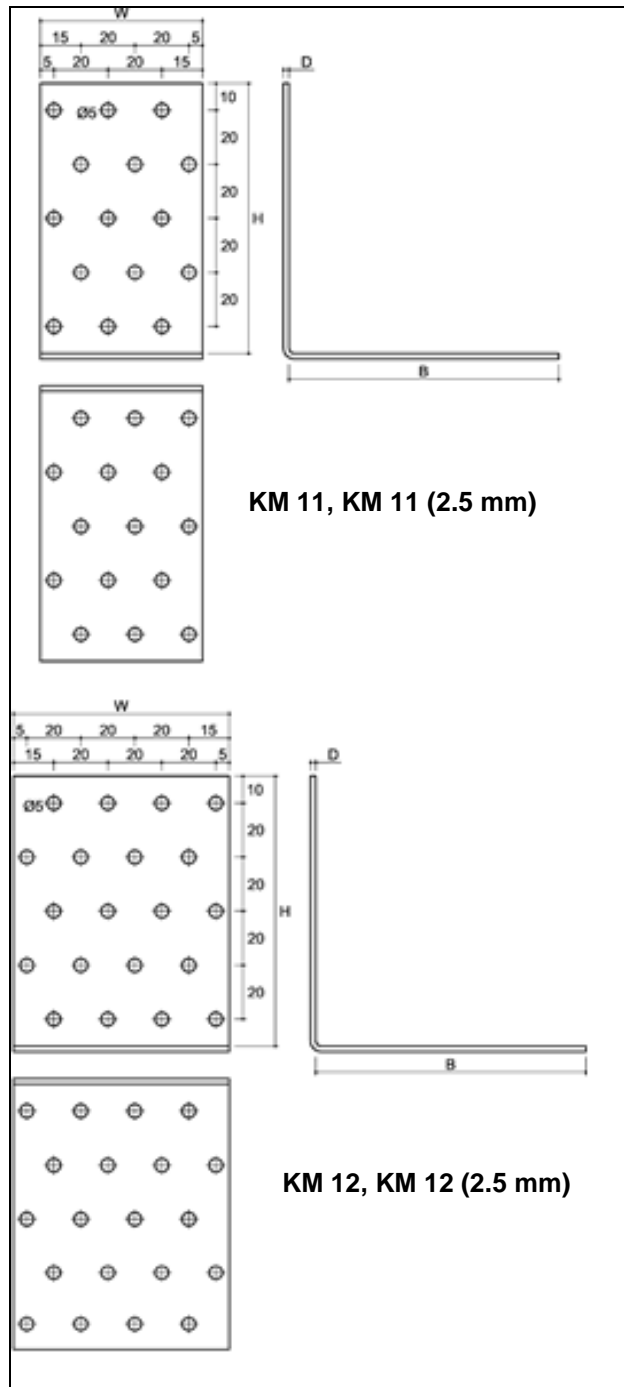

Figure 32 Type KM

Table 34 KM three-dimensional nailing plate symbols and dimensions

Symbol	Dimensions [mm]				Quantity of openings
	W	H	B	D	Ø 5
KM 11	60	100	100	2	30
KM 11 (2.5 mm)	60	100	100	2.5	30
KM 12	80	100	100	2	40
KM 12 (2.5 mm)	80	100	100	2.5	40

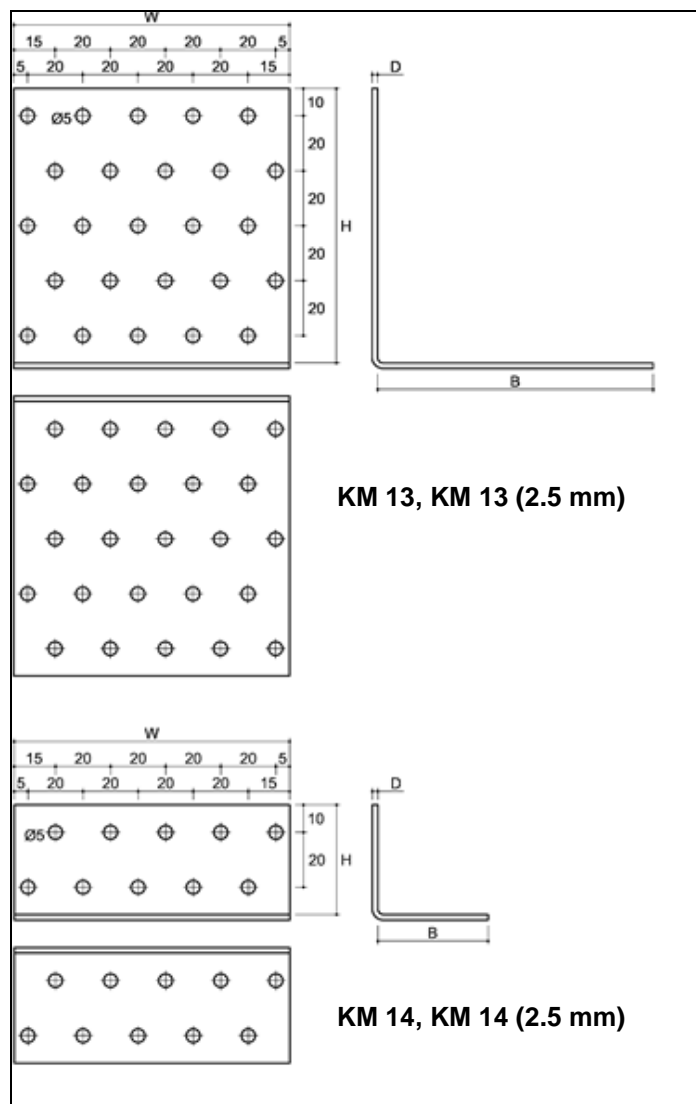

Figure 33 Type KM

Table 35 KM three-dimensional nailing plate symbols and dimensions

Symbol	Dimensions [mm]				Quantity of openings
	W	H	B	D	Ø 5
KM 13	100	100	100	2	50
KM 13 (2.5 mm)	100	100	100	2.5	50
KM 14	100	40	40	2	20
KM 14 (2.5 mm)	100	40	40	2.5	20

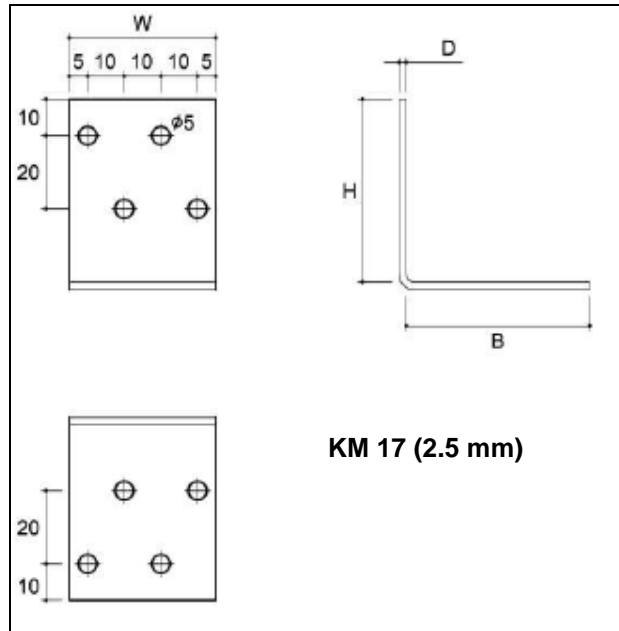

Figure 36 Type KM

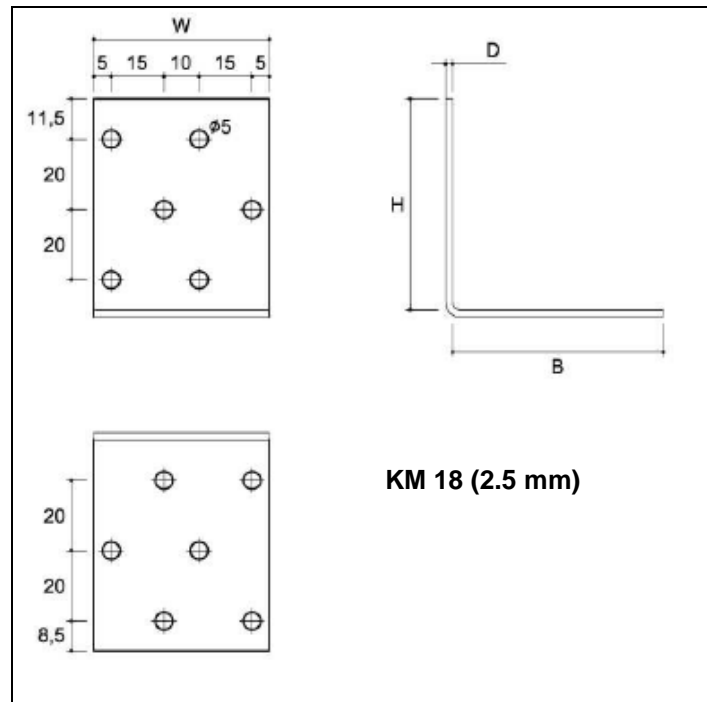

Figure 37 Type KM

Table 38 KM three-dimensional nailing plate symbols and dimensions

Symbol	Dimensions [mm]				Quantity of openings
	W	H	B	D	
KM 17 (2.5 mm)	40	50	50	2.5	8
KM 18 (2.5 mm)	50	60	60	2.5	12

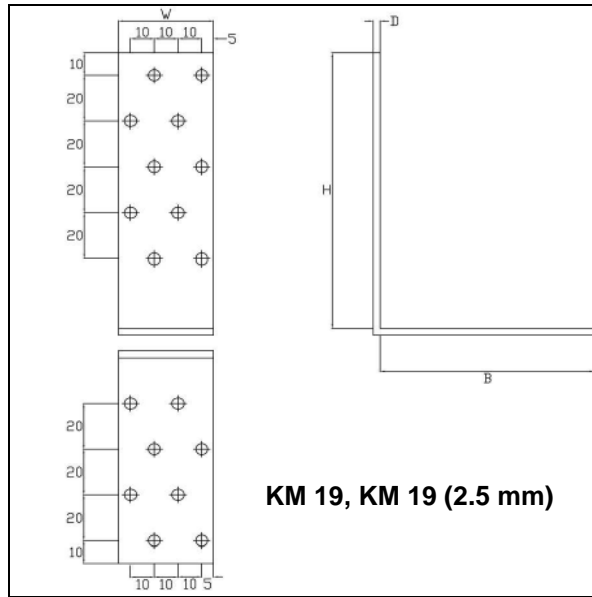

Figure 38 Type KM

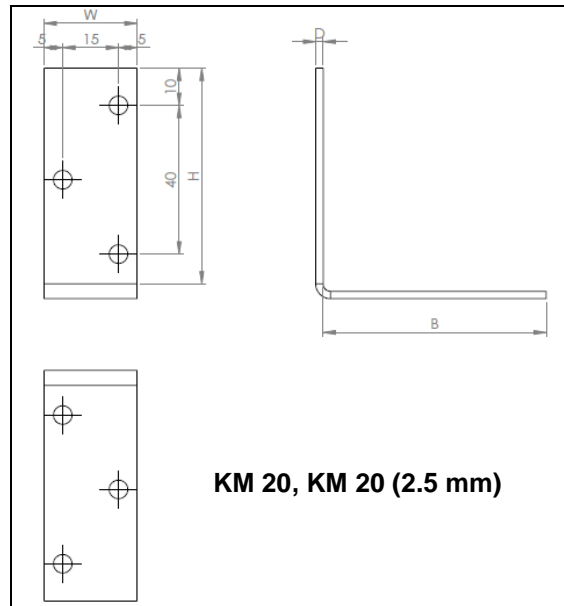

Figure 39 Type KM

Table 39 KM three-dimensional nailing plate symbols and dimensions

Symbol	Dimensions [mm]				Quantity of openings
	W	H	B	D	Ø 5
KM 19	40	120	90	2.0	18
KM 19 (2.5 mm)	40	120	90	2.5	18
KM 20	25	60	60	2.0	6
KM 20 (2.5 mm)	25	60	60	2.5	6

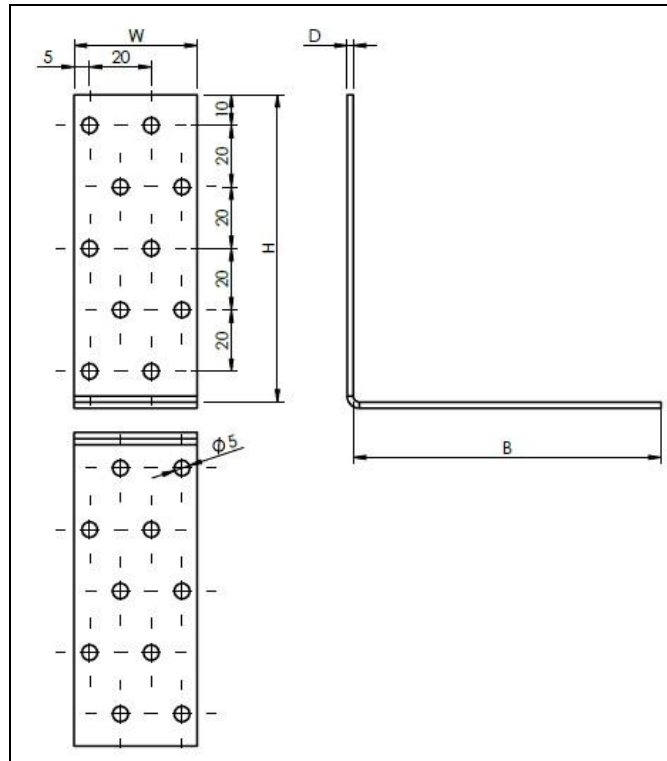

Figure 40 Type KM

Table 40 KM three-dimensional nailing plate symbols and dimensions

Symbol	Dimensions [mm]				Quantity of openings
	W	H	B	D	Ø5
KM 21	40	100	100	2.0	20

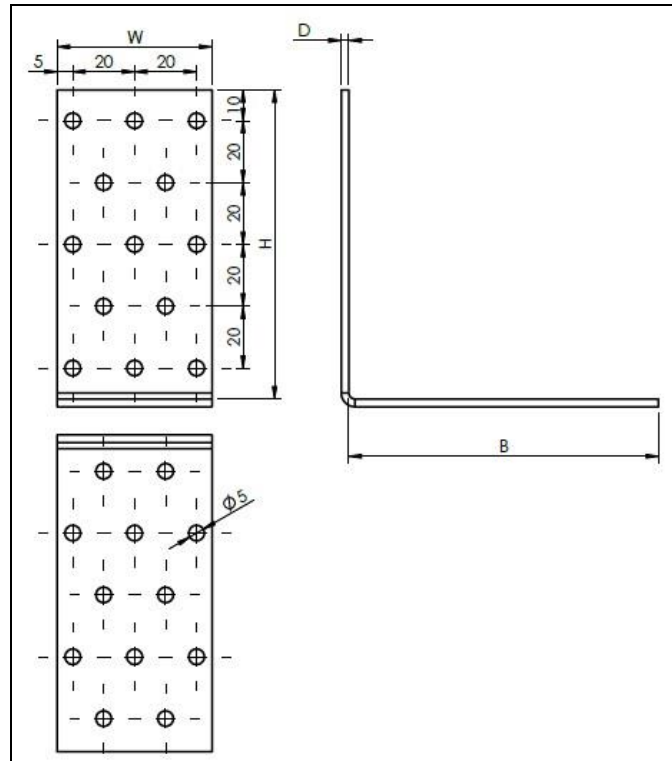

Figure 41 Type KM

Table 41 KM three-dimensional nailing plate symbols and dimensions

Symbol	Dimensions [mm]				Quantity of openings
	W	H	B	D	Ø5
KM 22 (2.5 mm)	50	100	100	2.5	25

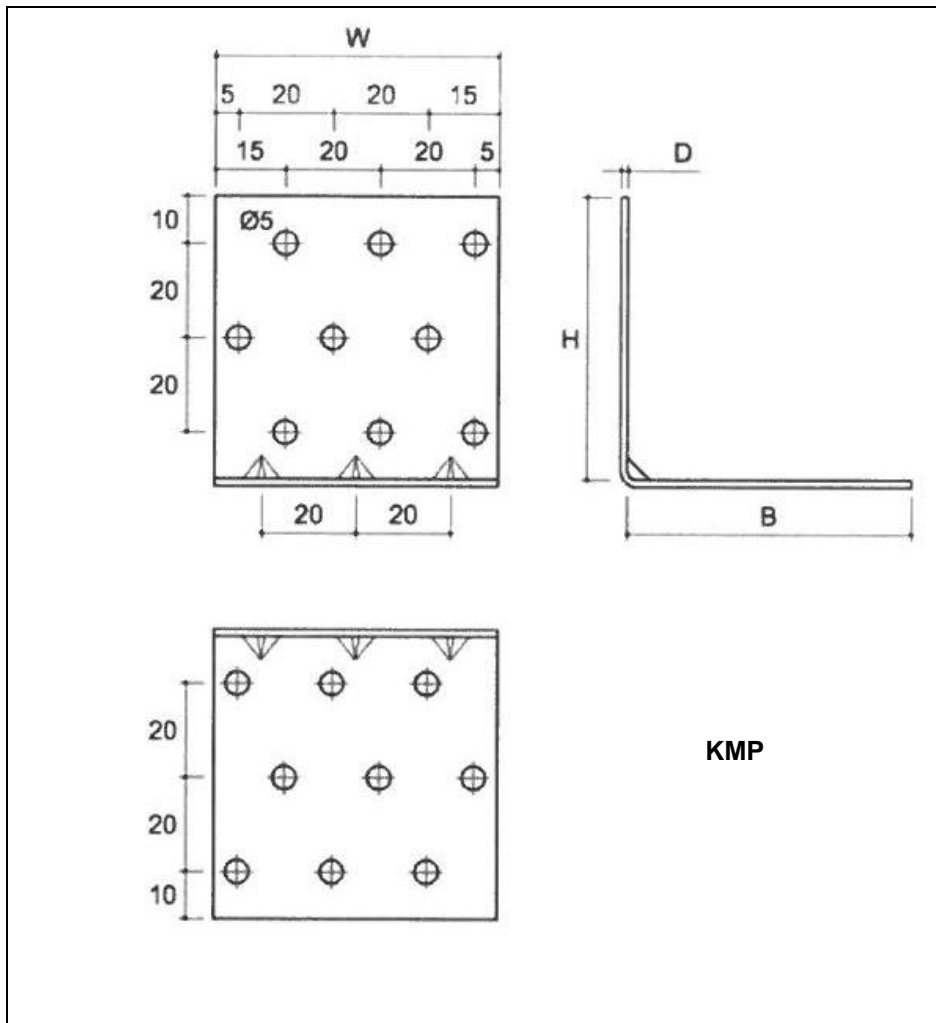

Figure 42 Type KMP

Table 42 KMP three-dimensional nailing plate symbols and dimensions

Symbol	Dimensions [mm]				Quantity of openings
	W	H	B	D	Ø 5
KMP1	40	40	40	1.5	8
KMP2	60	40	40	1.5	12
KMP3	80	40	40	1.5	16
KMP4	40	60	60	1.5	12
KMP5	60	60	60	1.5	18
KMP6	80	60	60	1.5	24
KMP7	40	80	80	1.5	16
KMP8	60	80	80	1.5	24
KMP9	80	80	80	1.5	32

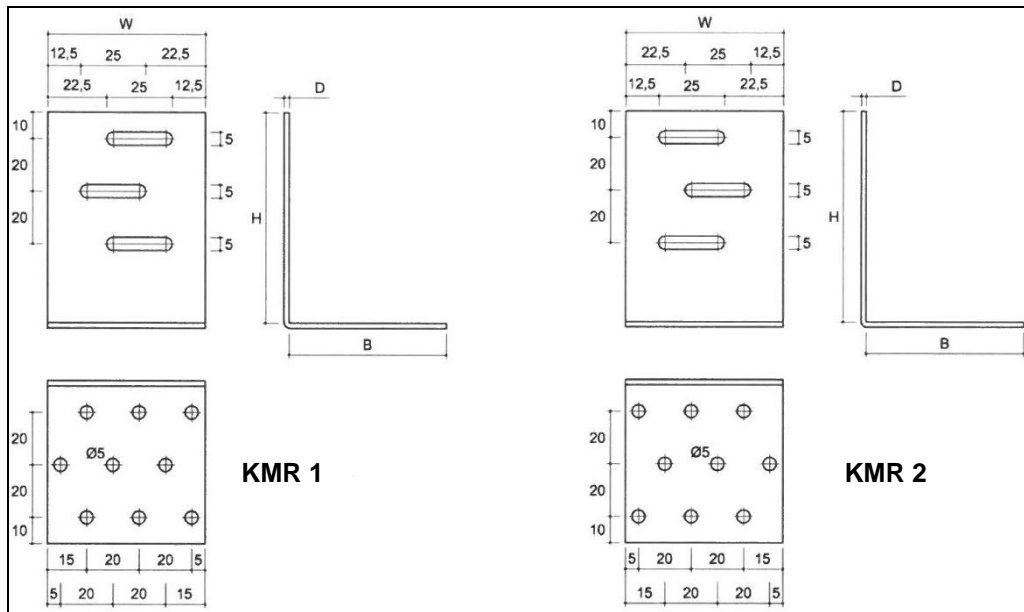

Figure 43 Type KMR

Table 43 KMR three-dimensional nailing plate symbols and dimensions

Symbol	Dimensions [mm]				Quantity of openings
	W	H	B	D	Ø 5
KMR 1	60	80	60	2	9
KMR 2	60	80	60	2	9

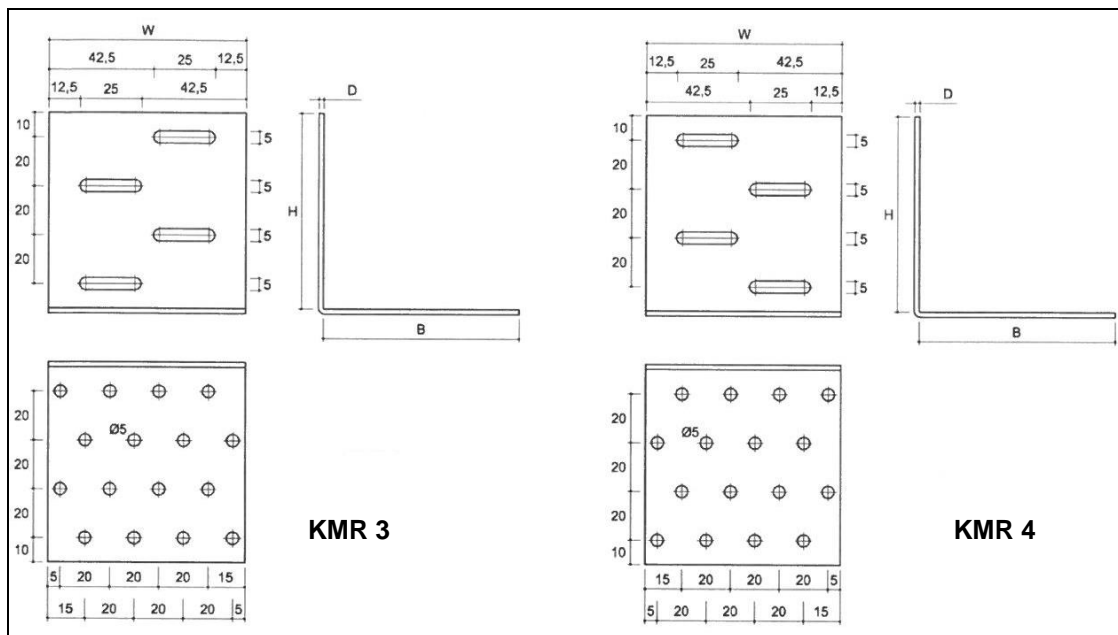

Figure 44 Type KMR

Table 44 KMR three-dimensional nailing plate symbols and dimensions

Symbol	Dimensions [mm]				Quantity of openings
	W	H	B	D	Ø 5
KMR 3	80	80	80	2	16
KMR 4	80	80	80	2	16

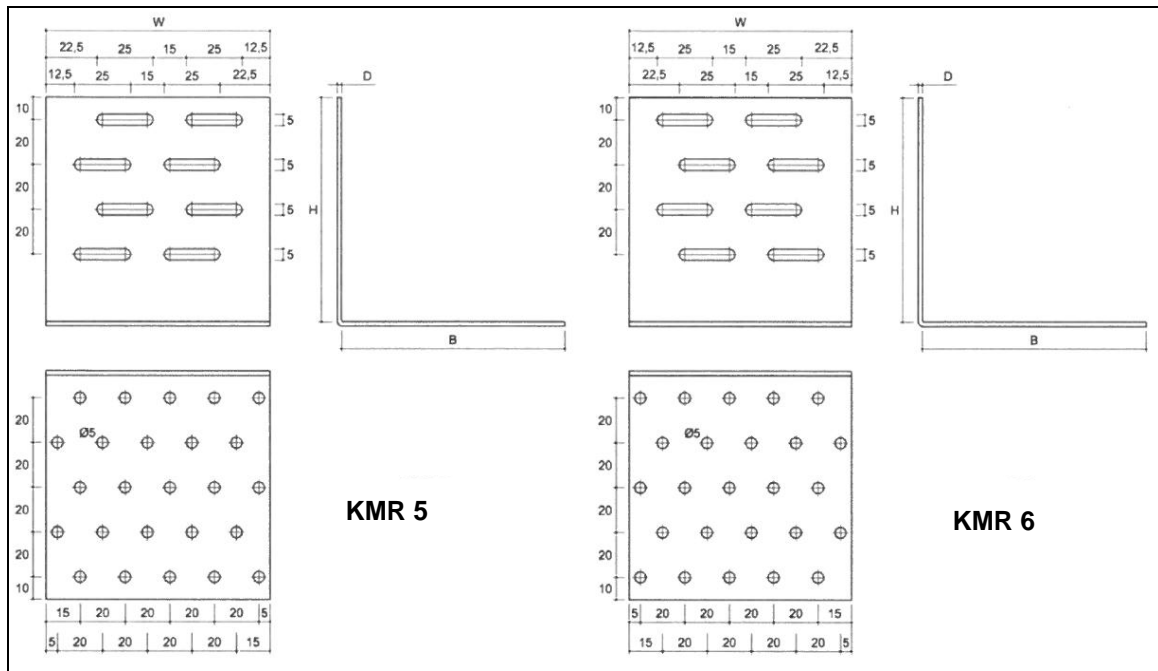

Figure 45 Type KMR

Table 45 KMR three-dimensional nailing plate symbols and dimensions

Symbol	Dimensions [mm]				Quantity of openings
	W	H	B	D	Ø 5
KMR 5	100	100	100	2	25
KMR 6	100	100	100	2	25

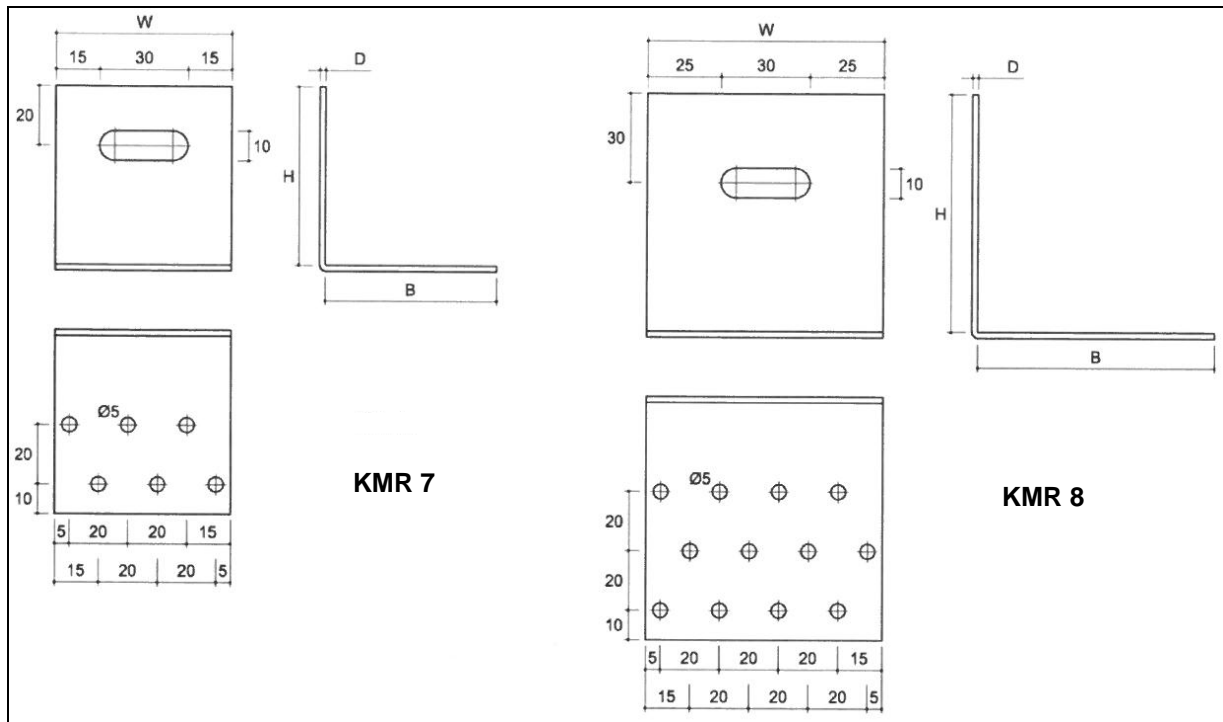

Figure 46 Type KMR

Table 46 KMR three-dimensional nailing plate symbols and dimensions

Symbol	Dimensions [mm]				Quantity of openings
	W	H	B	D	Ø 5
KMR 7	60	60	60	2	6
KMR 8	80	80	80	2	12

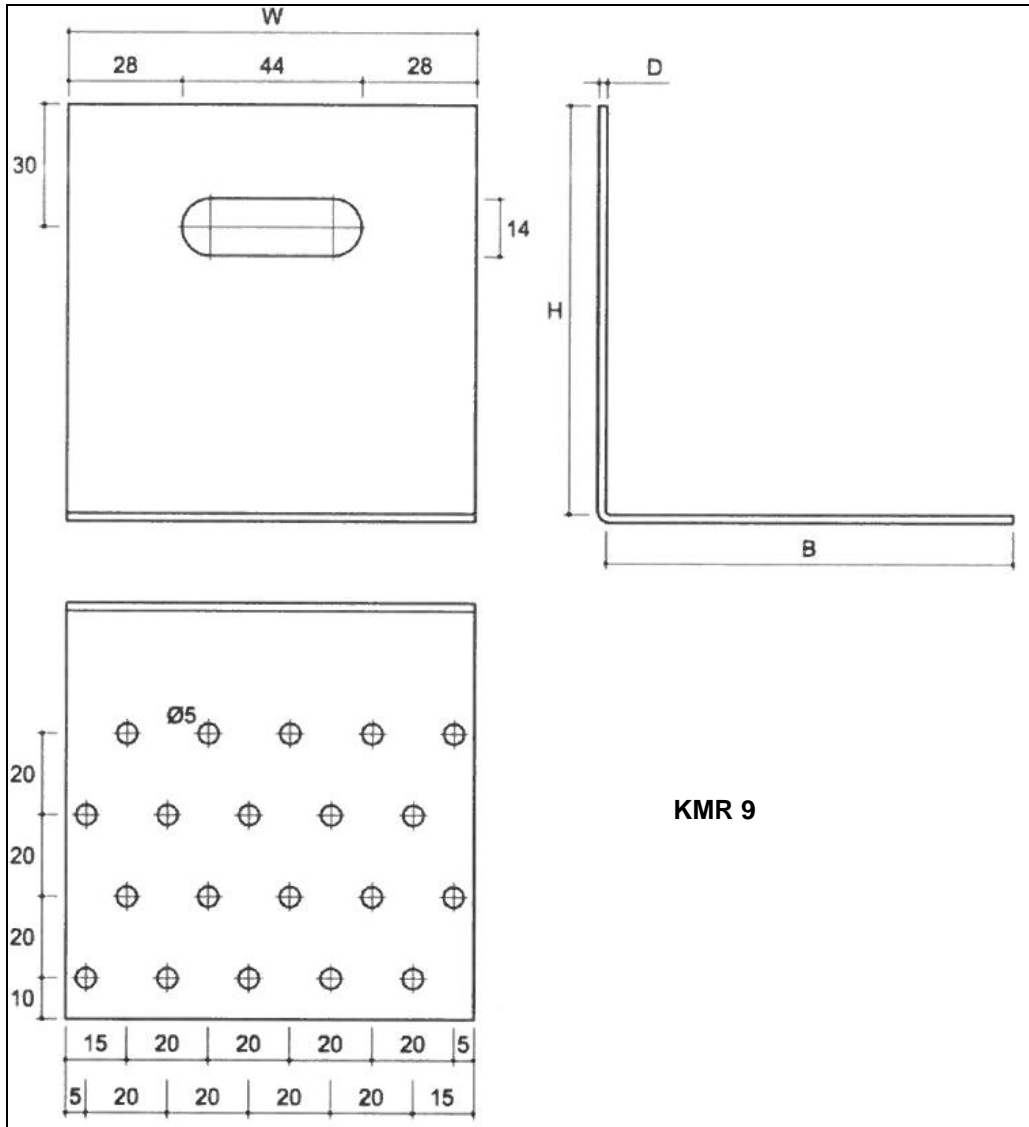

Figure 47 Type KMR

Table 47 KMR three-dimensional nailing plate symbols and dimensions

Symbol	Dimensions [mm]				Quantity of openings
	W	H	B	D	Ø 5
KMR 9	100	100	100	2	20

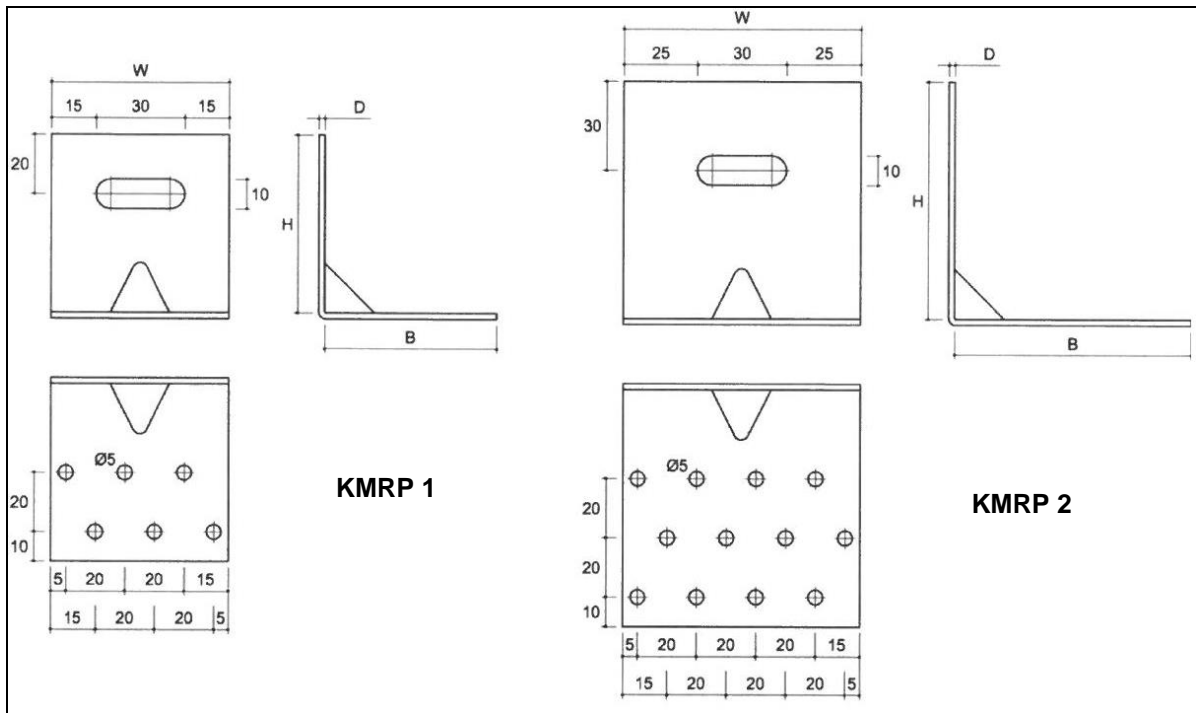

Figure 48 Type KMRP

Table 48 KMRP three-dimensional nailing plate symbols and dimensions

Symbol	Dimensions [mm]				Quantity of openings
	W	H	B	D	Ø 5
KMRP 1	60	60	60	2	6
KMRP 2	80	80	80	2	12

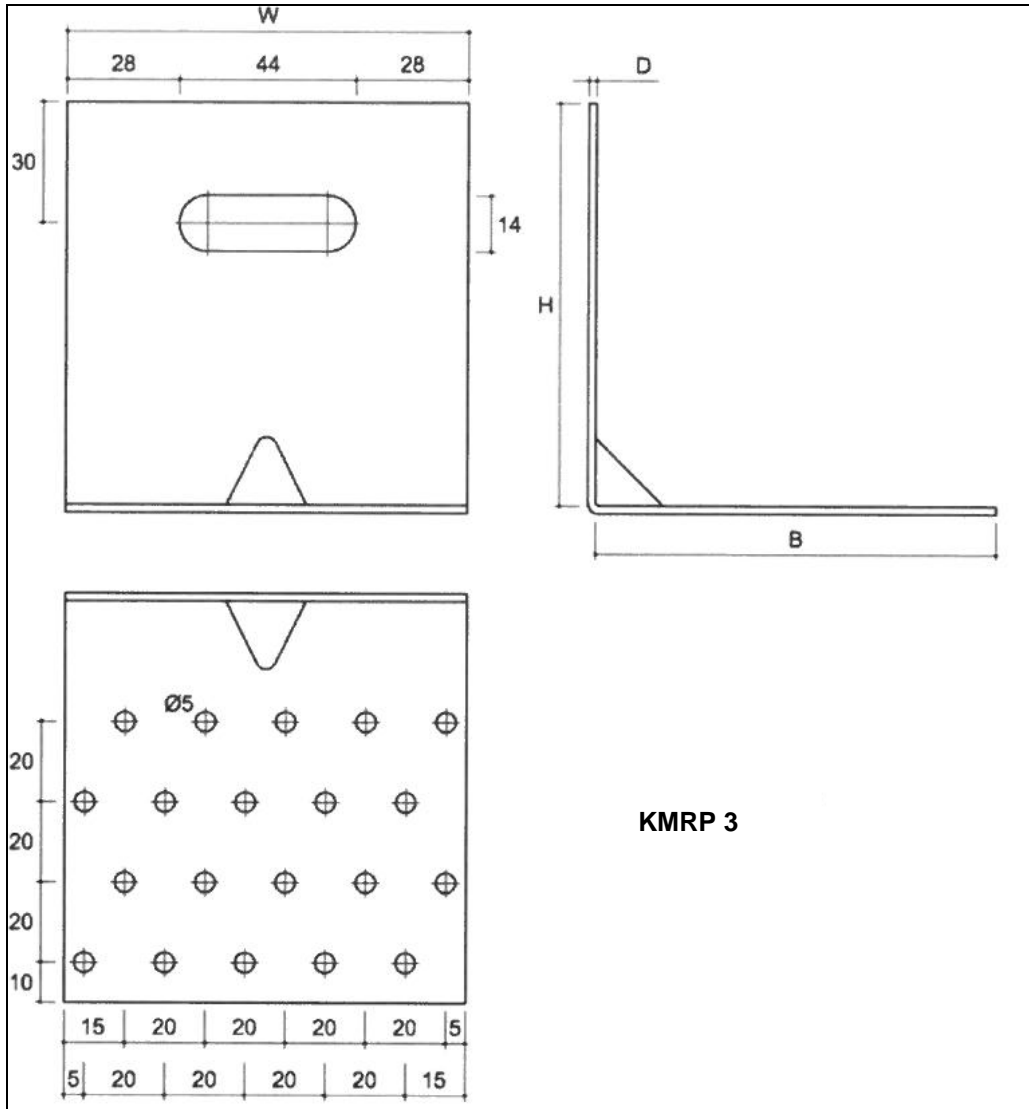

Figure 49 Type KMRP

Table 49 KMRP three-dimensional nailing plate symbols and dimensions

Symbol	Dimensions [mm]				Quantity of openings
	W	H	B	D	$\varnothing 5$
KMRP 3	100	100	100	2	20

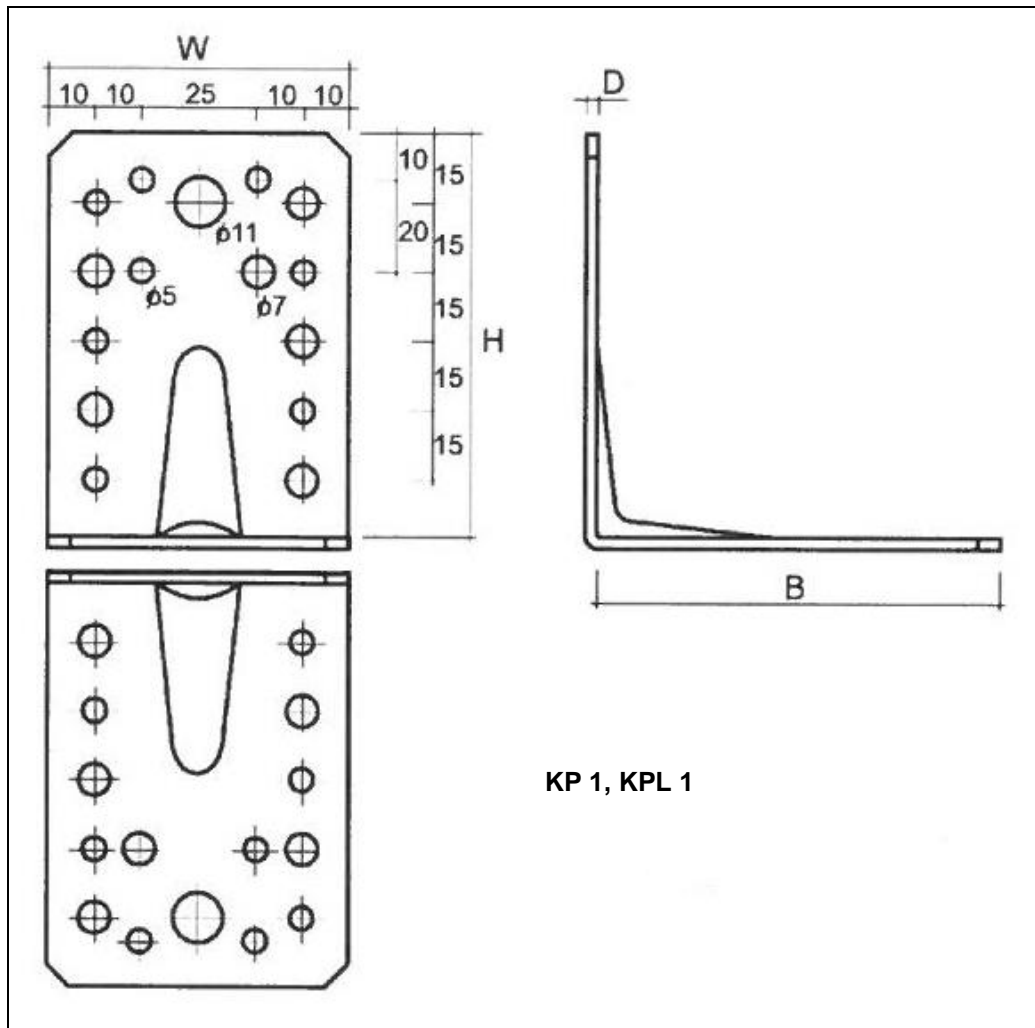

Figure 50 Type KP, KPL

Table 50 KP, KPL three-dimensional nailing plate symbols and dimensions

Symbol	Dimensions [mm]				Quantity of openings			
	W	H	B	D	Ø 5	Ø 7	Ø 11	Ø 14
KP 1	65	90	90	2.5	16	12	2	-
KPL 1	65	90	90	2.0	16	12	2	-

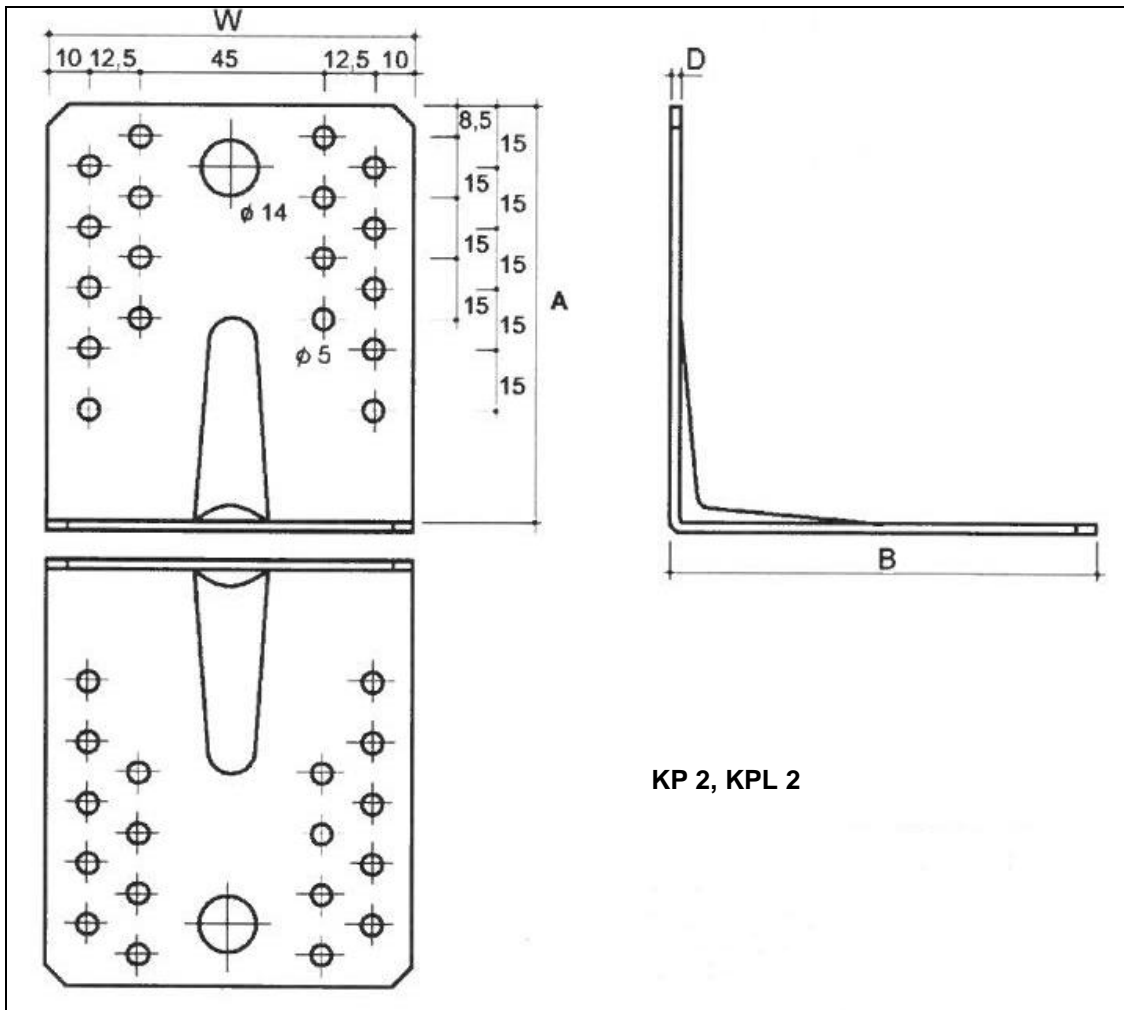
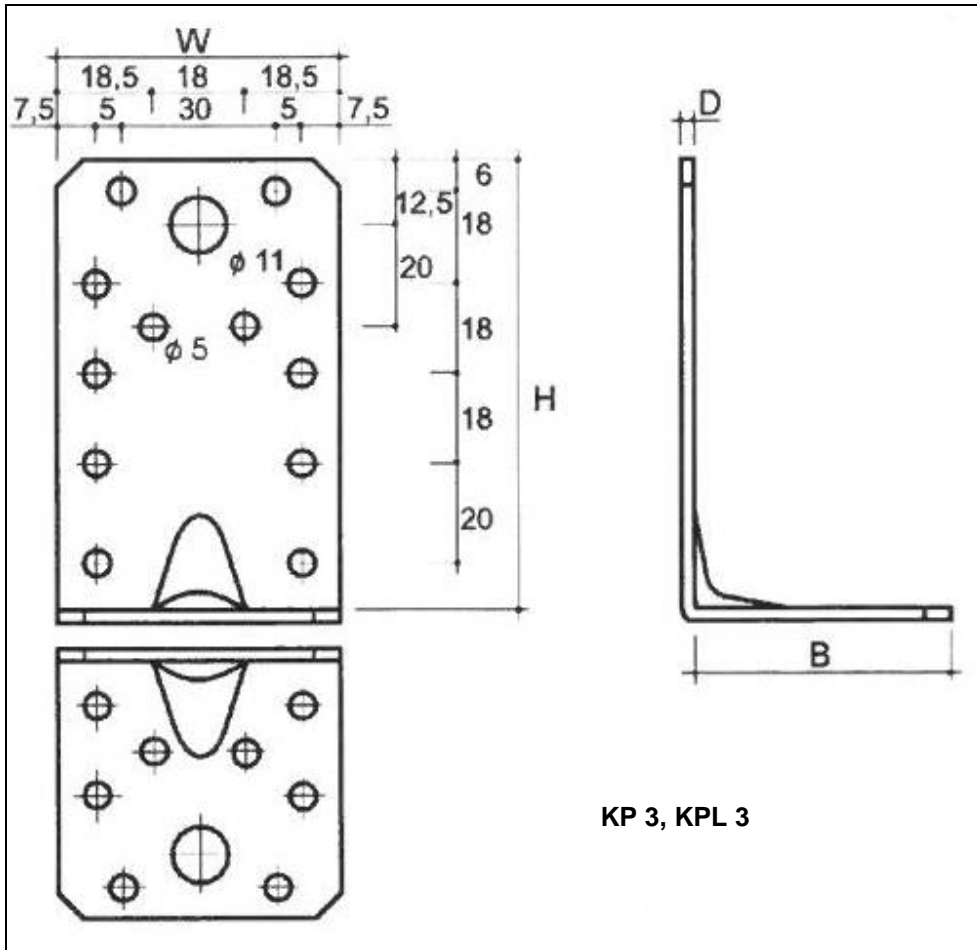

Figure 51 Type KP, KPL

Table 51 KP, KPL three-dimensional nailing plate symbols and dimensions

Symbol	Dimensions [mm]				Quantity of openings			
	W	H	B	D	Ø 5	Ø 7	Ø 11	Ø 14
KP 2	90	105	105	2.5	36	-	-	2
KPL 2	90	105	105	2.0	36	-	-	2



KP 3, KPL 3

Figure 52 Type KP, KPL

Table 52 KP, KPL three-dimensional nailing plate symbols and dimensions

Symbol	Dimensions [mm]				Quantity of openings			
	W	H	B	D	Ø 5	Ø 7	Ø 11	Ø 14
KP 3	55	90	50	2.5	20	-	2	-
KPL 3	55	90	50	2.0	20	-	2	-

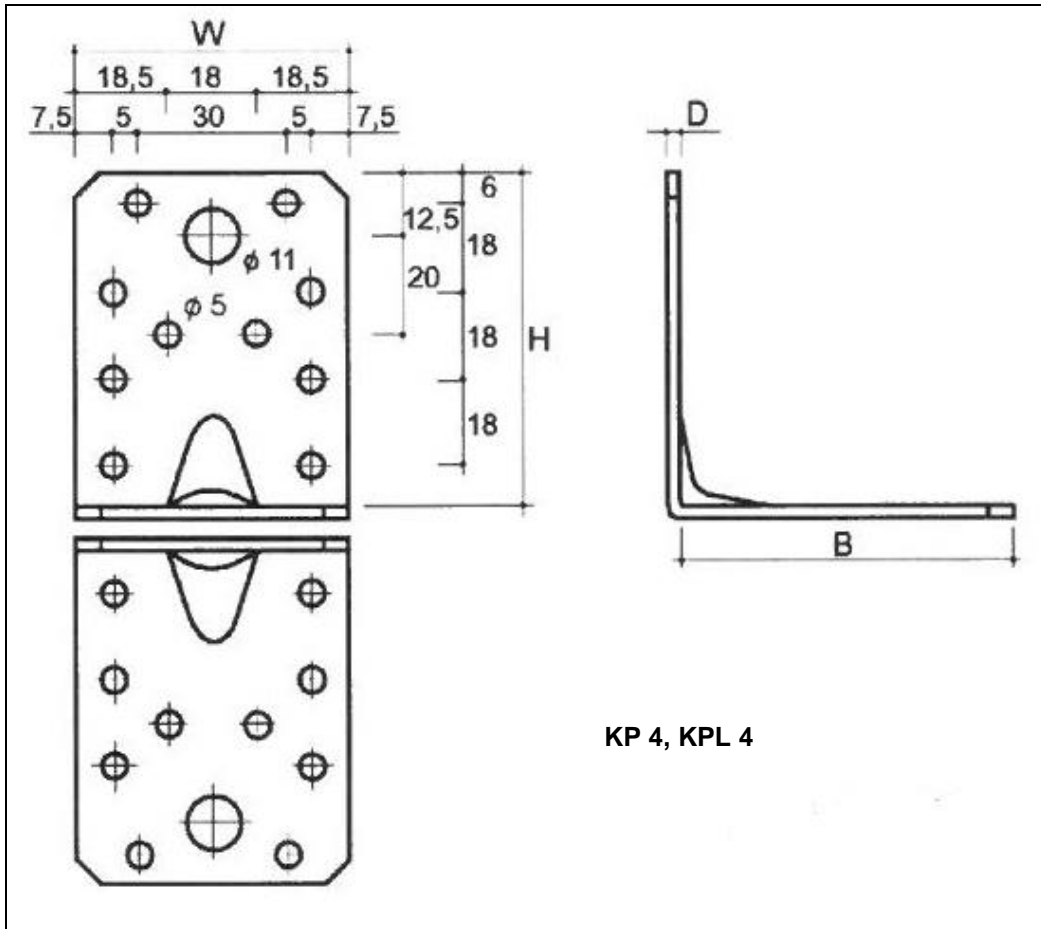

Figure 53 Type KP, KPL

Table 53 KP, KPL three-dimensional nailing plate symbols and dimensions

Symbol	Dimensions [mm]				Quantity of openings			
	W	H	B	D	Ø 5	Ø 7	Ø 11	Ø 14
KP 4	55	70	70	2.5	20	-	2	-
KPL 4	55	70	70	2.0	20	-	2	-

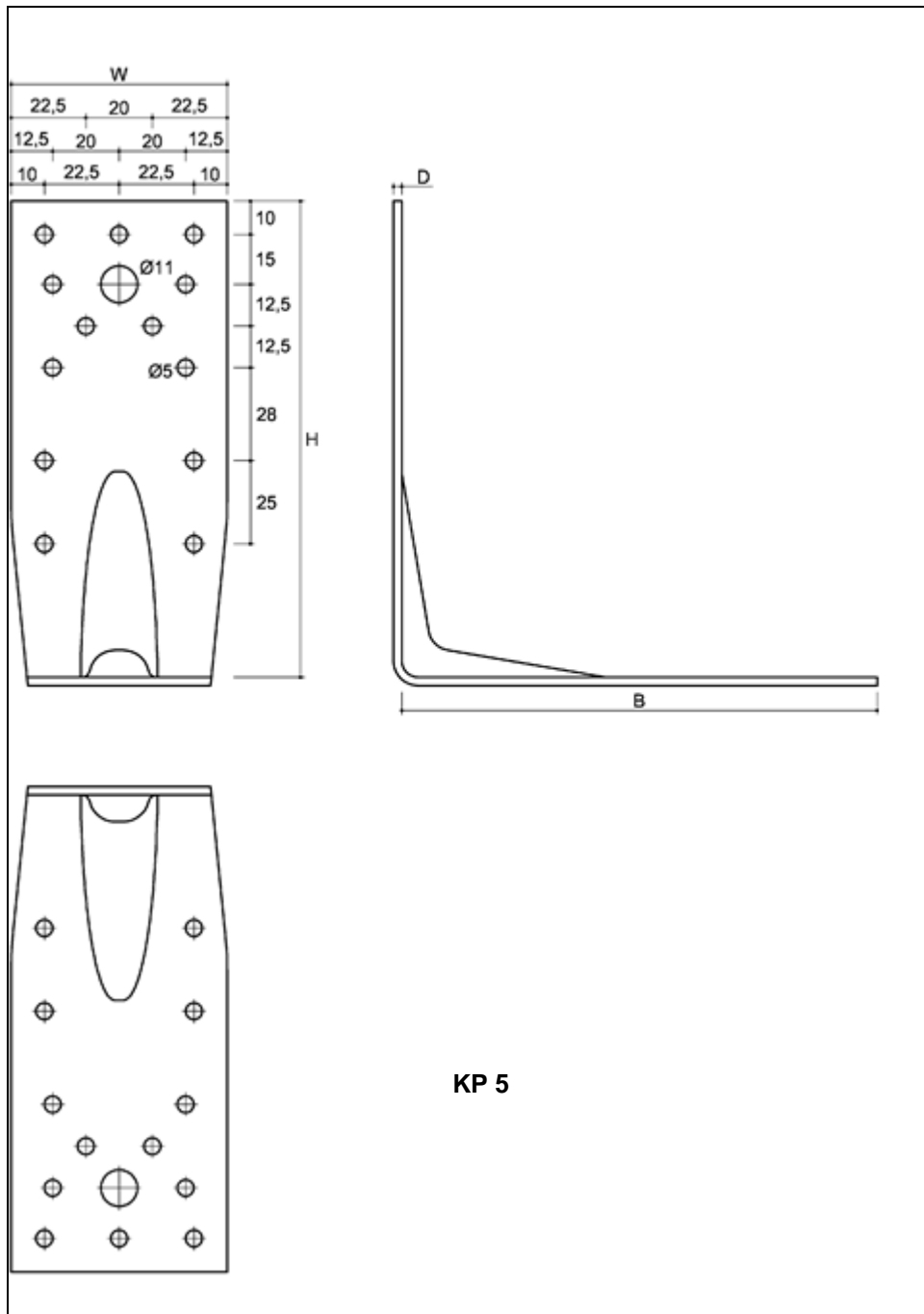

Figure 54 Type KP

Table 54 KP three-dimensional nailing plate symbols and dimensions

Symbol	Dimensions [mm]				Quantity of openings			
	W	H	B	D	Ø 5	Ø 7	Ø 11	Ø 14
KP 5	65	140	140	2.5	26	2	-	-

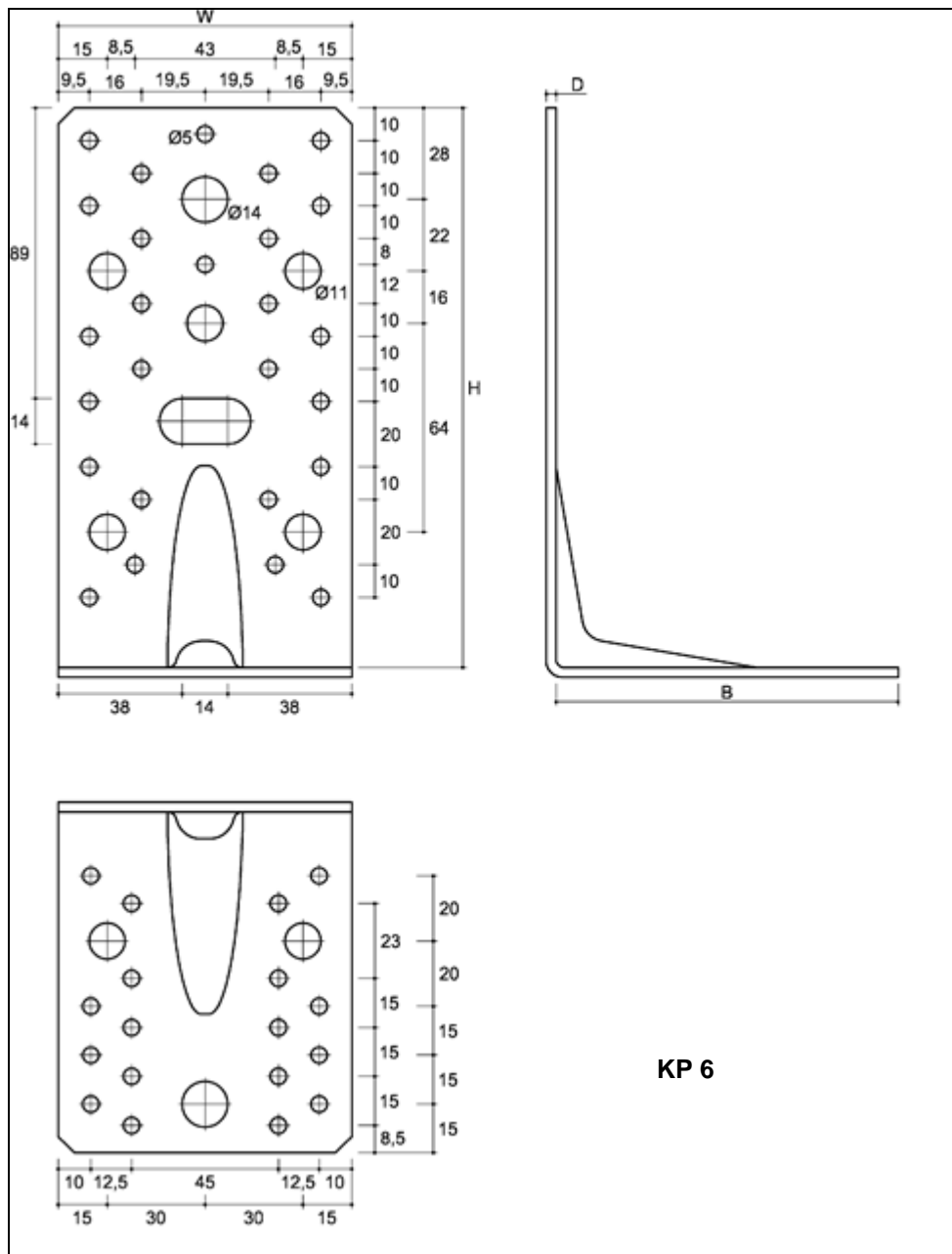

Figure 55 Type KP

Table 55 KP three-dimensional nailing plate symbols and dimensions

Symbol	Dimensions [mm]				Quantity of openings			
	W	H	B	D	Ø 5	Ø 7	Ø 11	Ø 14
KP 6	90	172	105	3	44	7	-	2

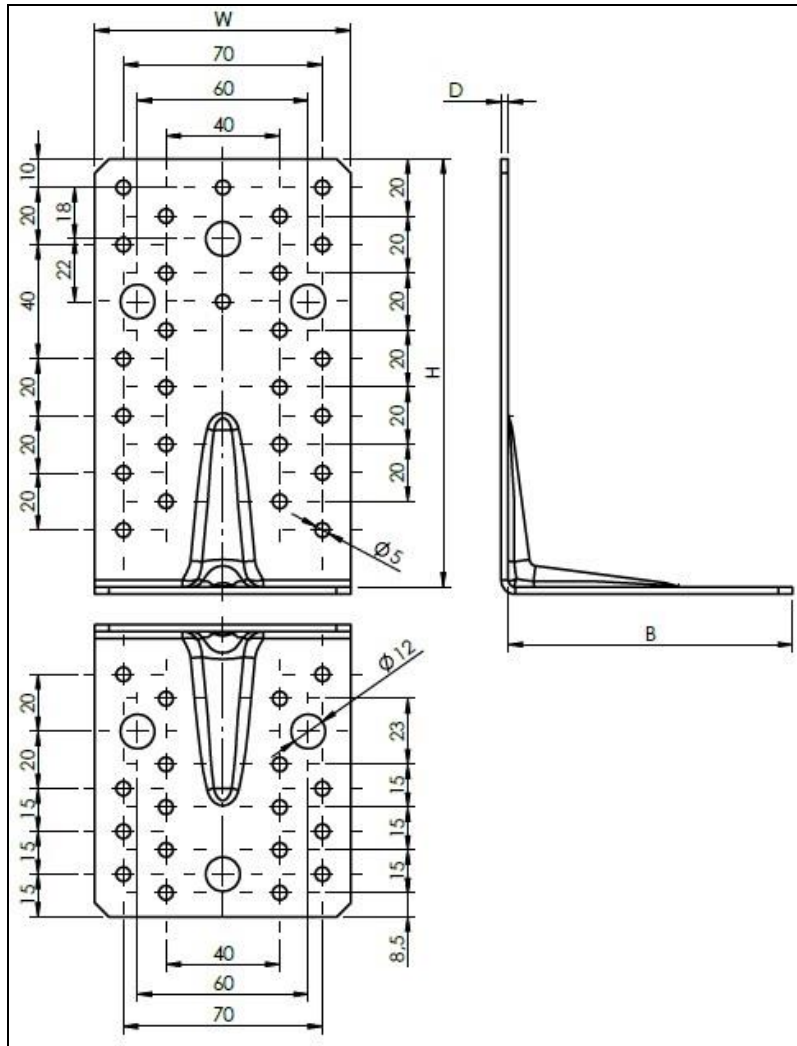

Figure 56 Type KP 10, KPL 10

Table 56 KP, KPL three-dimensional nailing plate symbols and dimensions

Symbol	Dimensions [mm]				Quantity of openings	
	W	H	B	D	Ø5	Ø12
KP 10	90	150	100	2.5	44	6
KPL 10	90	150	100	2.0	44	6

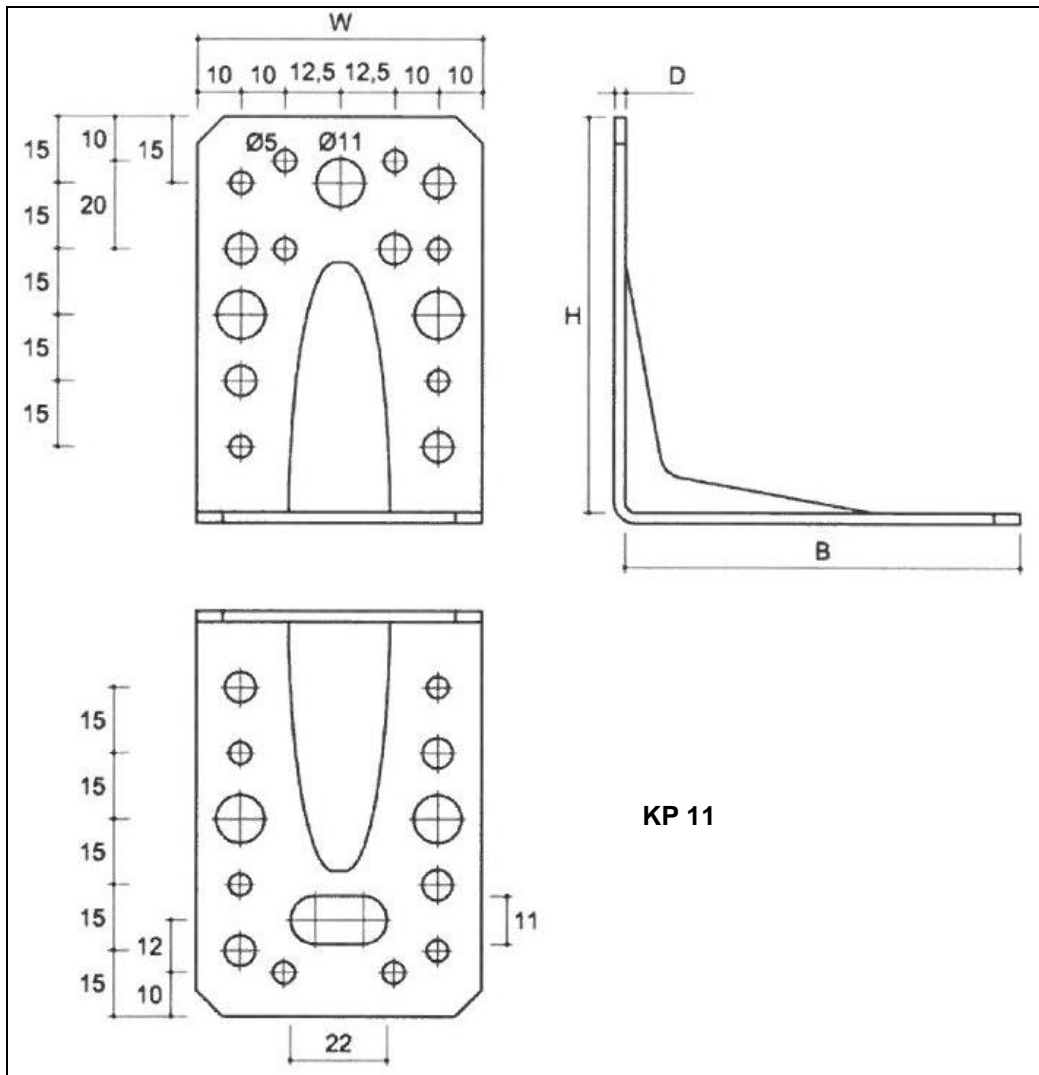

Figure 57 Type KP

Table 57 KP three-dimensional nailing plate symbols and dimensions

Symbol	Dimensions [mm]				Quantity of openings			
	W	H	B	D	$\varnothing 5$	$\varnothing 7$	$\varnothing 11$	$\varnothing 14$
KP 11	65	90	90	2.5	13	9	5	-

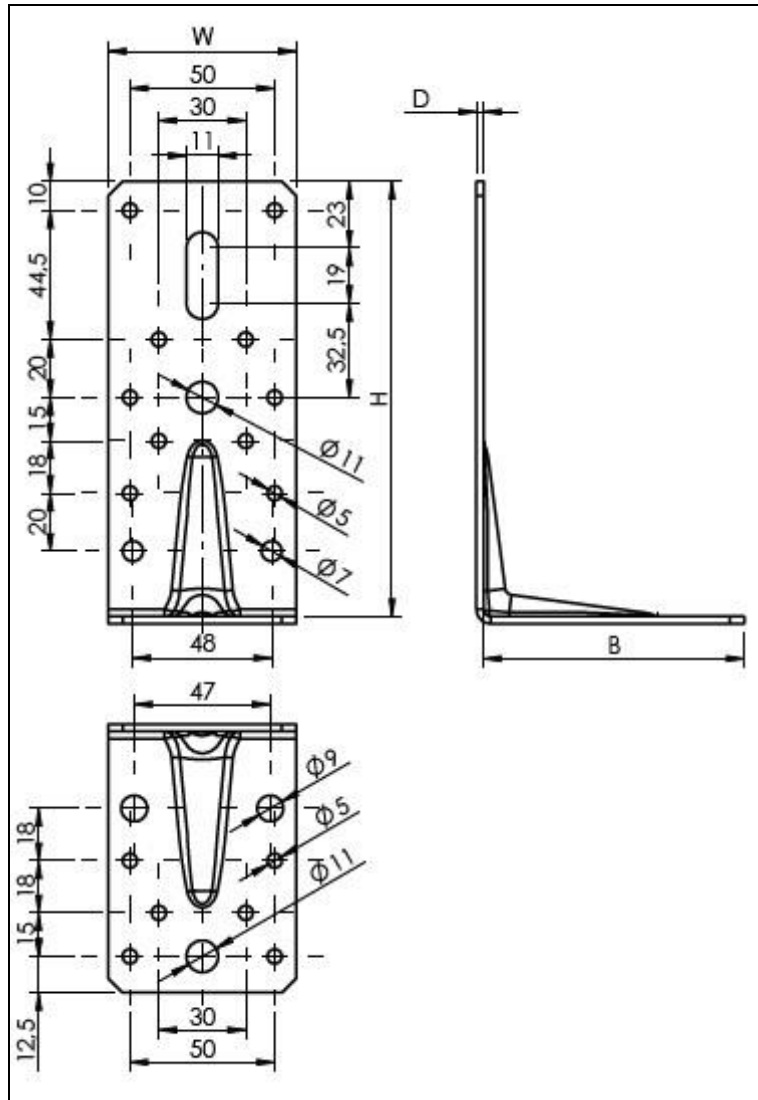

Figure 58 Type KP 12, KPL 12

Table 58 KP, KPL three-dimensional nailing plate symbols and dimensions

Symbol	Dimensions [mm]				Quantity of openings			
	W	H	B	D	Ø5	Ø7	Ø9	Ø11
KP 12	65	150	90	2.5	16	2	2	2
KPL 12	65	150	90	2.0	16	2	2	2

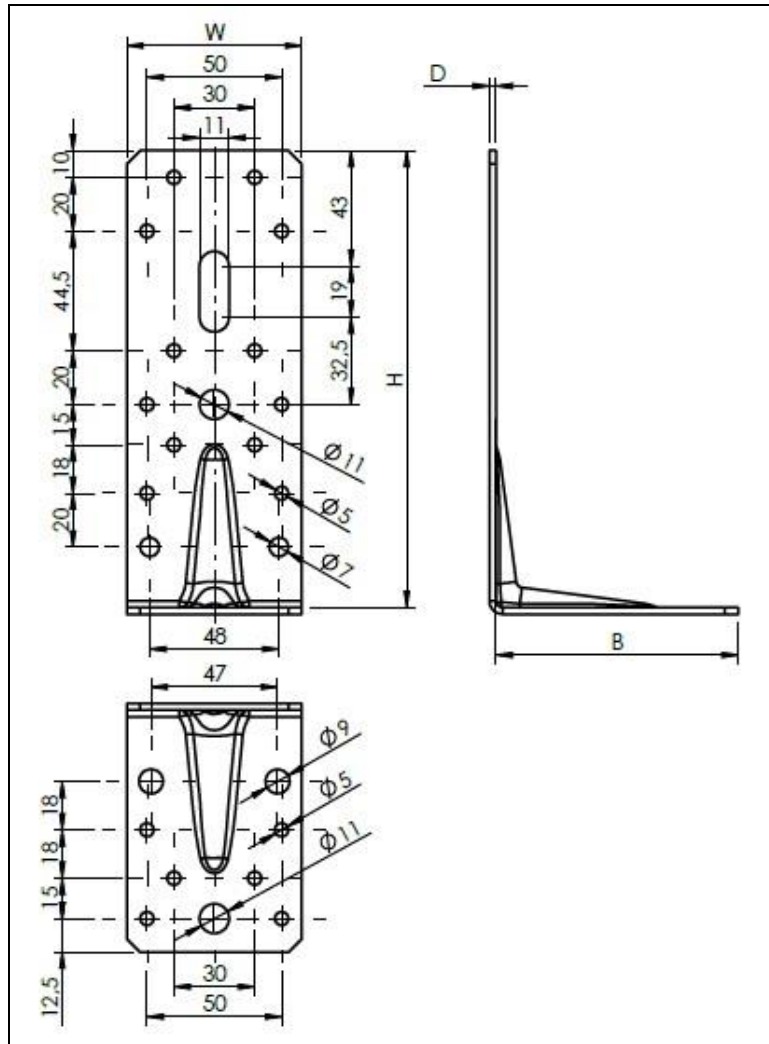

Figure 59 Type KP 13

Table 59 KP three-dimensional nailing plate symbols and dimensions

Symbol	Dimensions [mm]				Quantity of openings			
	W	H	B	D	Ø5	Ø7	Ø9	Ø11
KP 13	65	170	90	2.5	18	2	2	2

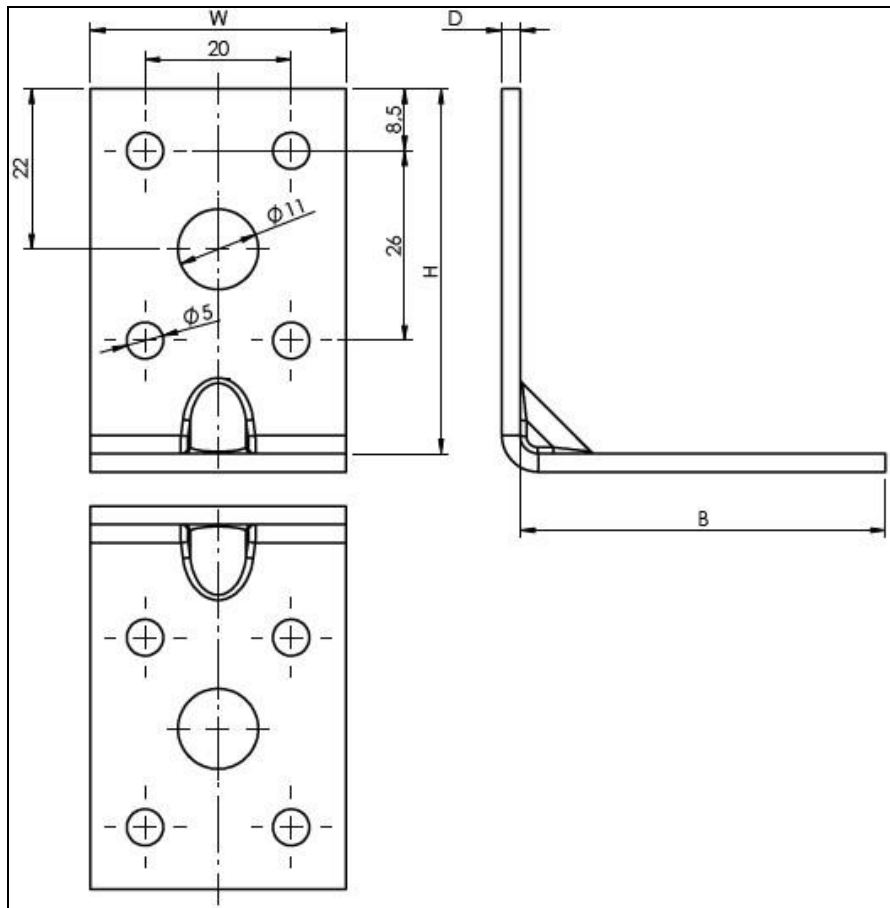

Figure 61 Type KP 15

Table 61 KP three-dimensional nailing plate symbols and dimensions

Symbol	Dimensions [mm]				Quantity of openings	
	W	H	B	D	Ø5	Ø11
KP 15	35	50	50	2.5	8	2

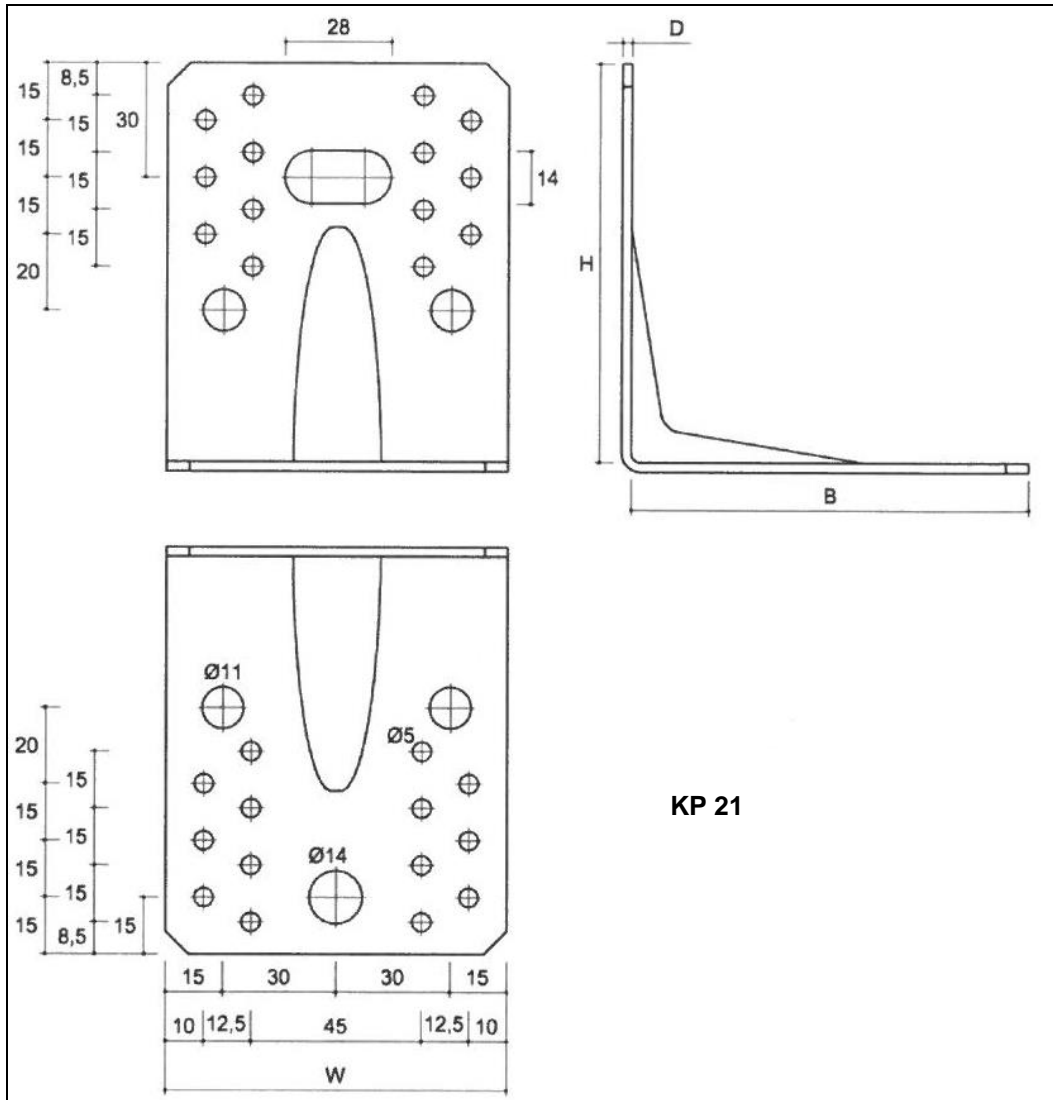

Figure 62 Type KP

Table 62 KP three-dimensional nailing plate symbols and dimensions

Symbol	Dimensions [mm]				Quantity of openings			
	W	H	B	D	Ø 5	Ø 7	Ø 11	Ø 14
KP 21	90	105	105	2,5	28	-	4	1

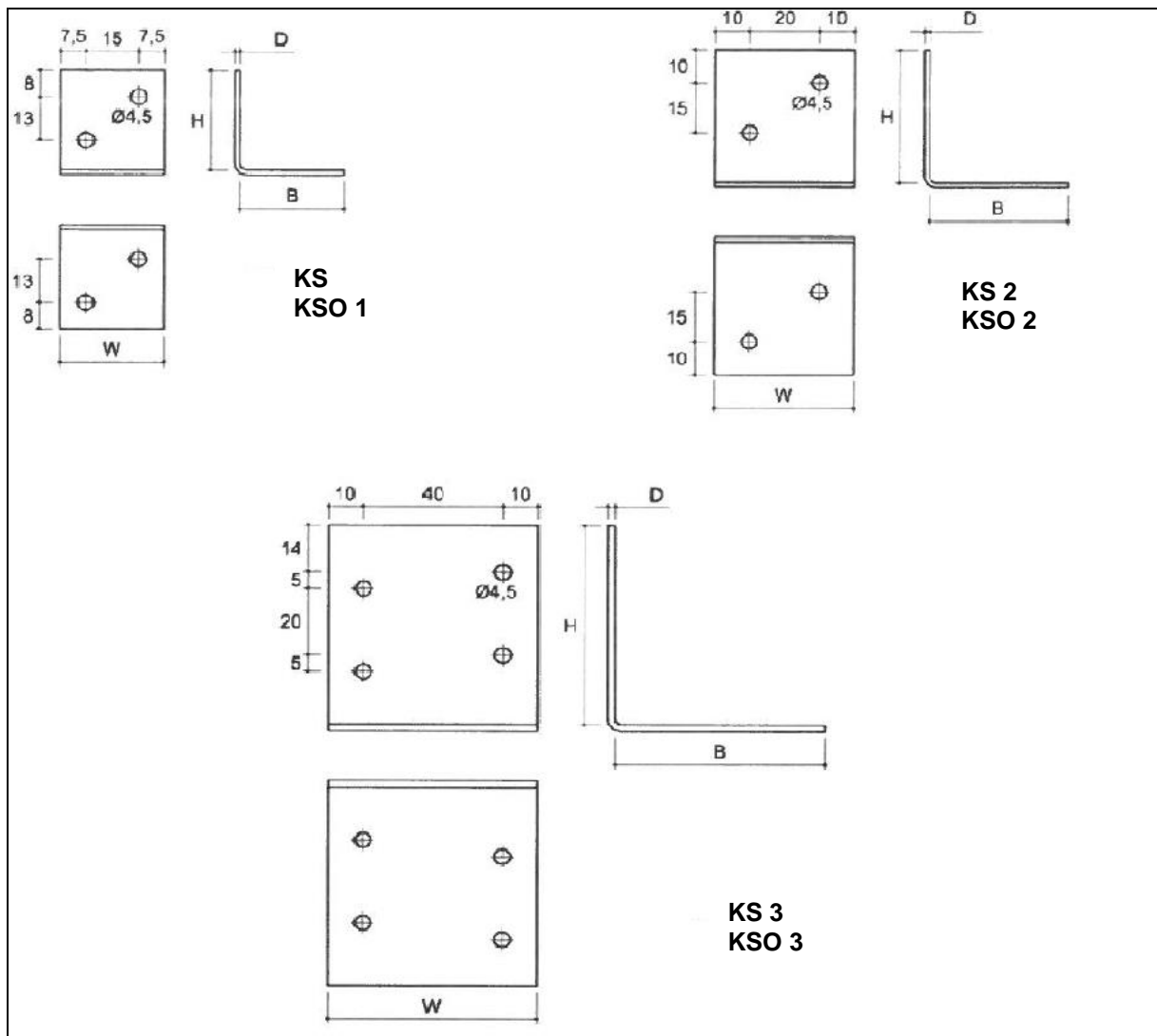

Figure 63 Type KS, KSO

Table 63 KS, KSO three-dimensional nailing plate symbols and dimensions

Symbol	Dimensions [mm]				Quantity of openings
	W	H	B	D	Ø 4.5
KS 1 KSO 1	30	30	30	1.5	4
KS 2 KSO 2	40	40	40	1.5	4
KS 3 KSO 3	60	60	60	2	8

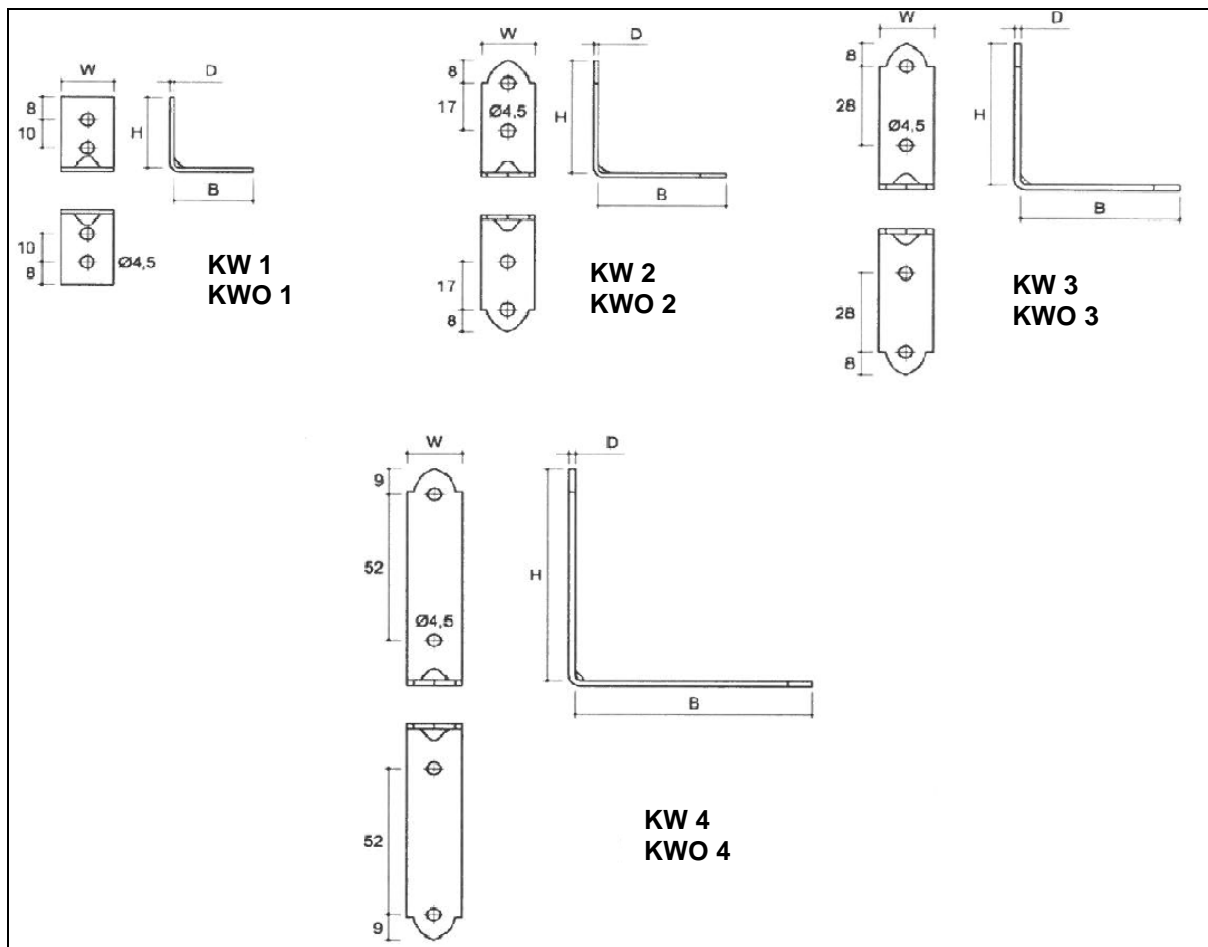

Figure 64 Type KW, KWO

Table 64 KW, KWO three-dimensional nailing plate symbols and dimensions

Symbol	Dimensions [mm]				Quantity of openings Ø 4.5
	W	H	B	D	
KW 1 KWO 1	17	25	25	1.5	4
KW 2 KWO 2	17	40	40	1.5	4
KW 3 KWO 3	17	50	50	2	4
KW 4 KWO 4	17	75	75	2	4

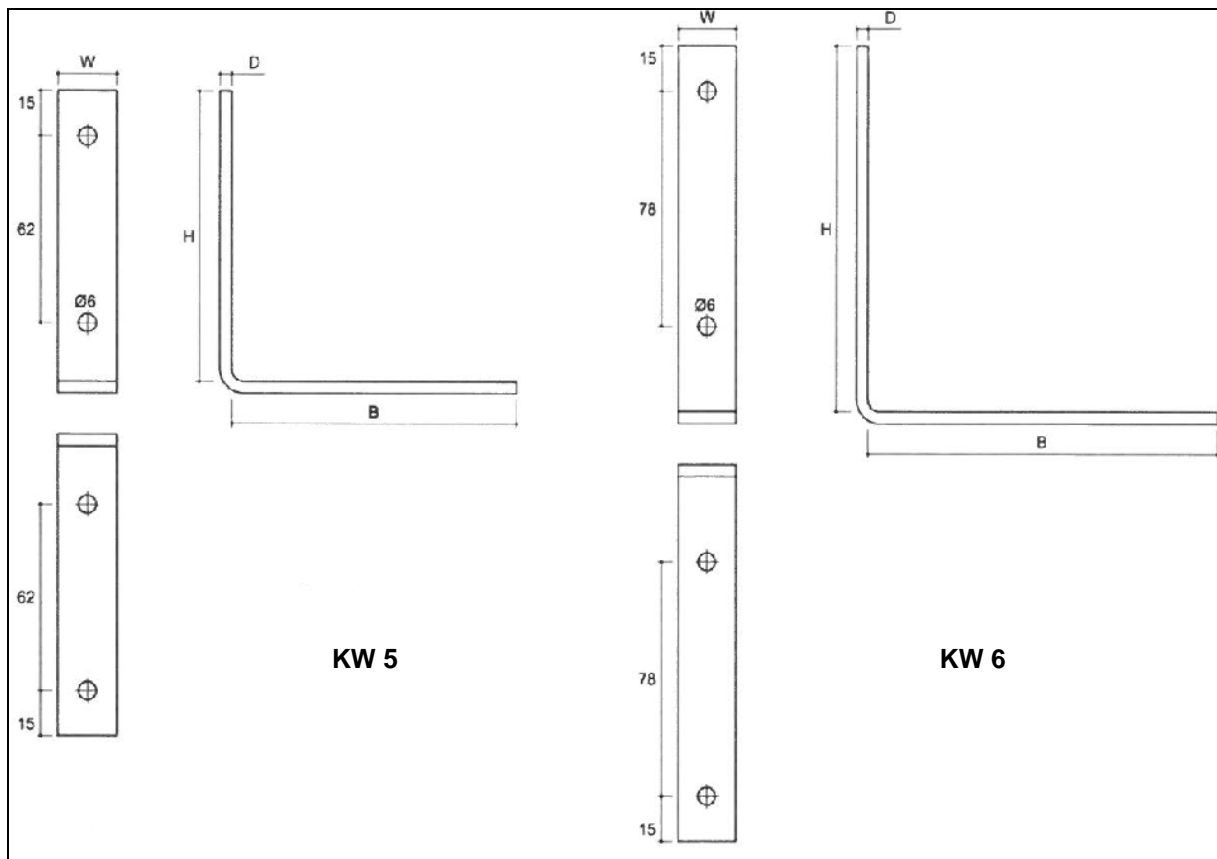

Figure 65 Type KW

Table 65 KW three-dimensional nailing plate symbols and dimensions

Symbol	Dimensions [mm]				Quantity of openings
	W	H	B	D	Ø 6
KW 5	20	96	96	4	4
KW 6	20	121	121	4	4

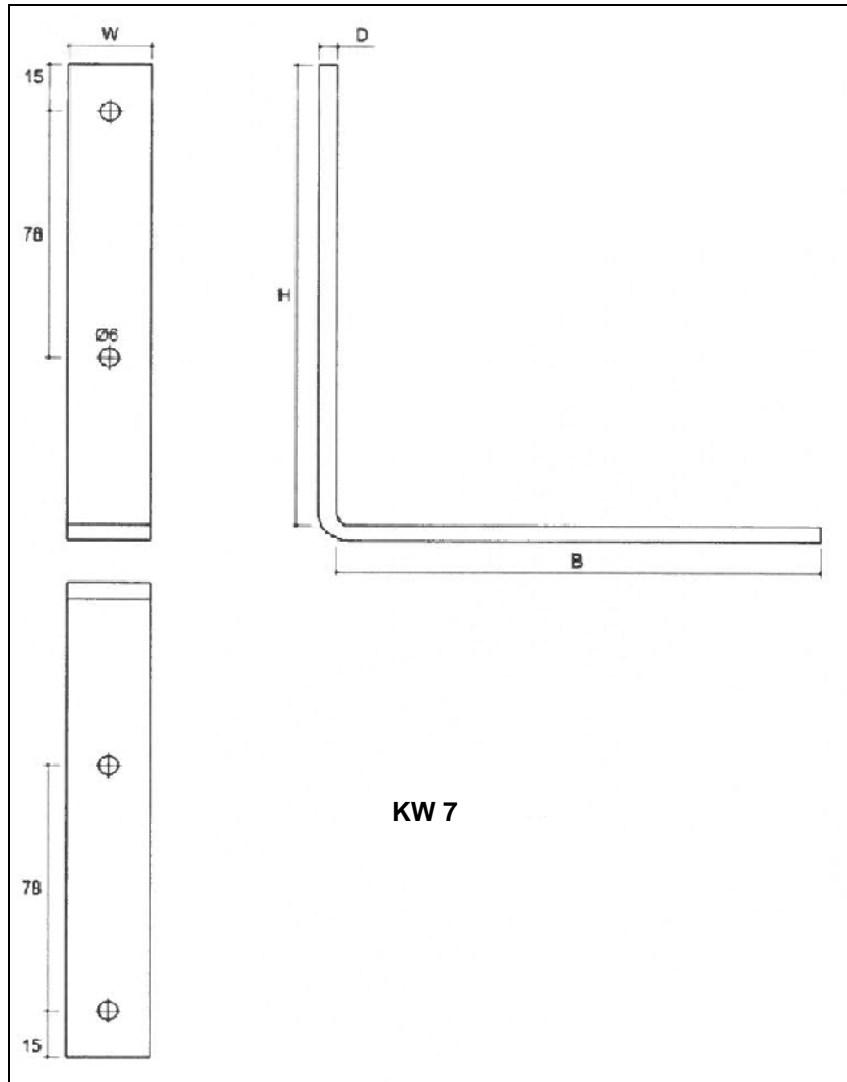

Figure 66 Type KW

Table 66 KW three-dimensional nailing plate symbols and dimensions

Symbol	Dimensions [mm]				Quantity of openings
	W	H	B	D	Ø 6
KW 7	25	146	146	5	4

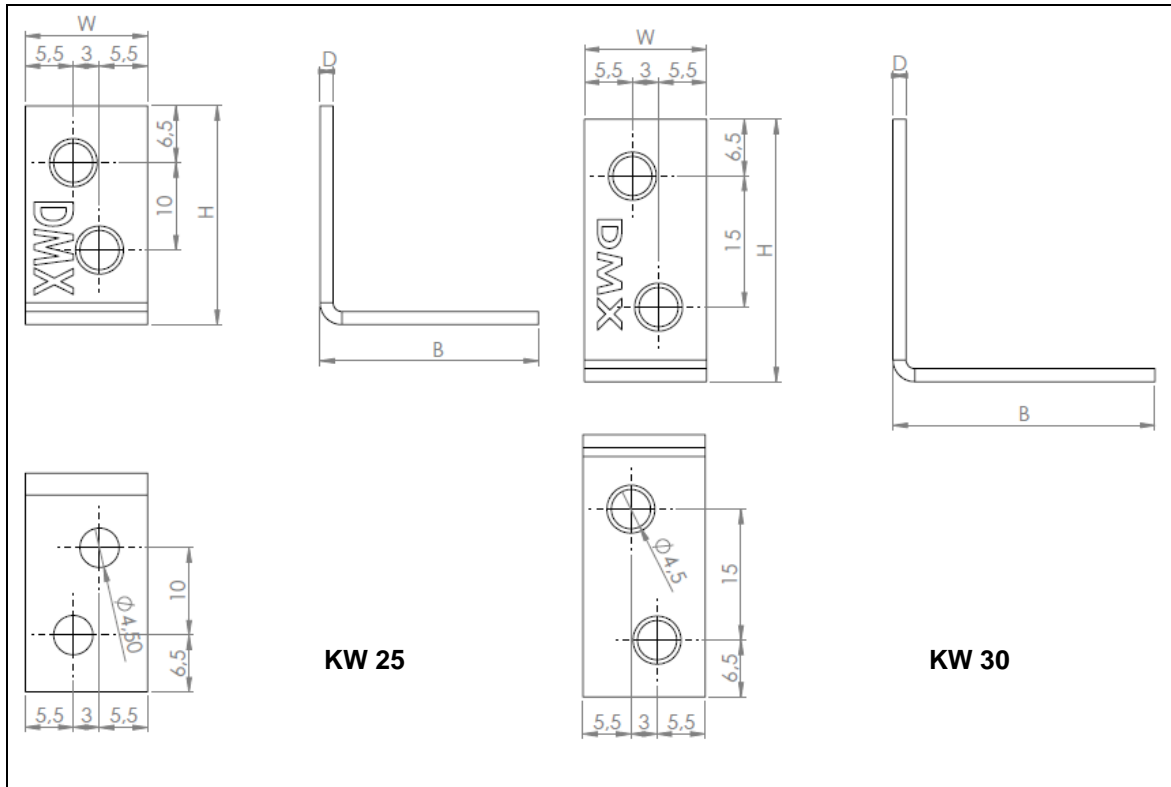

Figure 67 Type KW

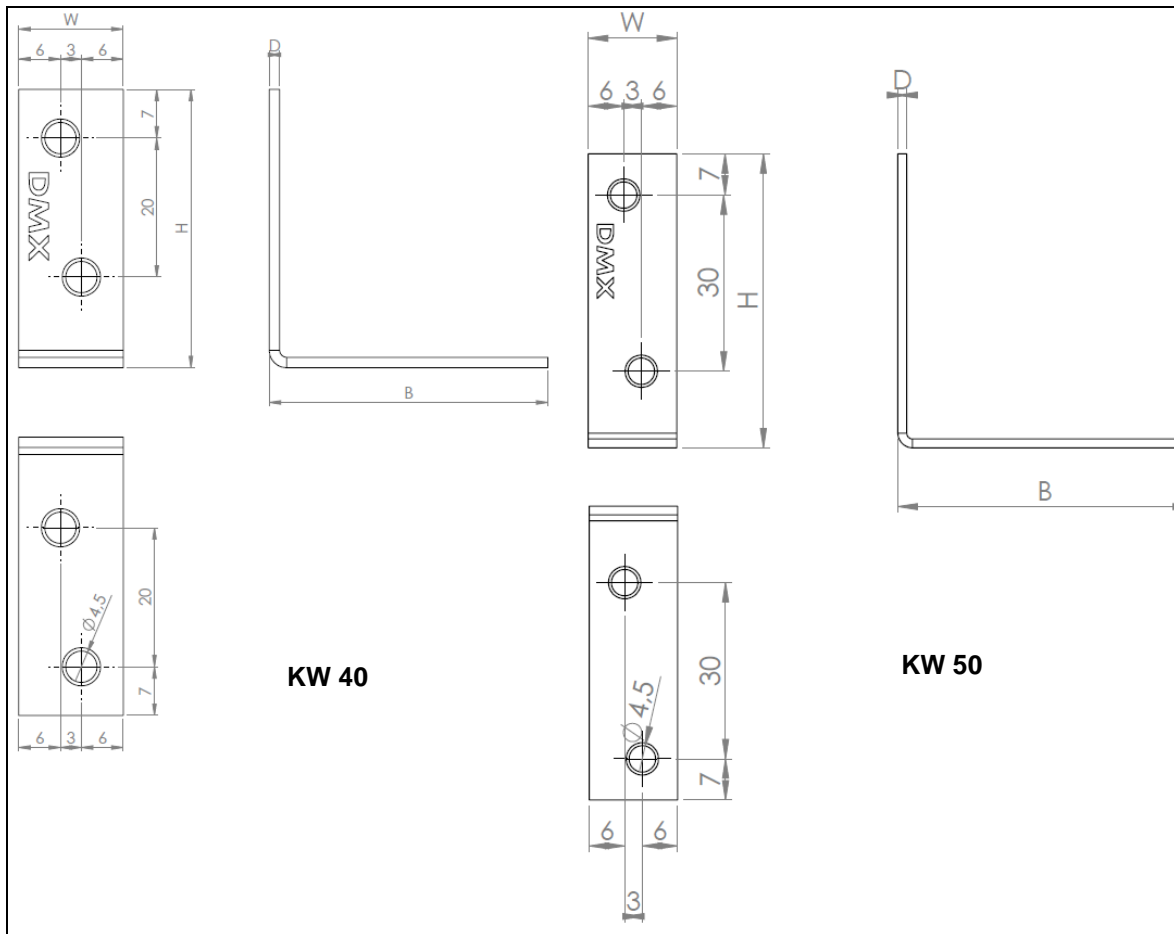

Figure 68 Type KW

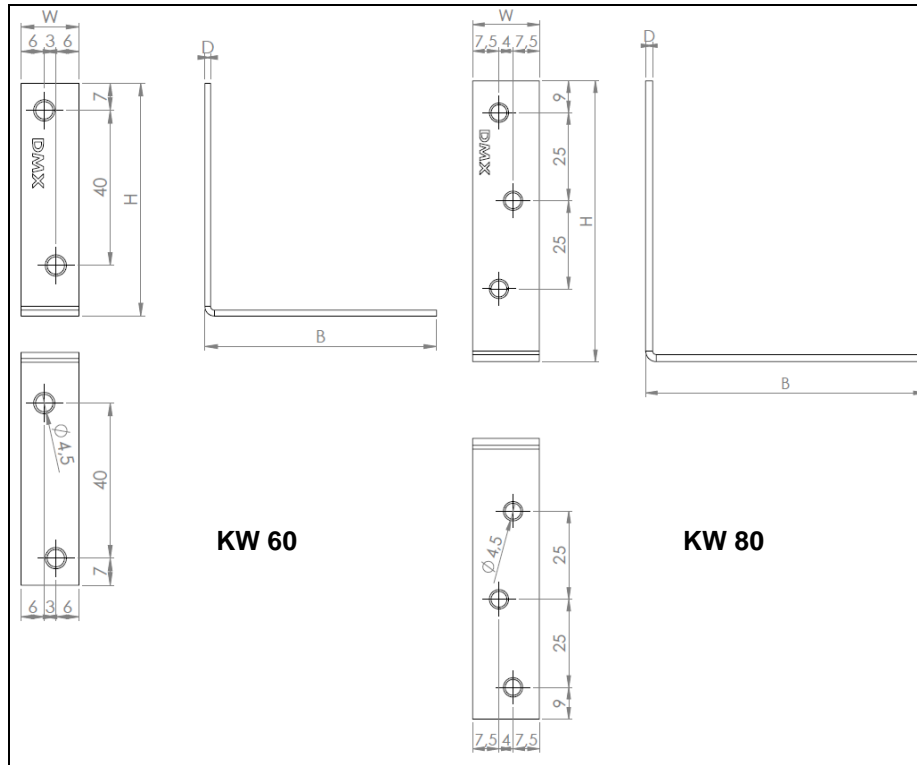

Figure 69 Type KW

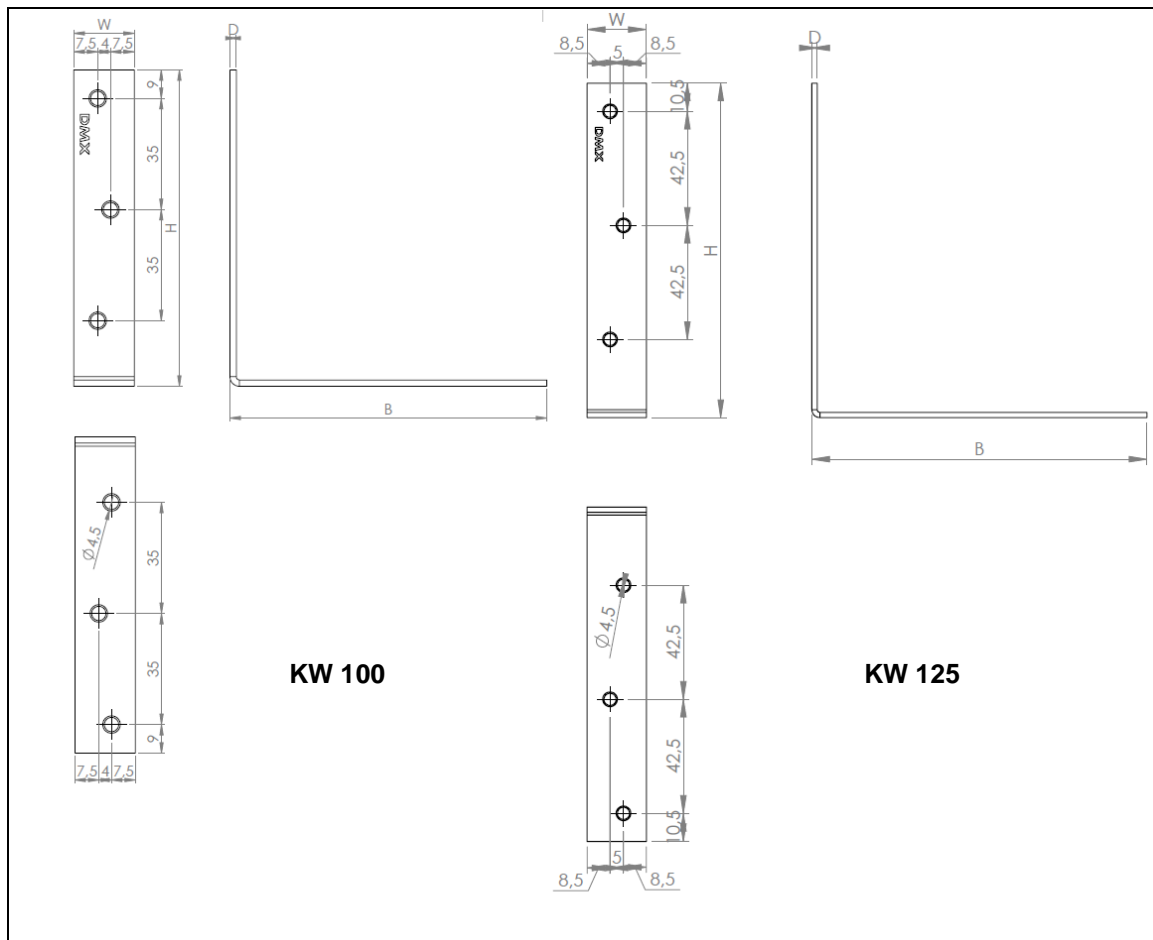

Figure 70 Type KW

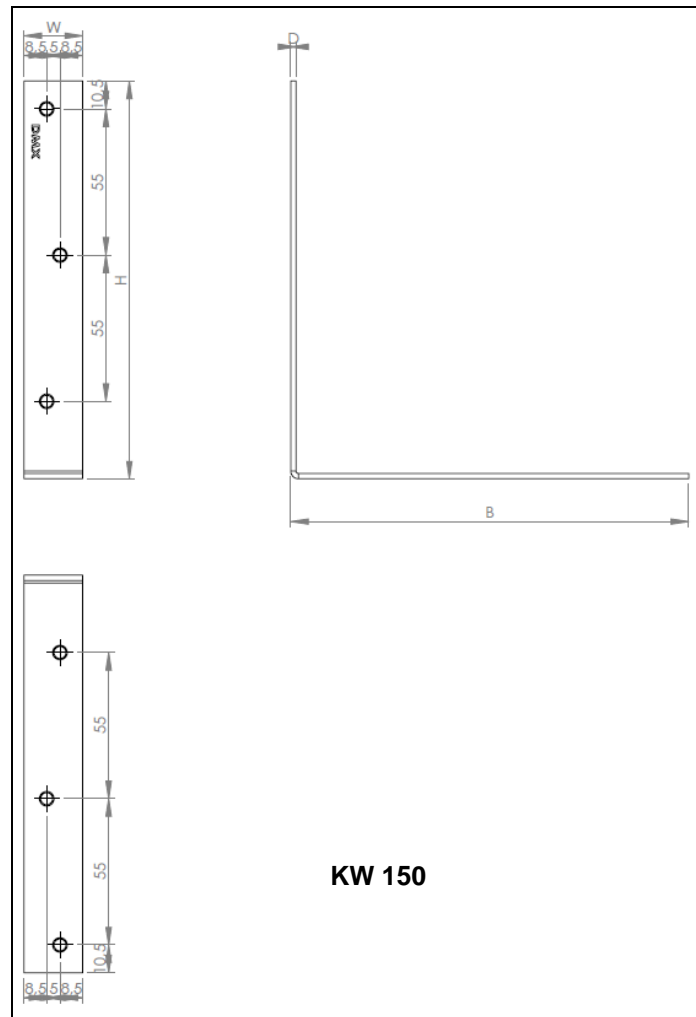

Figure 71 Type KW

Table 67 KW three-dimensional nailing plate symbols and dimensions

Symbol	Dimensions [mm]				Quantity of openings
	W	H	B	D	Ø 4.5
KW 25	14	25	25	1.5	4
KW 30	14	30	30	1.5	4
KW 40	15	40	40	1.5	4
KW 50	15	50	50	1.5	4
KW 60	15	60	60	1.5	4
KW 80	19	80	80	2	6
KW 100	19	100	100	2	6
KW 125	22	125	125	2	6
KW 150	22	150	150	2	6

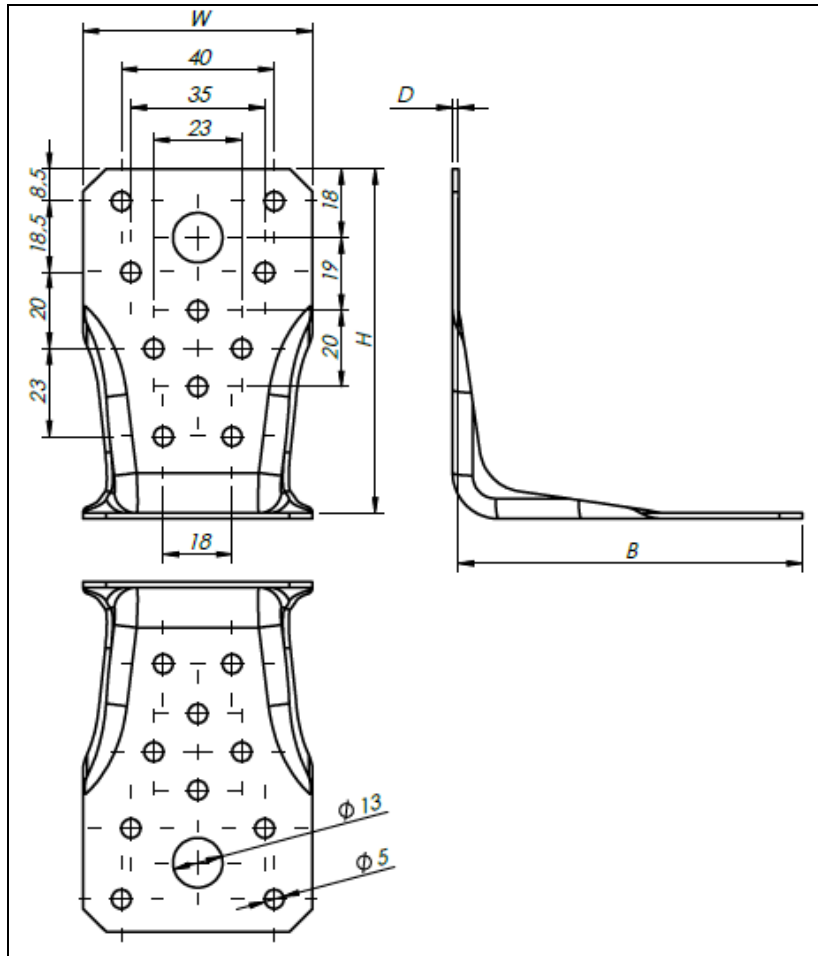

Figure 72 Type LBS

Table 68 LBS three-dimensional nailing plate symbols and dimensions

Symbol	Dimensions [mm]				Quantity of openings	
	W	H	B	D	Ø5	Ø13
LBS 90	60	90	90	1.5	20	2

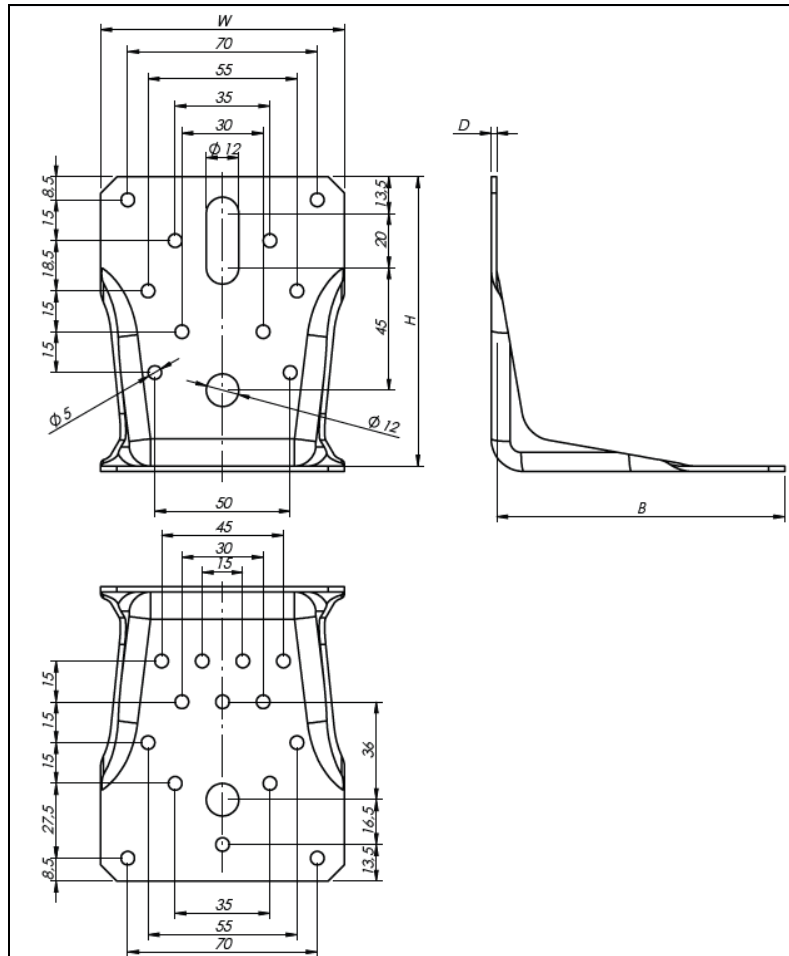
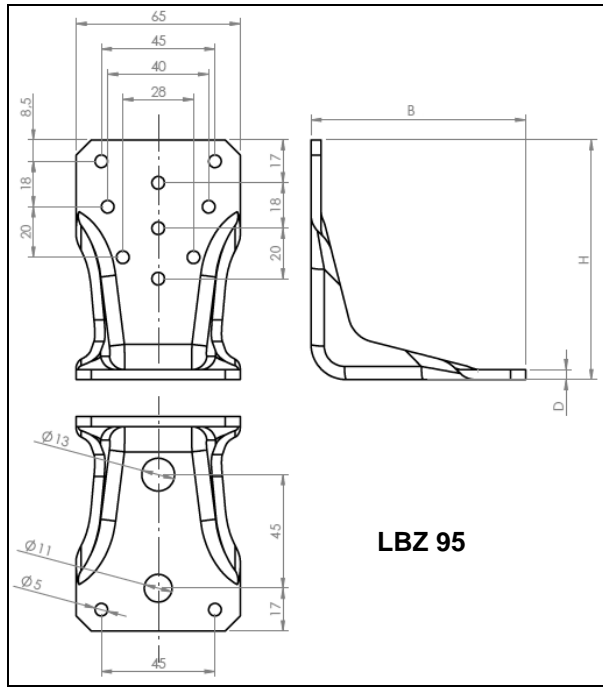

Figure 73 Type LBS

Table 69 LBS three-dimensional nailing plate symbols and dimensions

Symbol	Dimensions [mm]				Quantity of openings	
	W	H	B	D	Ø5	Ø12
LBS 105	90	105	105	2.0	24	2



LBZ 95

Figure 74 Type LBZ

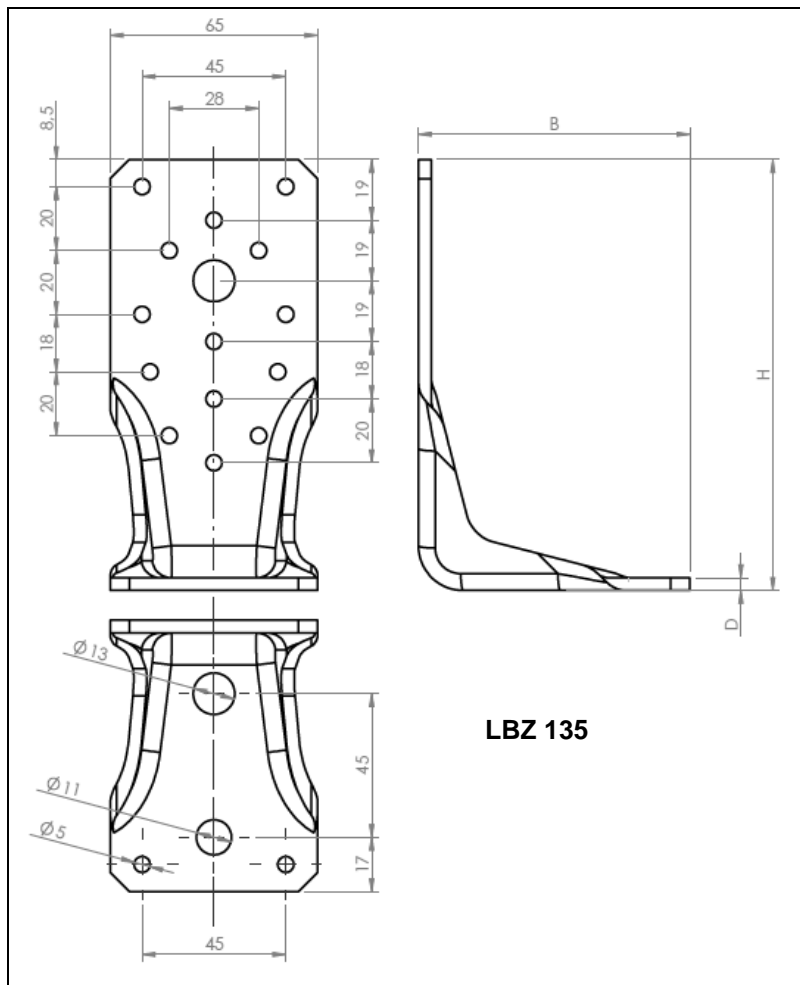

LBZ 135

Figure 75 Type LBZ

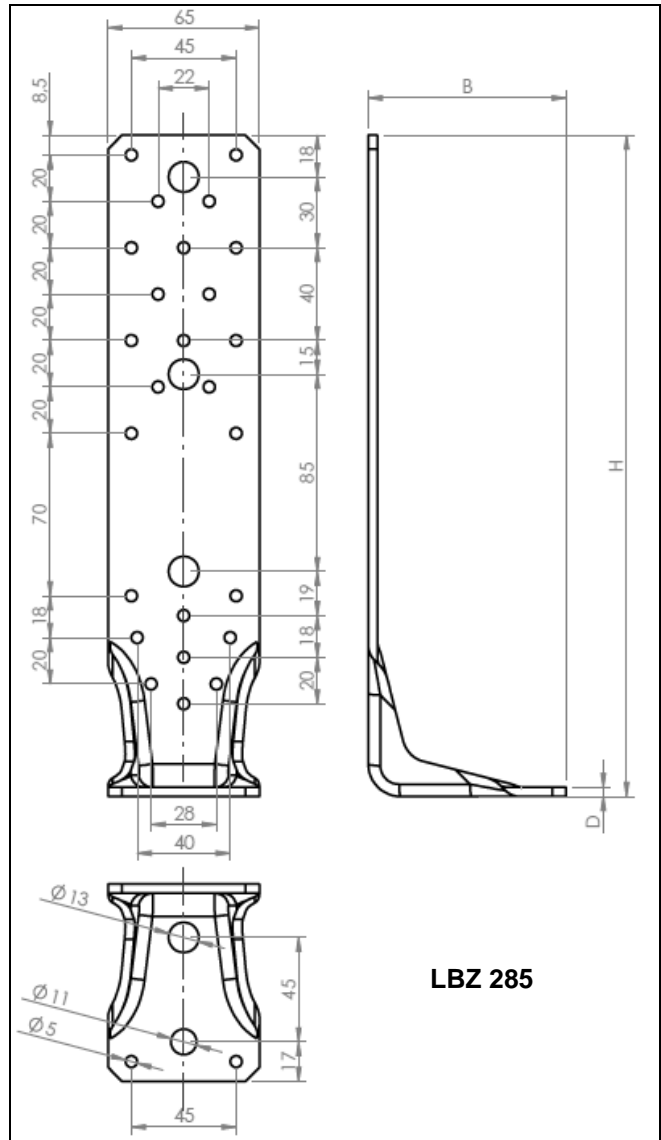

Figure 76 Type LBZ

Table 70 LBZ three-dimensional nailing plate symbols and dimensions

Symbol	Dimensions [mm]				Quantity of openings		
	W	H	B	D	Ø 5	Ø 11	Ø 13
LBZ 95	65	95	85	4	11	1	1
LBZ 135	65	135	85	4	16	1	2
LBZ 285	65	285	85	4	27	1	4

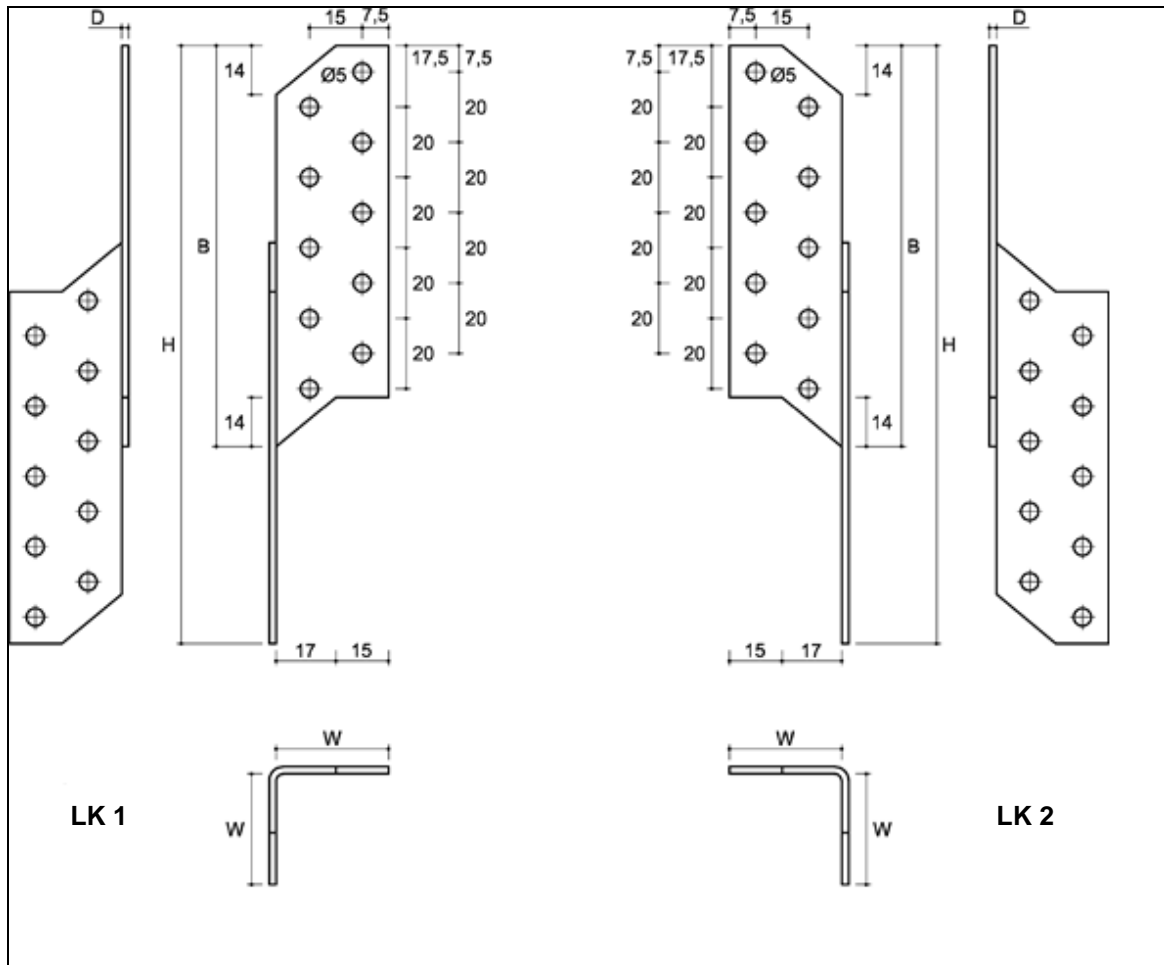

Figure 77 Type LK

Table 71 LK three-dimensional nailing plate symbols and dimensions

Symbol	Dimensions [mm]				Quantity of openings	Type
	W	H	B	D	Ø 5	
LK 1	32	170	114	2	20	left
LK 2	32	170	114	2	20	right

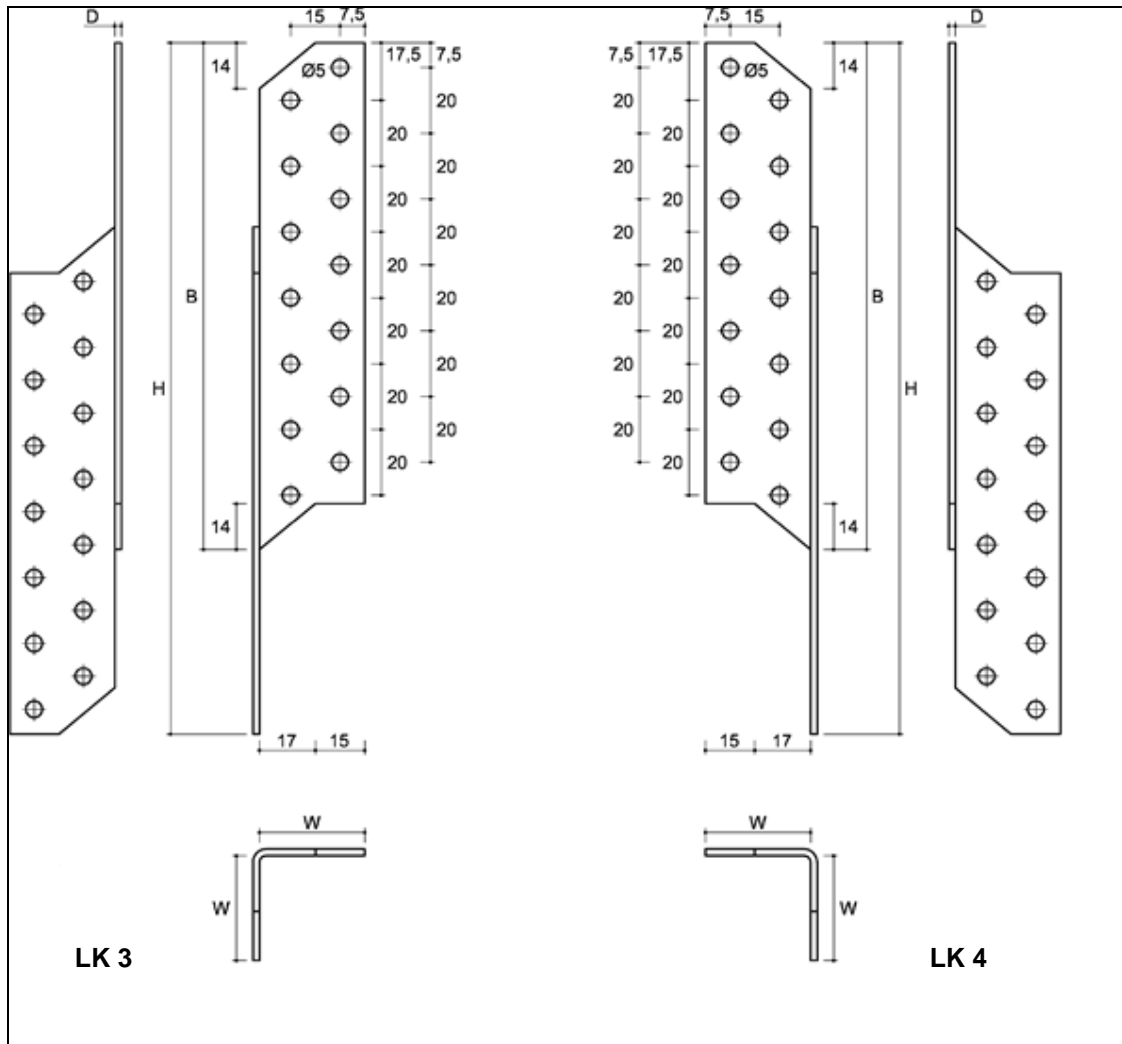

Figure 78 Type LK

Table 72 LK three-dimensional nailing plate symbols and dimensions

Symbol	Dimensions [mm]				Quantity of openings Ø 5	Type
	W	H	B	D		
LK 3	32	210	154	2	28	left
LK 4	32	210	154	2	28	right

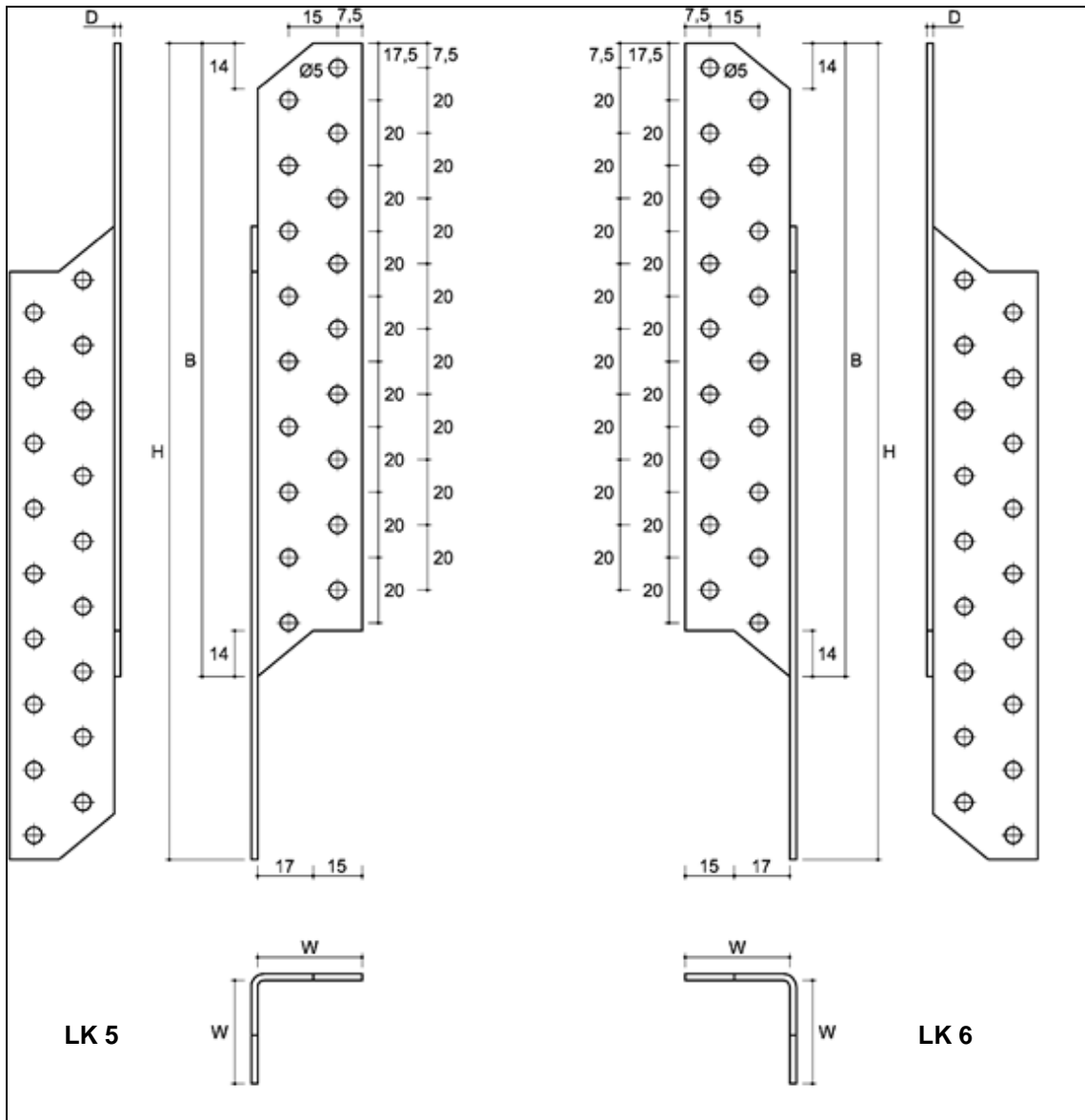

Figure 79 Type LK

Table 73 LK three-dimensional nailing plate symbols and dimensions

Symbol	Dimensions [mm]				Quantity of openings	Type
	W	H	B	D	Ø 5	
LK 5	32	250	194	2	36	left
LK 6	32	250	194	2	36	right

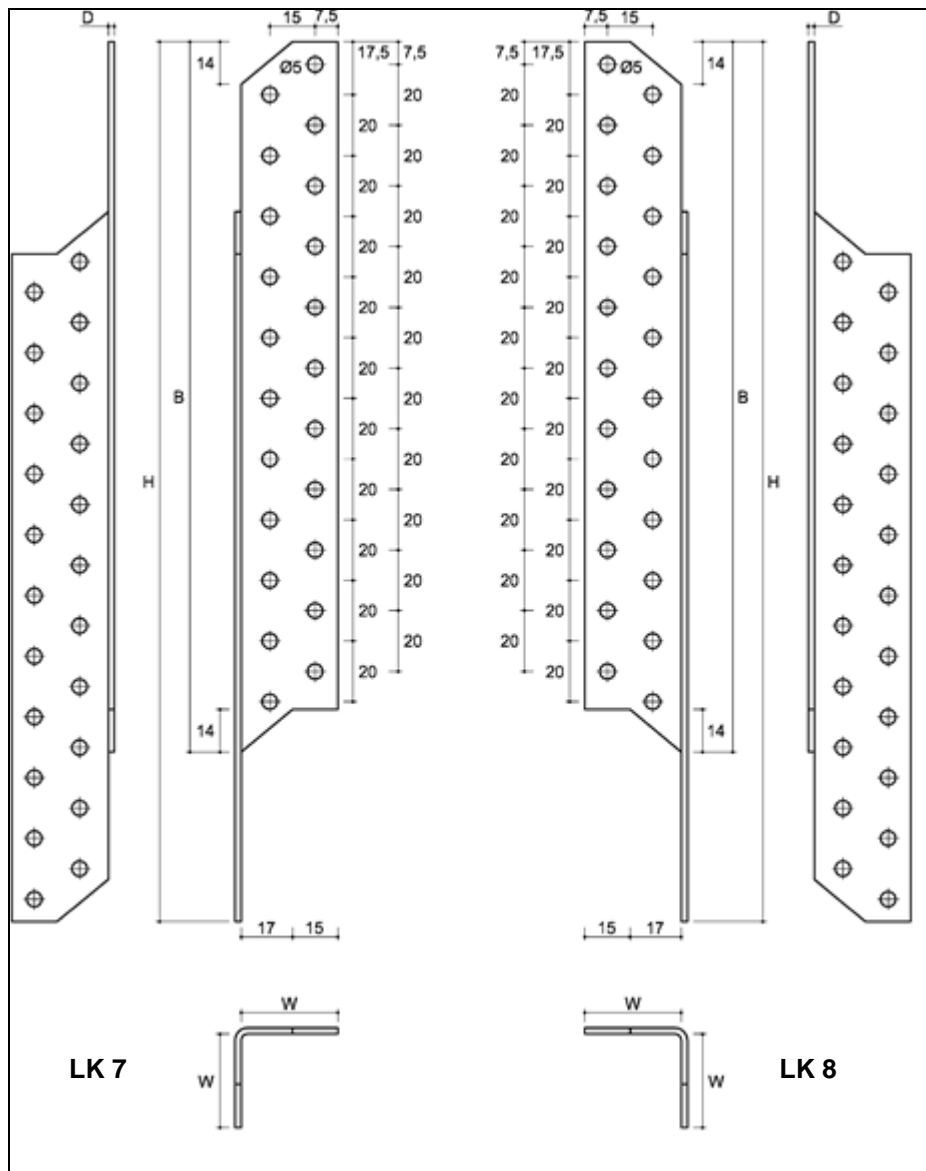
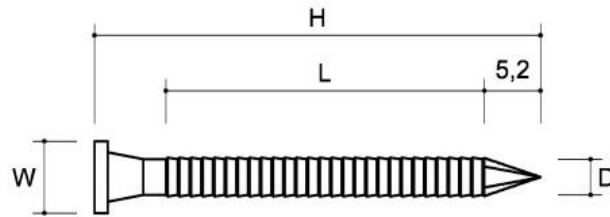

Figure 80 Type LK

Table 74 LK three-dimensional nailing plate symbols and dimensions

Symbol	Dimensions [mm]				Quantity of openings Ø 5	Type
	W	H	B	D		
LK 7	32	290	234	2	44	left
LK 8	32	290	234	2	44	right

Specification of dowel type fasteners



ANG 50

Figure 81 Type ANG 50

Table 75 ANG 50 dimensions

Symbol	Dimensions [mm]				Standard	DoP No.
	D	H	L	W		
ANG 4x50	4	50	36.8	8	EN 14592+A1	DWU 30-20232 AN (issued on 02/01/2018)
ANG 3.1x50	3.1	50	35	6.5	EN 14592+A1	DoP02 (issued on 28.05.2019)

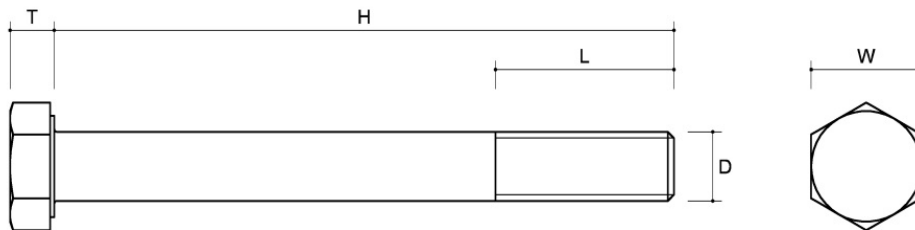

Figure 82 Bolt type M12x35

Table 76 M bolt dimensions

Symbol	Dimensions [mm]					Standard	DoP No.
	D	H	L	W	T		
M12x35	12	35	30	18	7.5	EN 15048-1	NKJ/CPR/20170201 (issued on 01.02.2017)

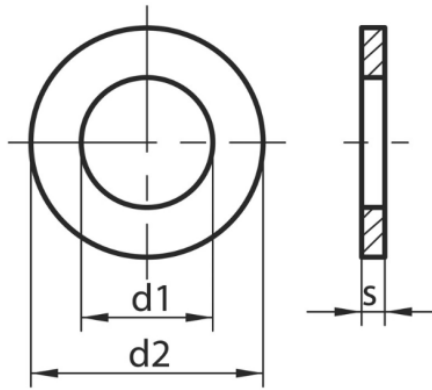

Figure 83 Washer type M12

Table 77 Washer M12 dimensions

Symbol	Dimensions [mm]			Standard	DoP No.
	d ₁	d ₂	s		
M12	13	24	2.5	EN 15048-1	NKJ/CPR/2015-09-01 rev.02 (issued on 15/01/2016)

THREE-DIMENSIONAL NAILING PLATES

LOADING ACCORDING TO STATIC DIAGRAMS

ANNEX 2

ETA 22/0631

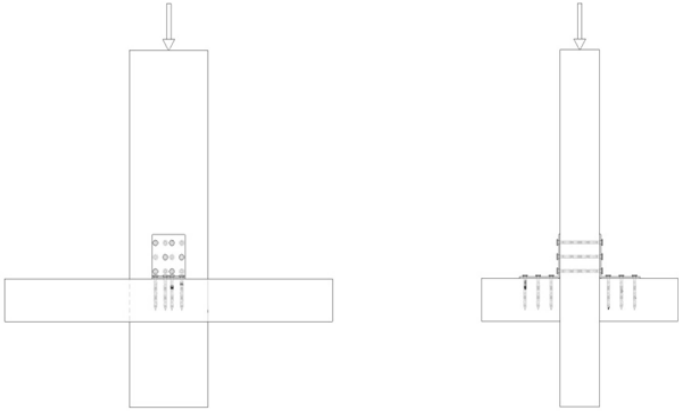
No.	Scheme	Connector types	
1		KG	KW 1
		KRD 1	KW 2
		KRD 2	KW 3
		KRD 3	KW 4
		KRD 4	KW 5
		KMP 1	KW 6
		KMP 2	KW 7
		KMP 3	KW 25
		KMP 4	KW 30
		KMP 5	KW 40
		KMP 6	KW 50
		KMP 7	KW 60
		KMP 8	KW 80
		KMP 9	KW 100
		KMR 1	KW 125
		KMR 2	KW 150
		KMR 3	KK 1
		KMR 4	KK 2
		KMR 5	KK 3
		KMR 6	KM 0
		KMR 7	KM 1
		KMR 8	KM 2
		KMR 9	KM 3
		KMRP 1	KM 4
		KMRP 2	KM 5
		KMRP 3	KM 6
		LZ 1	KM 7
		LZ 2	KM 8
		LZ 3	KM 9
		KS 1	KM 10
		KS 2	KM 11
		KS 3	KM 12
KSO 1	KM 13		
KSO 2	KM 14		
KSO 3	KM 15		
KWO 1	KM 19		
KWO 2	KM 20		
KWO 3	KM 21		
KWO 4	KM 1 (2.5 mm)		
KB 1	KM 2 (2.5 mm)		
KB 2	KM 4 (2.5 mm)		
KB 3	KM 5 (2.5 mm)		

No.	Scheme	Connector types
		KP 1 KM 6 (2.5 mm) KP 2 KM 7 (2.5 mm) KP 3 KM 9 (2.5 mm) KP 4 KM 10 (2.5 mm) KP 5 KM 11 (2.5 mm) KP 6 KM 12 (2.5 mm) KP 10 KM 13 (2.5 mm) KP 11 KM 14 (2.5 mm) KP 12 KM 15 (2.5 mm) KP 13 KM 16 (2.5 mm) KP 14 KM 17 (2.5 mm) KP 15 KM 18 (2.5 mm) KP 21 KM 19 (2.5 mm) KPL 1 KM 20 (2.5 mm) KPL 2 KM 22 (2.5 mm) KPL 3 KL 1 KPL 4 KL 2 KPL 10 KL 3 KPL 12 KL 4 LBS 90 KL 5 LBS 105 KL 101 KL 104 KL 105

Figure 84 Scheme 1

No.	Scheme	Connector types
2		KK 21 KK 22 KK 23 LZB 95 LBZ 135 LBZ 285

Figure 85 Scheme 2

THREE-DIMENSIONAL NAILING PLATES

LOADING ACCORDING TO STATIC DIAGRAMS

ANNEX 2
ETA 22/0631

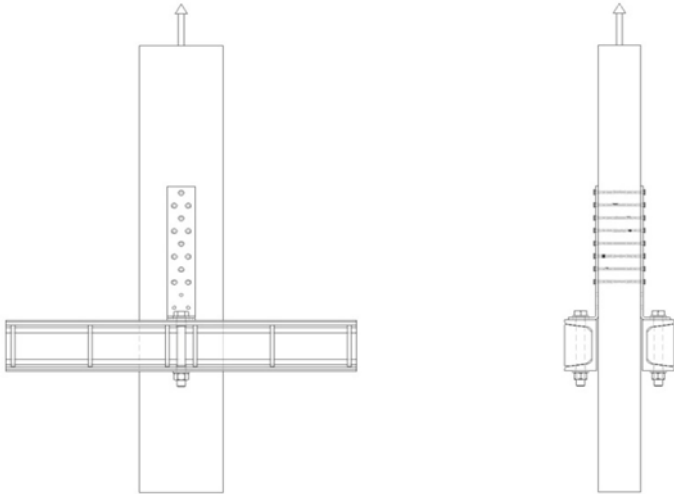
No.	Scheme	Connector type	
3		WB 1	WBZ 20
		WB 2	WBZ 21
		WB 3	WBZ 22
		WB 4	WBZ 23
		WB 5	WBZ 24
		WB 6	WBZ 25
		WB 7	WBZ 26
		WB 8	WBZ 27
		WB 9	WBZ 28
		WB 10	WBZ 29
		WB 11	WBZ 30
		WB 12	WBZ 31
		WB 13	WBZ 32
		WB 14	WBZ 33
		WB 15	WBZ 34
		WB 16	WBZ 35
		WB 17	WBZ 36
		WB 18	WBZ 37
		WB 19	WBD 105L
		WB 20	WBD 105P
		WB 21	WBD 130L
		WB 22	WBD130P
		WB 23	WBD 140L
		WB 24	WBD 140P
		WB 25	WBD 170L
		WB 26	WBD 170P
		WB 27	WBD 200L
		WB 28	WBD 200P
		WB 29	WL 5
		WB 30	WL 6
		WB 31	WL 7
		WB 32	WL 8
		WB 33	WL 9
		WB 34	
		WB 35	
		WB 36	
		WB 37	
		WB 38	
		WB 64	

Figure 86 Scheme 3

No.	Scheme	Connector type
4		LK 1 LK 2 LK 3 LK 4 LK 5 LK 6 LK 7 LK 8

Figure 87 Scheme 4

No.	Scheme	Connector type
5		LZ 0

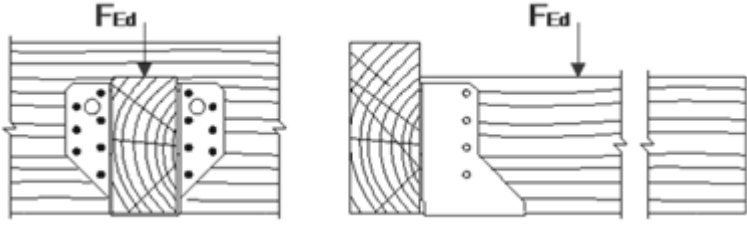
Figure 88 Scheme 5

THREE-DIMENSIONAL NAILING PLATES	ANNEX 3 ETA 22/0631
THE LOAD-CARRYING CAPACITIES OF CONNECTORS	

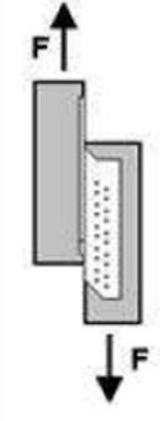
Table 78 The load-carrying capacities of connectors

Connector	Type of Load	Timber Moisture [%]	Density	$P_{max,mean}$	$P_{max,k}$	Connectors per connection	Method of determination	Document No.	Note
			$\rho_{mean, 12\%}$	(350 kg·m ³)	(350 kg·m ³)				
			[kg·m ³]	[kN]	[kN]				
WB 1	pressure	11±1	350	19.1 ³ /23.35	17.05 ³ /19.0	1	testing	LOK-672/C/06	1)
WB 2				19.1 ³ /23.35	17.05 ³ /19.0				
WB 3				27.7	20.3				
WB 4				29.6	25.45				
WB 5				19.1 ³ /23.35	17.05 ³ /19.0				
WB 6				27.7	20.3				
WB 7				29.6	25.45				
WB 8				19.1 ³ /23.35	17.05 ³ /19.0				
WB 9				27.7	20.3				
WB 10				19.1 ³ /23.35	17.05 ³ /19.0				
WB 11				27.7	20.3				
WB 12				29.6	25.45				
WB 13				32.2	27.75				
WB 14				19.1 ³ /23.35	17.05 ³ /19.0				
WB 15				27.7	20.3				
WB 16				29.6	25.45				
WB 17				32.2	27.75				
WB 18				34.9	32.3				
WB 19				19.1 ³ /23.35	17.05 ³ /19.0				
WB 20				27.7	20.3				

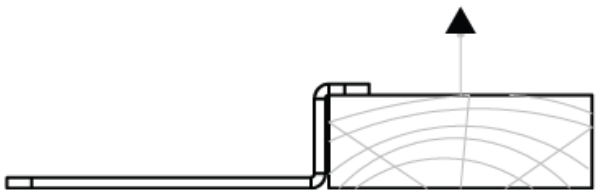
Connector	Type of Load	Timber Moisture [%]	Density	$P_{max,mean}$	$P_{max,k}$	Connectors per connection	Method of determination	Document No.	Note
			$\rho_{mean, 12\%}$	(350 kg·m ³)	(350 kg·m ³)				
			[kg·m ³]	[kN]	[kN]				
WB 21				27.7	20.3				
WB 22				29.6	25.45				
WB 23				27.7	20.3				
WB 24				29.6	25.45				
WB 25				32.2	27.75				
WB 26				27.7	20.3				
WB 27				29.6	25.45				
WB 28				32.2	27.75				
WB 29				34.9	32.3				
WB 30				29.6	25.45				
WB 31				32.2	27.75				
WB 32				34.9	32.3				
WB 33				32.2	27.75				
WB 34				34.9	32.3				
WB 35				32.2	27.75				
WB 36				34.9	32.3				
WB 37				34.9	32.3				
WB 38				34.9	32.3				
WB 64	-	C24	-	14.7	calculation	WB64-O-01/22			
WBZ 20	pressure	13.8	401	32.8	26.5	1	testing	WBZ-R-01/23	1)
WBZ 21		11±1	350	18.45 ³ /22.40	12.75 ³ /17.15			LOK-672/C/06	
WBZ 22				33.35 ³ /34.15	22.35 ³ /23.65				
WBZ 23				18.45 ³ /22.40	12.75 ³ /17.15				
WBZ 24				33.35 ³ /34.15	22.35 ³ /23.65				
WBZ 25	37.5			30.95					

Connector	Type of Load	Timber Moisture [%]	Density	$P_{max,mean}$	$P_{max,k}$	Connectors per connection	Method of determination	Document No.	Note
			$\rho_{mean, 12\%}$	(350 kg·m ³)	(350 kg·m ³)				
			[kg·m ³]	[kN]	[kN]				
WBZ 26				18.45 ³ /22.40	12.75 ³ /17.15				
WBZ 27				33.35 ³ /34.15	22.35 ³ /23.65				
WBZ 28				37.5	30.95				
WBZ 29				31.25	28.65				
WBZ 30				33.35 ³ /34.15	22.35 ³ /23.65				
WBZ 31				37.5	30.95				
WBZ 32				31.25	28.65				
WBZ 33				37.5	30.95				
WBZ 34				31.25	28.65				
WBZ 35				37.5	30.95				
WBZ 36				31.25	28.65				
WBZ 37				31.25	28.65				
WBD 105L				pressure	-				
WBD 105P									
WBD 130L									
WBD130P									
WBD 140L									
WBD 140P									
WBD 170L									
WBD 170P									
WBD 200L									
WBD 200P									
LK 1	pressure	-	C24	21.26	19.36	2	testing	LOK-1289/A/09	2)
LK 2				22.16	19.25				
LK 3									

Connector	Type of Load	Timber Moisture [%]	Density	$P_{max,mean}$	$P_{max,k}$	Connectors per connection	Method of determination	Document No.	Note
			$\rho_{mean, 12\%}$	(350 kg·m ³)	(350 kg·m ³)				
			[kg·m ³]	[kN]	[kN]				
LK 4									
LK 5									
LK 6									
LK 7									
LK 8									
KG	pressure	12.7	421	19.5	14.6	2	testing	KG-R-01/22	2)
WL 5	pressure	-	C24	15.5	14.29	1	testing	LOK-1289/A/09	1)
WL 6									
WL 7									
WL 8									
WL 9									
KRD 1	pressure	13.0	413	11.1	7.4	2	testing	KRD-R-01/22	2)
KRD 2		12.9	416	12.2	9.5				
KRD 3		12.8	409	13.1	10.8				
KRD 4									
KMP 1	pressure	-	C24	6.85	6.2	2	testing	LOK-1289/A/09	2)
KMP 2				6.71	5.91				
KMP 3				6.92	6.26				
KMP 4				3.82	3.41				
KMP 5				6.02	5.51				
KMP 6				7.11	6.8				
KMP 7				6.12	5.53				
KMP 8				7.42	6.57				
KMP 9				12.1	10.71				
KMR 1	pressure	-	C24	6.2	5.52	2	testing	LOK-1289/A/09	2)

Connector	Type of Load	Timber Moisture [%]	Density	$P_{max,mean}$	$P_{max,k}$	Connectors per connection	Method of determination	Document No.	Note
			$\rho_{mean, 12\%}$	(350 kg·m ³)	(350 kg·m ³)				
			[kg·m ³]	[kN]	[kN]				
KMR 2									
KMR 3									
KMR 4									
KMR 5									
KMR 6									
KMR 7									
KMR 8									
KMR 9									
KMRP 1									
KMRP 2	8.33	6.9							
KMRP 3	8.08	7.4							
LZ 0	pull out	-	C24	-	1.3	1	calculation	LZ0-O-01/22	1)
LZ 1	pressure	-	C24	4.02	3.62	2	testing	LOK-1289/A/09	2)
LZ 2									
LZ 3									
KS 1	pressure	-	C24	3.68	3.44	2	testing	LOK-1289/A/09	2)
KS 2				7.04	6.65				
KS 3									
KSO 1	pressure	-	C24	3.95	3.49	2	testing	LOK-1289/A/09	2)
KSO 2				7.28	6.58				
KSO 3									
KWO 1	pressure	-	C24	2.9	2.51	2	testing	LOK-1289/A/09	2)
KWO 2									
KWO 3									
KWO 4									

Connector	Type of Load	Timber Moisture [%]	Density	$P_{max,mean}$	$P_{max,k}$	Connectors per connection	Method of determination	Document No.	Note
			$\rho_{mean, 12\%}$	(350 kg·m ³)	(350 kg·m ³)				
			[kg·m ³]	[kN]	[kN]				
KB 1	pressure	-	C24	7.84	7.46	2	testing	LOK-1289/A/09	2)
KB 2				9.04	8.62				
KB 3									
KP 1	pressure	12.5	413	32.6	27.2	2	testing	KP-R-01/22 KP-R-01/23	2)
KP 2		12.7	404	40.5	35.2				
KP 3		12.9	403	29.5	23.1				
KP 4		12.7	414	23.7	19.6				
KP 5		12.9	424	35.7	25.7				
KP 6		12.8	407	43.3	34.6				
KP 10		12.6	405	43.5	38.4				
KP 11		12.6	405	28.5	23.1				
KP 12		12.7	410	38.3	33.8				
KP 13		12.9	405	37.4	32.5				
KP 14		12.9	405	38.8	31.1				
KP 15		12.7	412	18.7	16.5				
KP 21		12.6	403	38.3	31				
KPL 1	pressure	12.7	401	28.2	22.3	2	testing	KPL-R-01/22 KPL-R-01/23	2)
KPL 2		12.5	409	38.4	28.4				
KPL 3		12.7	424	23.9	20.5				
KPL 4		12.8	405	21.2	18.5				
KPL 10		12.8	411	37.5	31.8				
KPL 12		12.8	400	31.8	27.9				
KL 1	pressure	12.7	410	14	11	2	testing	KL-R-01/22 KL-R-01/23	2)
KL 2		12.8	401	24.4	20.2				
KL 3		12.7	406	17.7	15.2				
KL 4		13	401	24.8	21.9				

Connector	Type of Load	Timber Moisture	Density	$P_{max,mean}$	$P_{max,k}$	Connectors per connection	Method of determination	Document No.	Note
			$\rho_{mean, 12\%}$	(350 kg·m ³)	(350 kg·m ³)				
			[%]	[kg·m ³]	[kN]				
KL 5		12.9	405	31.2	27.6				
KL 101		12.8	414	14.2	10.2				
KL 104		12.7	406	24.9	18.8				
KL 105		12.6	402	28.3	21.9				
KW 1	pressure	12.8	413	7.2	6	2	testing	KW-R-01/22	2)
KW 2									
KW 3		12.9	402	7.3	5.5				
KW 4									
KW 5									
KW 6		12.7	409	12.6	10.9				
KW 7									
KW 25		12.7	430	14.7	11.1				
KW 30									
KW 40									
KW 50									
KW 60		12.6	407	7.6	5.6				
KW 80									
KW 100									
KW 125									
KW 150									
KW 80	12.9	410	9.7	7.6					
KW 100									
KK 1	pressure	12.9	400	14.4	11.6	2	testing	KK-R-01/22	2
KK 2		12.7	405	16.6	13.1				
KK 3		12.8	400	16.6	14.7				
KK 21	pull out	12.9	405	25.5	19.9			KK-R-02/22	
KK 22		12.8	420	27.4	22.5				

Connector	Type of Load	Timber Moisture [%]	Density	$P_{max,mean}$	$P_{max,k}$	Connectors per connection	Method of determination	Document No.	Note
			$\rho_{mean, 12\%}$	(350 kg·m ³)	(350 kg·m ³)				
			[kg·m ³]	[kN]	[kN]				
KK 23		12.8	420	29.3	25.9				
KM 0	pressure	12.7	411	8.8	7.2	2	testing	KM-R-01/23	2)
KM 1		-	C24	-	14		calculation	KM-O-01/22	
KM 2		-	C24	-	14				
KM 3		12.8	410	16.1	14		testing	KM-R-01/22	
KM 4		-	C24	-	15.2				
KM 5		-	C24	-	19.88		calculation	KM-O-01/22	
KM 6		12.7	403	31.6	26.3		testing	KM-R-01/22	
KM 7		-	C24	-	14.8		calculation	KM-O-01/22	
KM 8		12.8	413	19.2	15.6		testing	KM-R-01/22	
KM 9		-	C24	-	26.83		calculation	KM-O-01/22	
KM 10		12.8	413	32.9	27.9		testing	KM-R-01/22	
KM 11		-	C24	-	19.88				
KM 12		-	C24	-	28.54		calculation	KM-O-01/22	
KM 13		12.6	410	33.4	29.5		testing	KM-R-01/22	
KM 14		-	C24	-	14.8				
KM 15		-	C24	-	24.16		calculation	KM-O-01/22	
KM 19		-	C	-	15.2				
KM 20		-	C24	-	13.6				
KM 21	12.5	400	17.3	15.1	testing	KM-R-01/23			
KM 1 (2.5 mm)	pressure	-	C24	-	15	2	calculation	KM2,5-O-01/22	2)
KM 2 (2.5 mm)		12.6	411	17.2	15		testing	KM2,5-R-01/22	
KM 4 (2.5 mm)		-	C24	-	17.8				
KM 5 (2.5 mm)		-	C24	-	22.9		calculation	KM2,5-O-01/22	
KM 6 (2.5 mm)		12.7	411	34.4	28				
KM 7 (2.5 mm)		12.8	408	19.2	16.1		testing	KM2,5-R-01/22	

Connector	Type of Load	Timber Moisture [%]	Density	$P_{max,mean}$	$P_{max,k}$	Connectors per connection	Method of determination	Document No.	Note
			$\rho_{mean, 12\%}$	(350 kg·m ³)	(350 kg·m ³)				
			[kg·m ³]	[kN]	[kN]				
KM 9 (2.5 mm)		-	C24	-	28.53		calculation	KM2,5-O-01/22	
KM 10 (2.5 mm)		12.9	411	33.9	29.6		testing	KM2,5-R-01/22	
KM 11 (2.5 mm)		-	C24	-	22.9		calculation	KM2,5-O-01/22	
KM 12 (2.5 mm)		-	C24	-	30.68		testing	KM2,5-R-01/22	
KM 13 (2.5 mm)		12.9	410	37.6	32.3				
KM 14 (2.5 mm)		-	C24	-	16.1		calculation	KM2,5-O-01/22	
KM 15 (2.5 mm)		-	C24	-	26.3				
KM 16 (2.5 mm)		-	C24	-	16.1				
KM 17 (2.5 mm)		-	C24	-	15				
KM 18 (2.5 mm)		-	C24	-	16.1				
KM 19 (2.5 mm)		-	C24	-	17.8				
KM 20 (2.5 mm)		-	C24	-	14.45				
KM 22 (2.5 mm)		12.7	406	23.7	20.9				
LBS 90	pressure	12.8	413	20.7	18.3	2	testing	LBS-R-01/23	2)
LBS 105		12.6	404	30.4	26.3				
LBZ 95	pull out	13	407	21.7	18.4	2	testing	LBZ-R-01/22	2)
LBZ 135		13	432	37	29.2				
LBZ 285		-	C24	-	50.6		calculation	LBZ-O-01/22	

1) The forces are given for the complete connection consisting of one connector.

2) The forces are given for the complete connection consisting of two connectors, hence force per one connector (one angle bracket) is half of the given value.

3) Partial nailing acc. to DMX-G-01/22

It is always necessary to put nails in the black marked holes. This is the only one proper pattern. Too many or too long nails can weaken the wood, when are quite close to edge (rule is stated below).

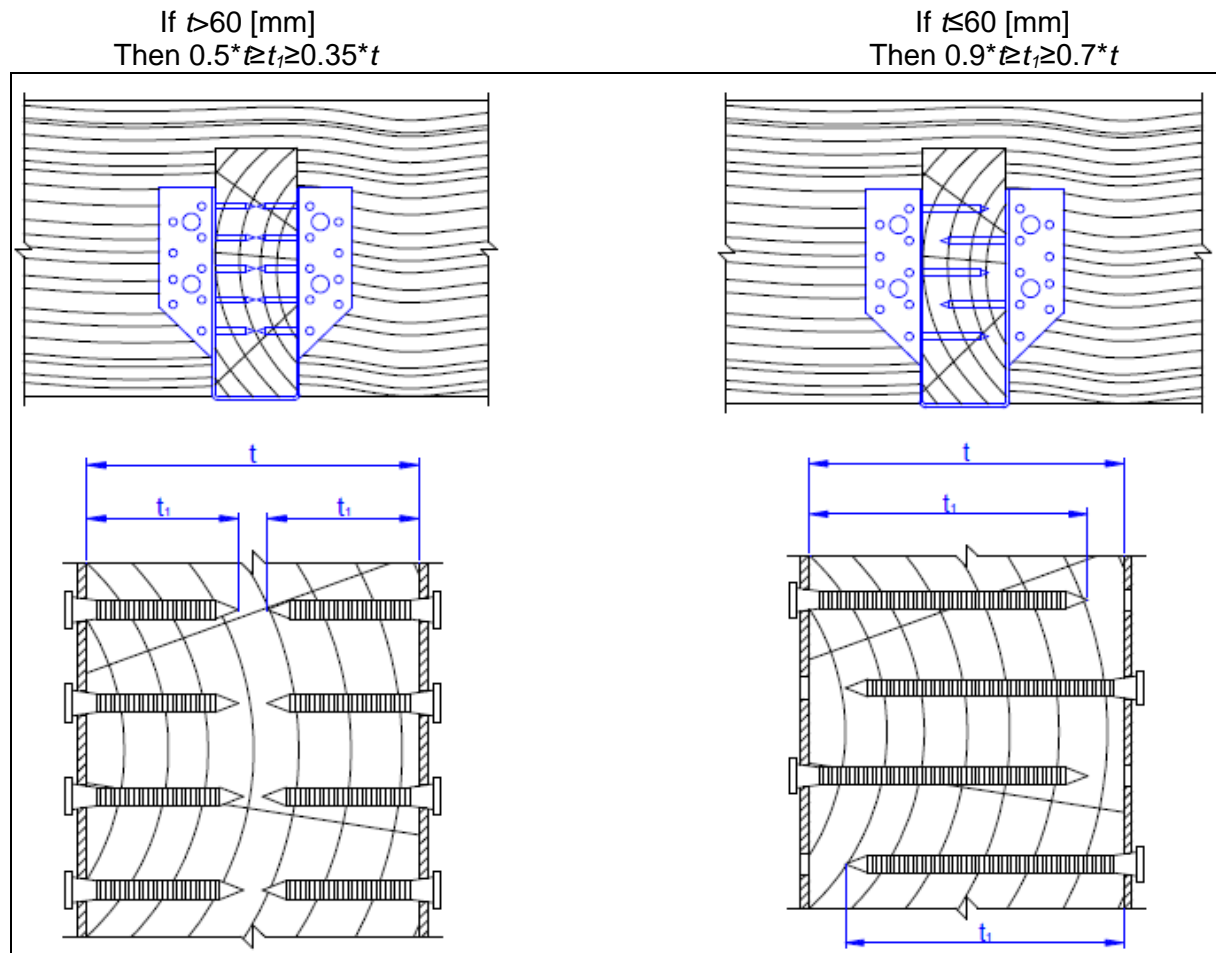

Figure 89 Rule for placement nails

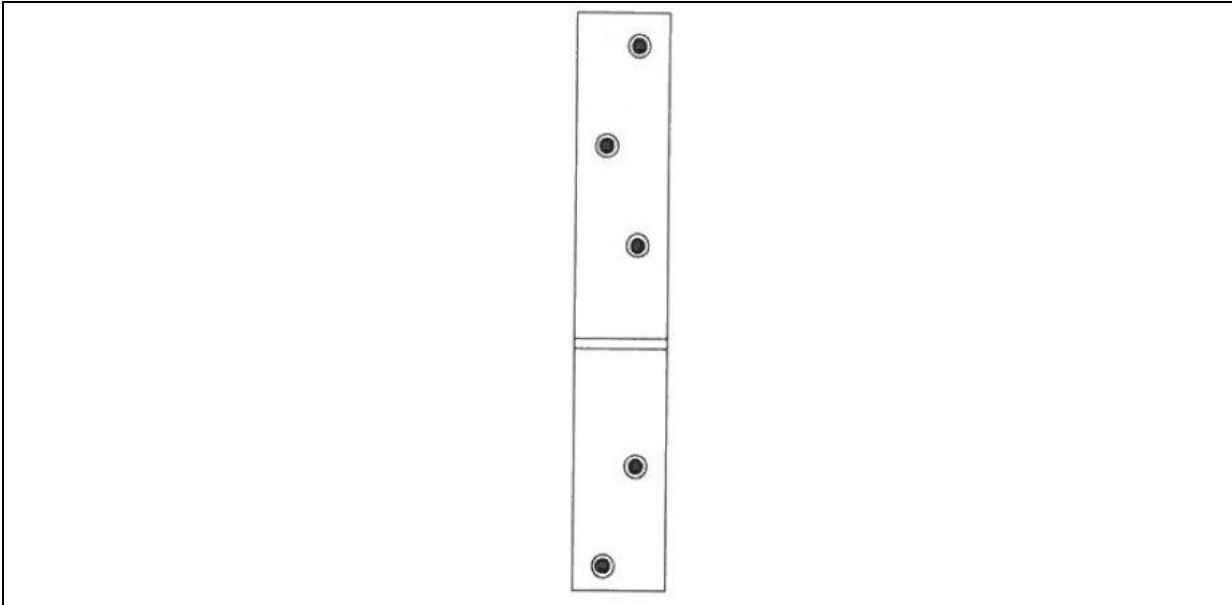

Figure 90 Type KB 1

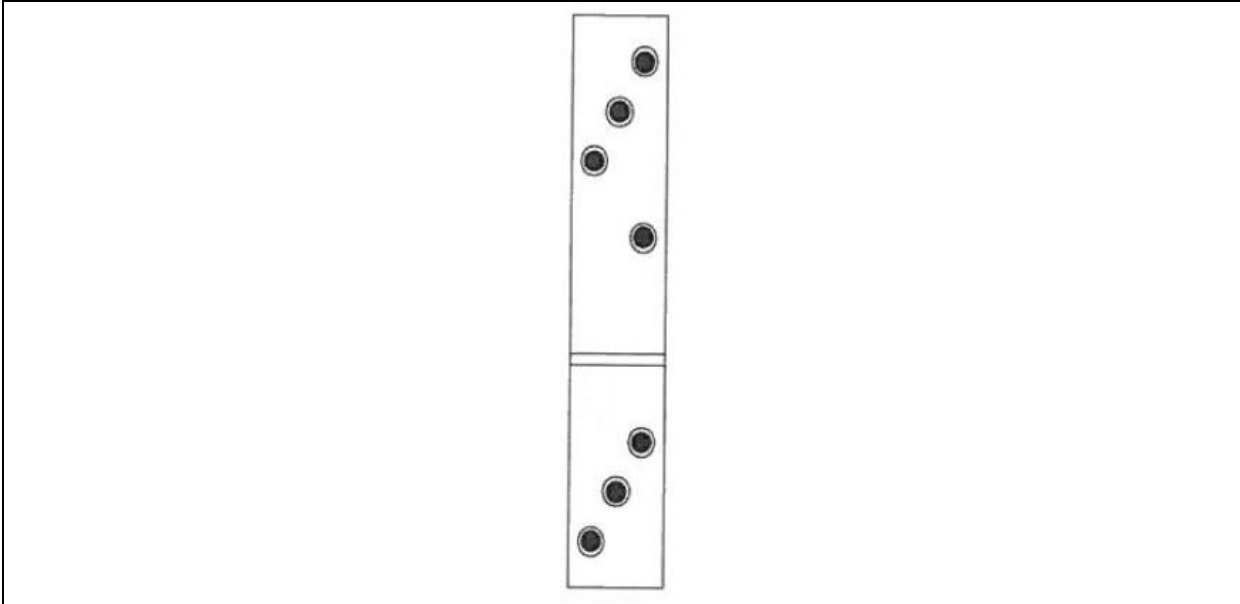

Figure 91 Type KB 2

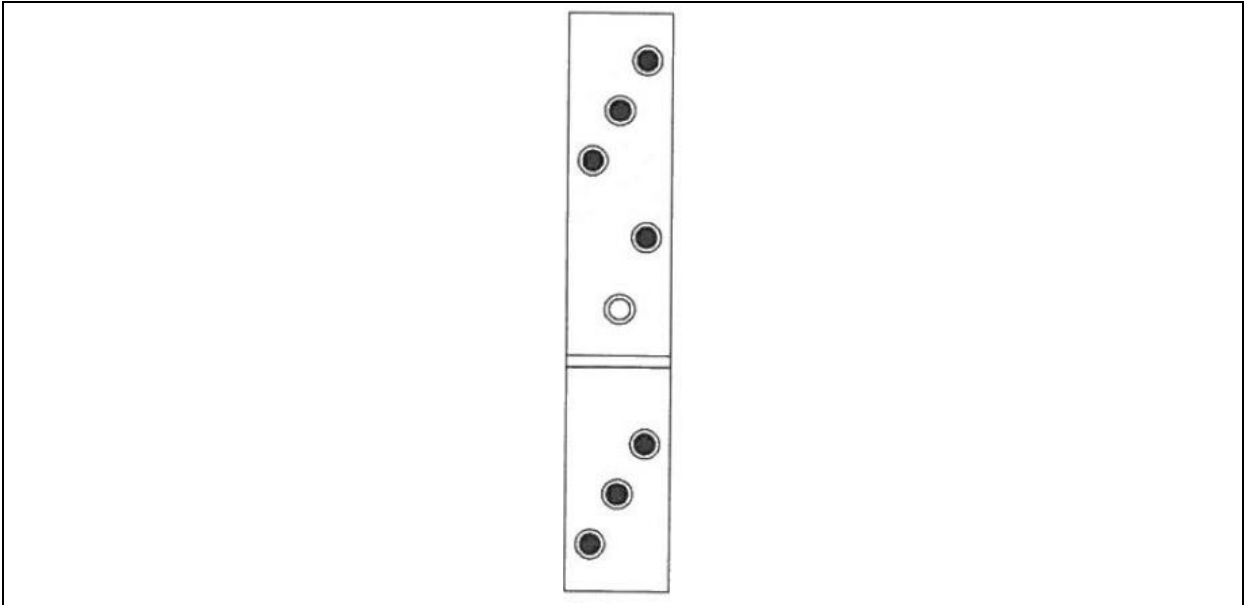

Figure 92 Type KB 3

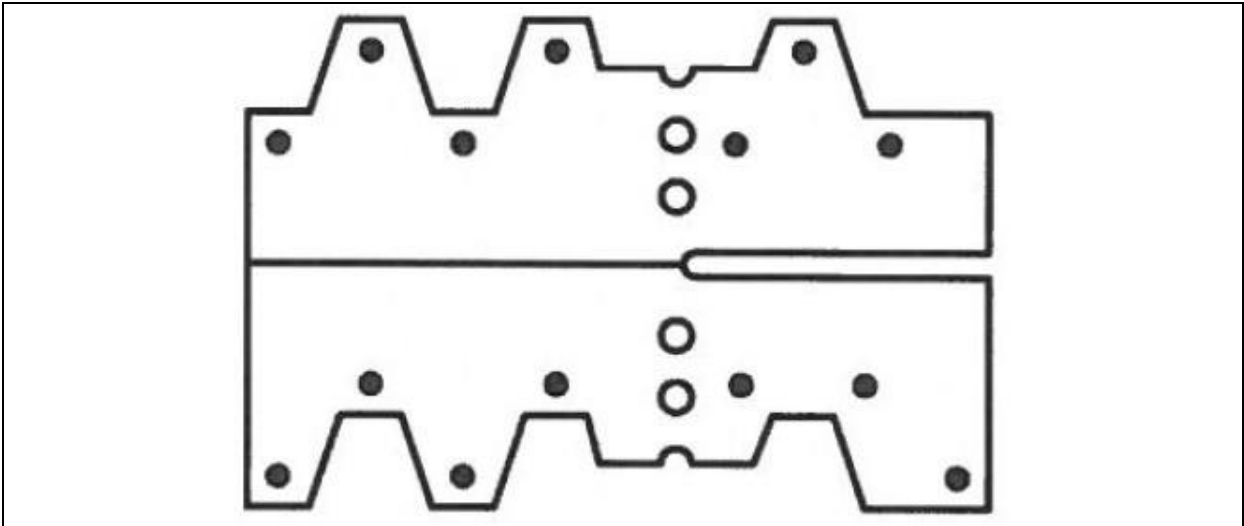

Figure 93 Type KG

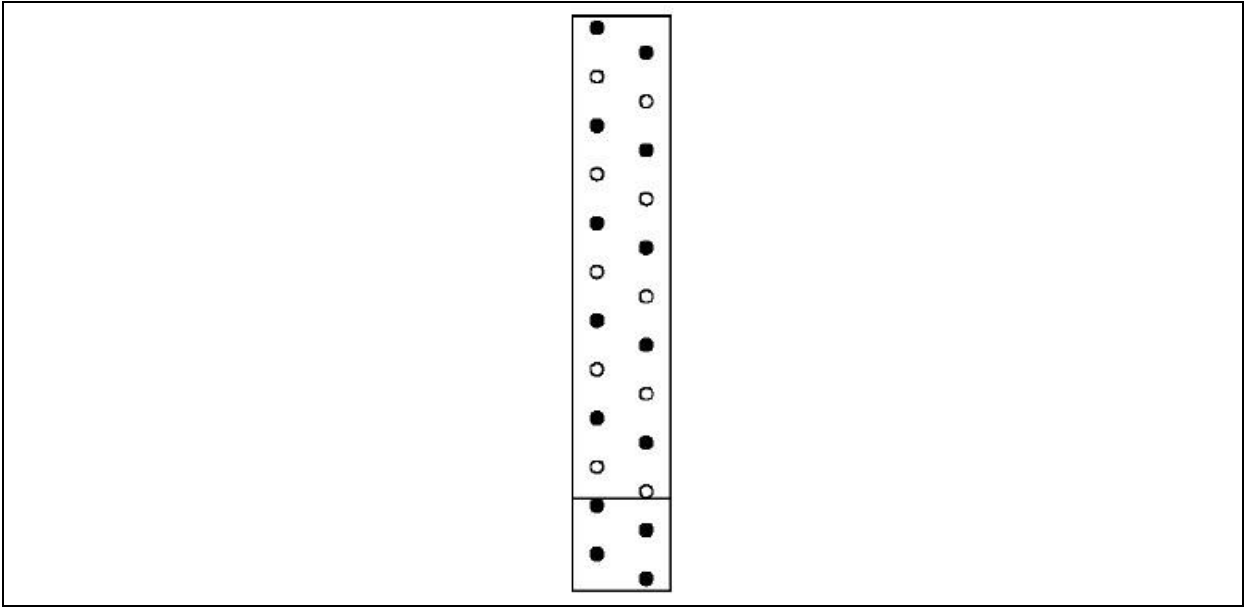

Figure 94 Type KK 1

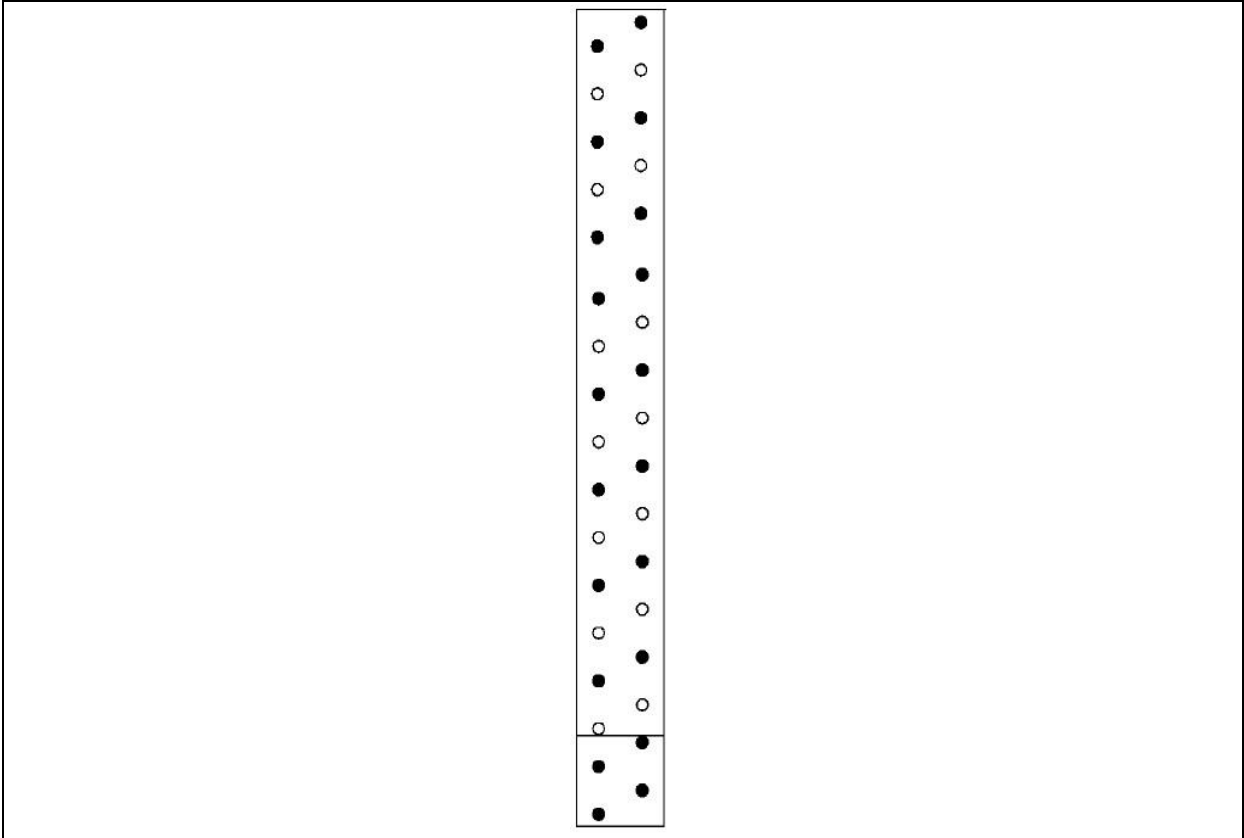

Figure 95 Type KK 2

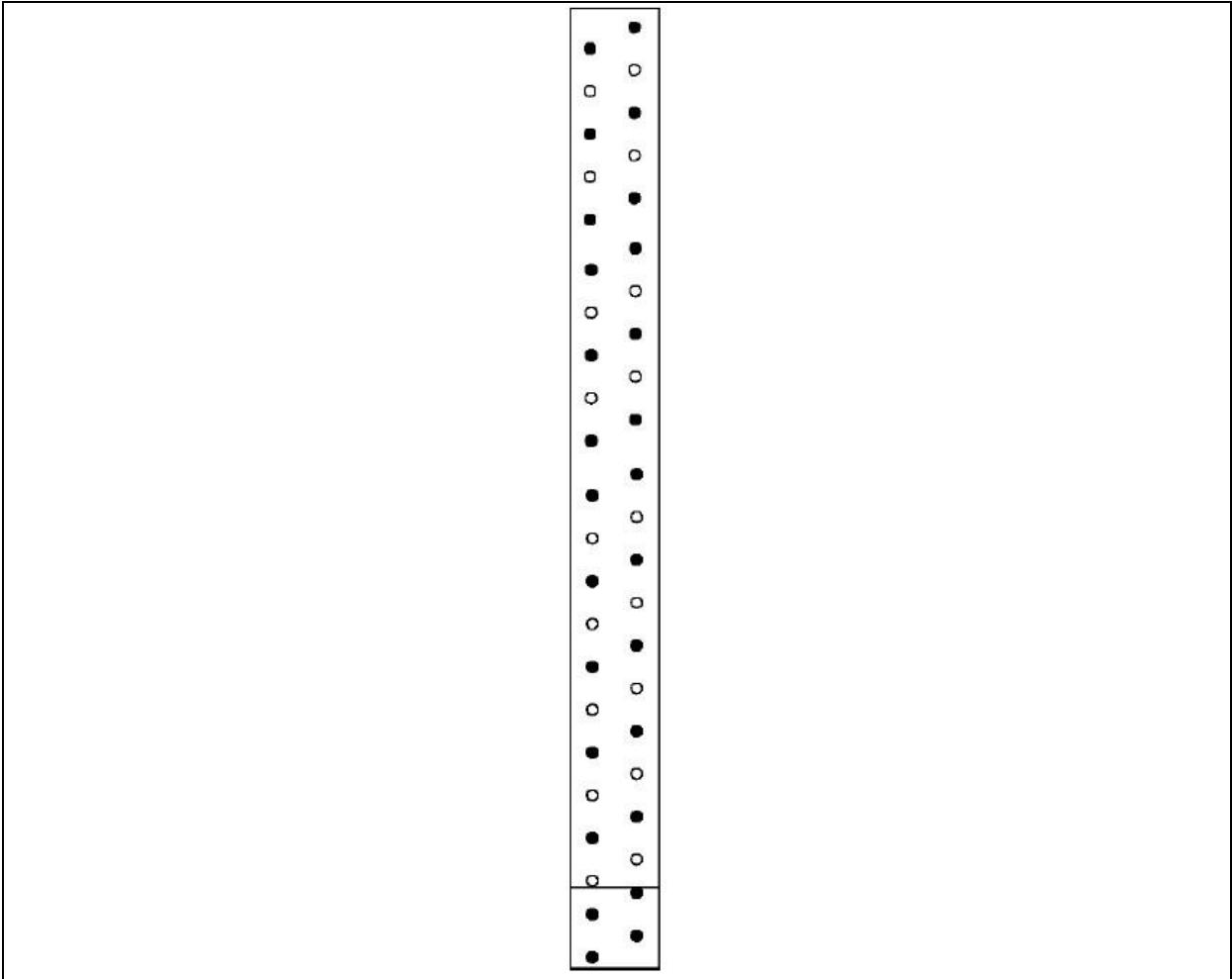

Figure 96 Type KK 3

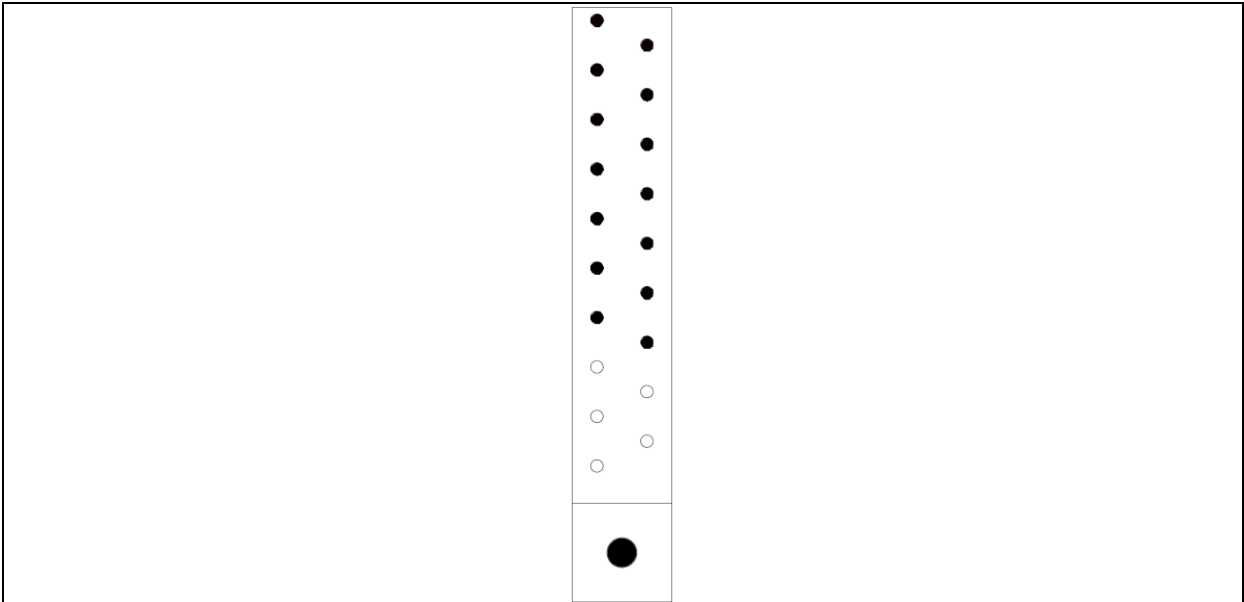

Figure 97 Type KK 21

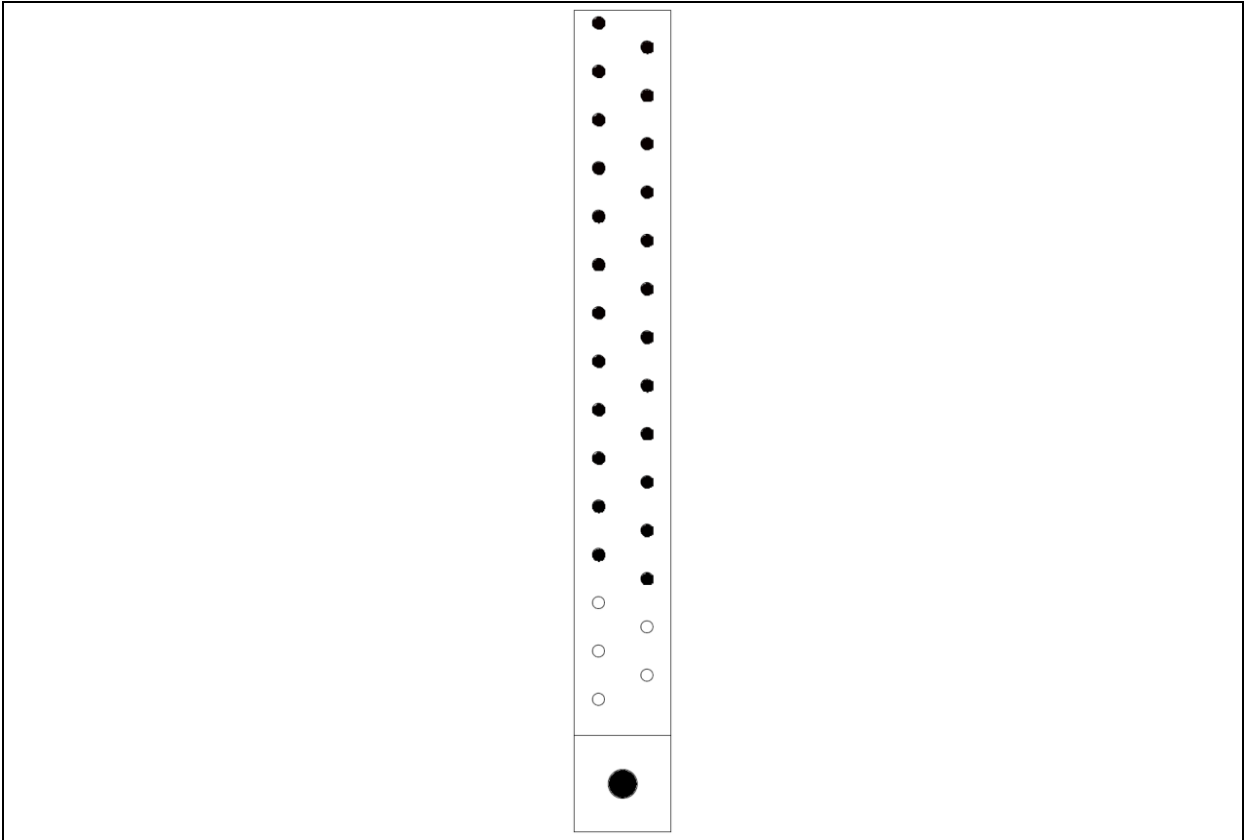

Figure 98 Type KK 22

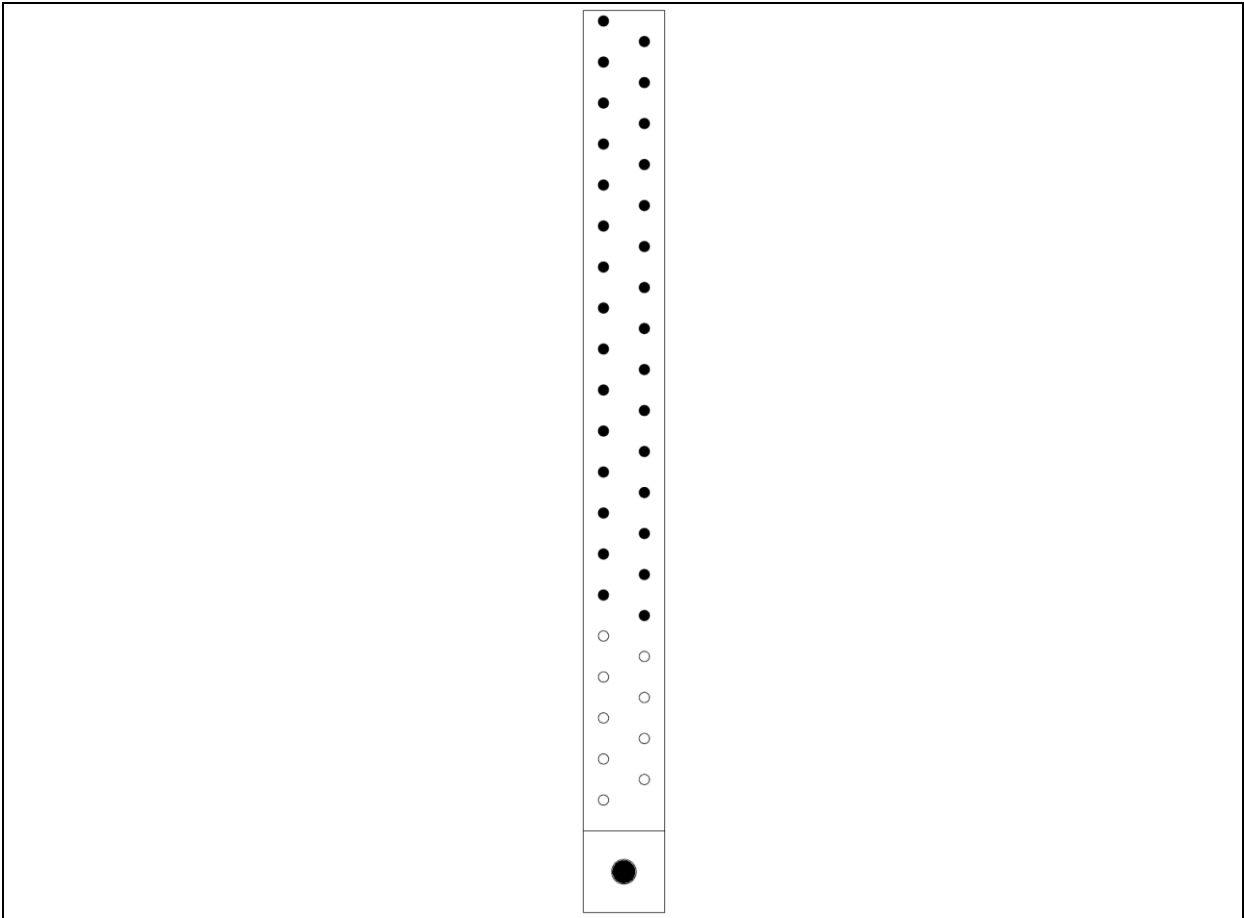

Figure 99 Type KK 23

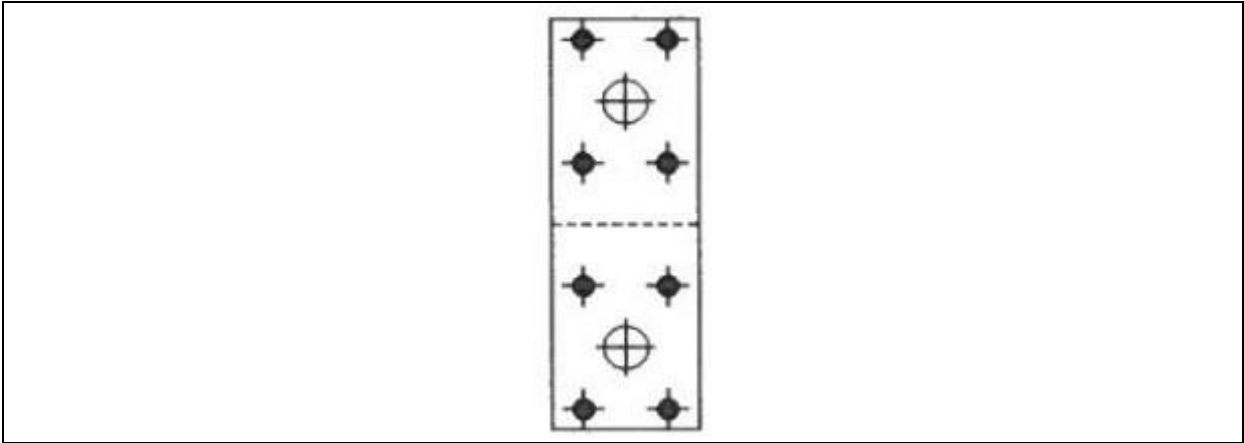

Figure 100 Type KL 1

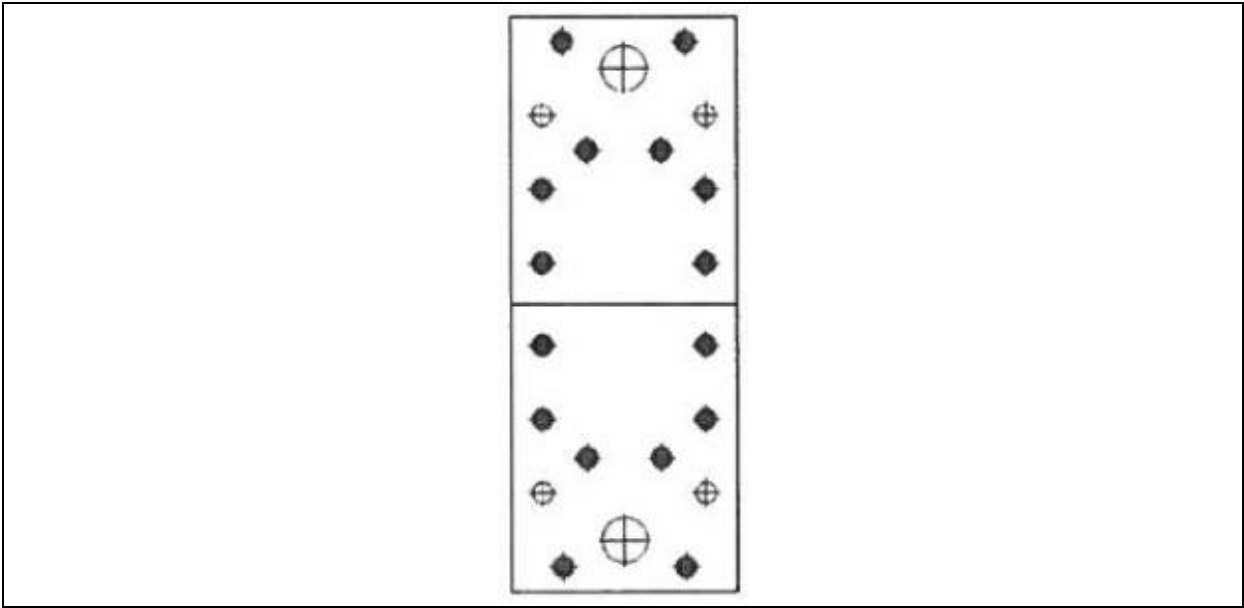

Figure 101 Type KL 2

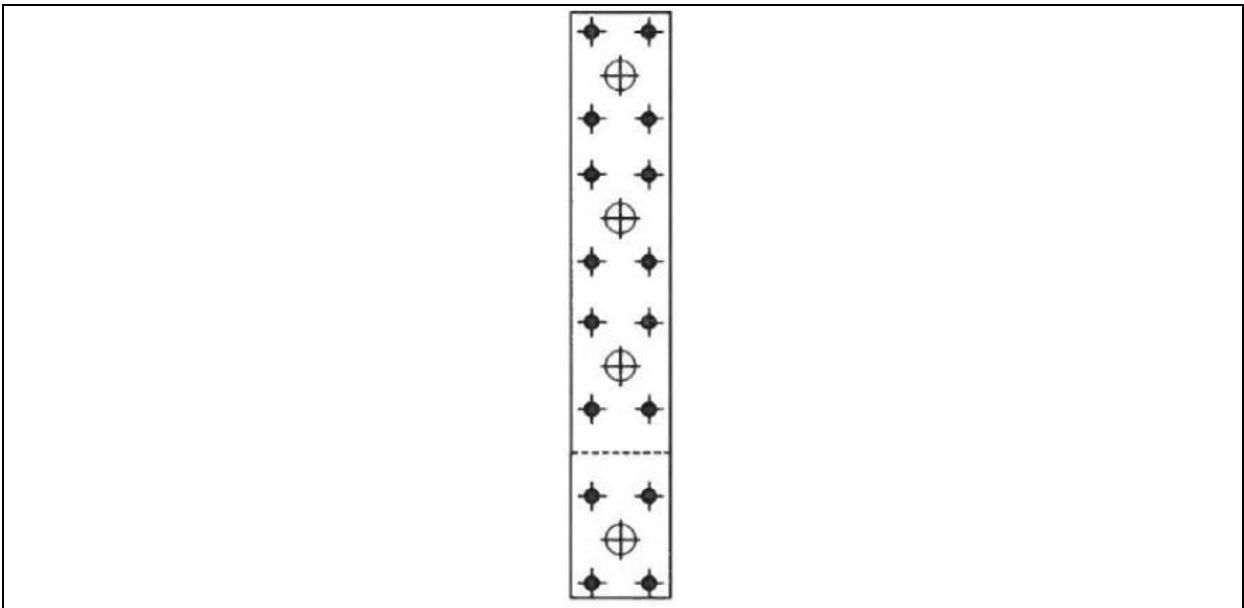

Figure 102 Type KL 3

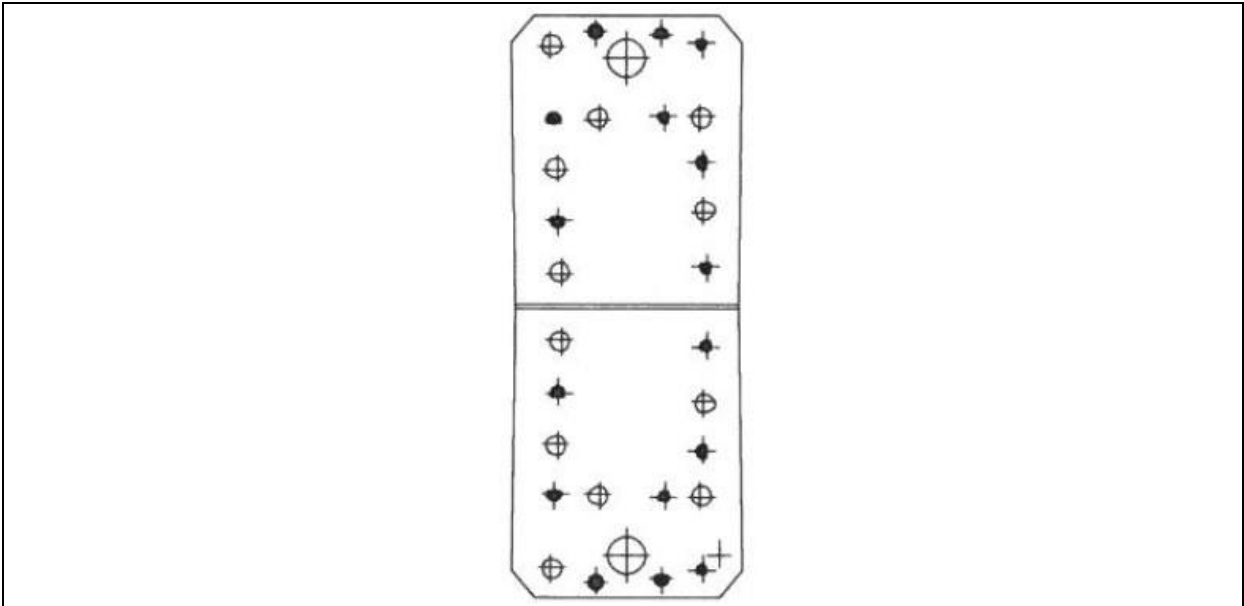

Figure 103 Type KL 4

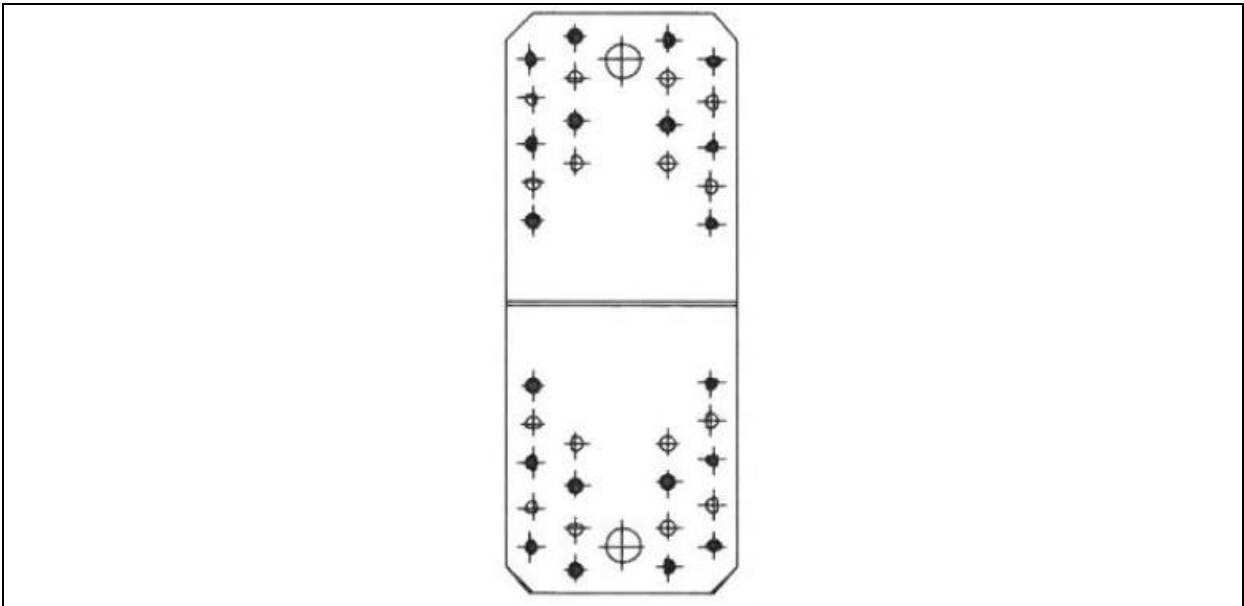

Figure 104 Type KL 5

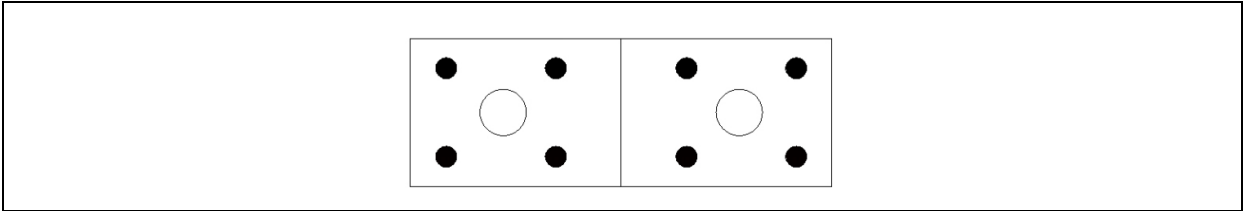

Figure 105 Type KL 101

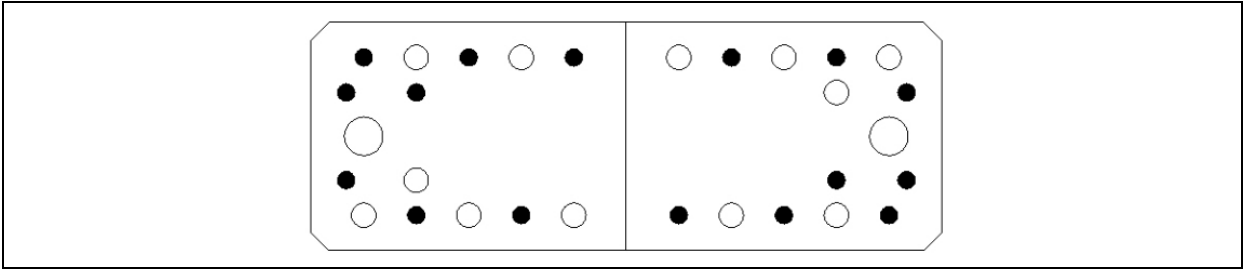

Figure 106 Type KL 104

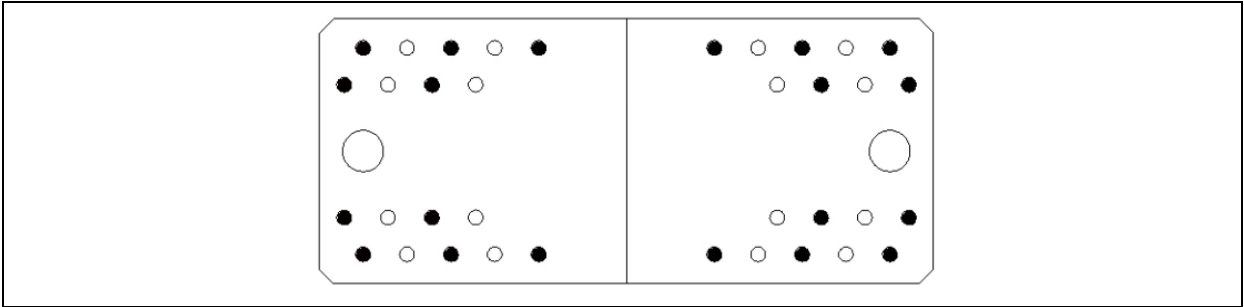

Figure 107 Type KL 105

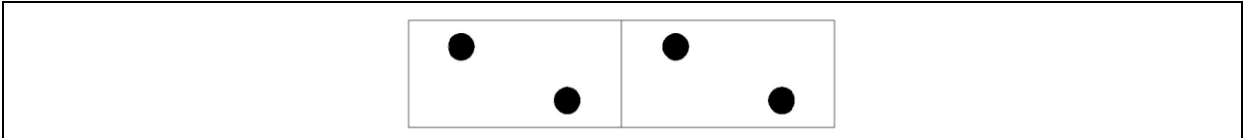

Figure 108 Type KM 0

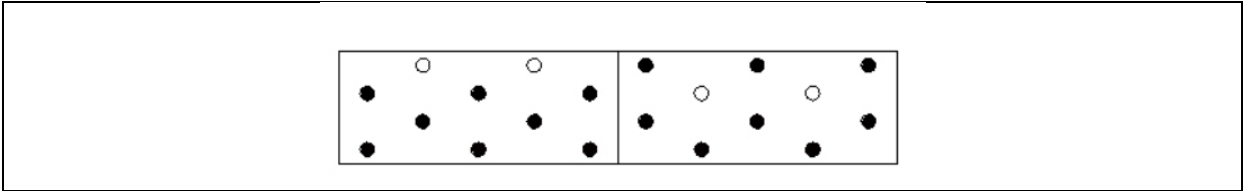

Figure 109 Type KM 21

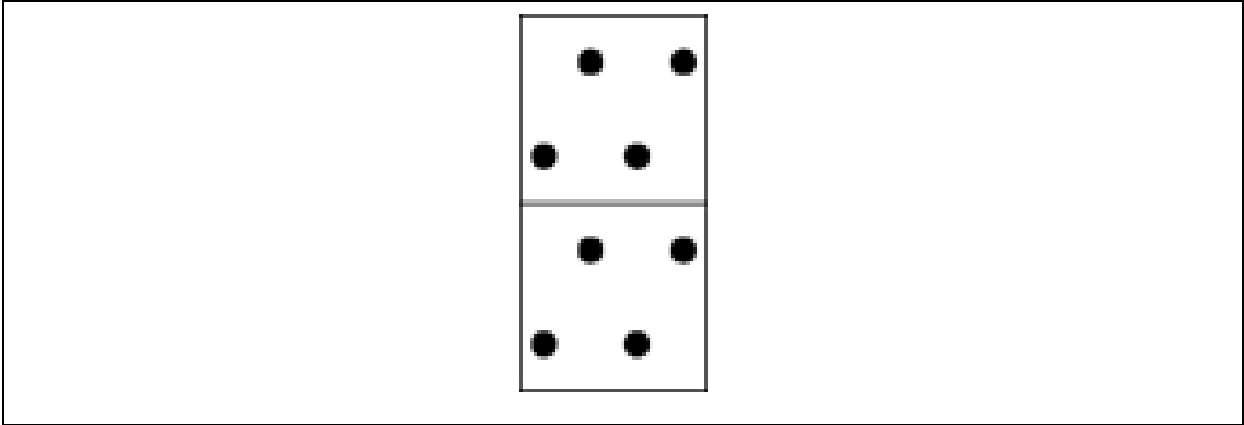

Figure 110 Type KM 1 (2.5 mm)

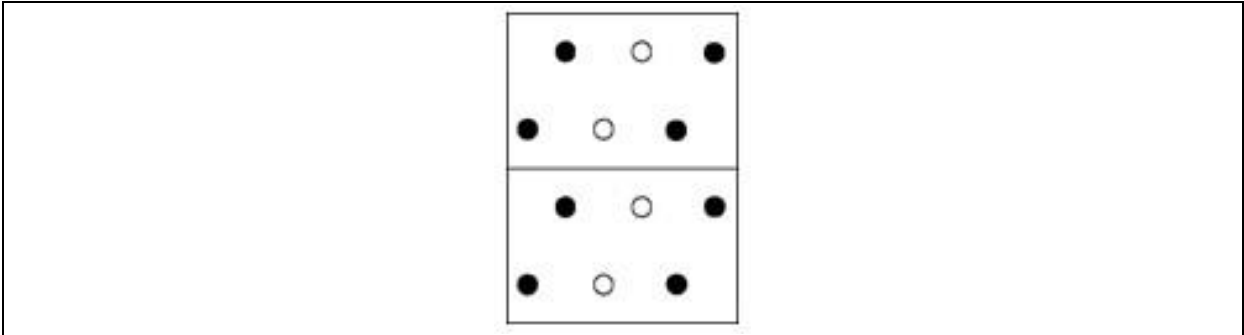

Figure 111 Type KM 2 (2.5 mm)

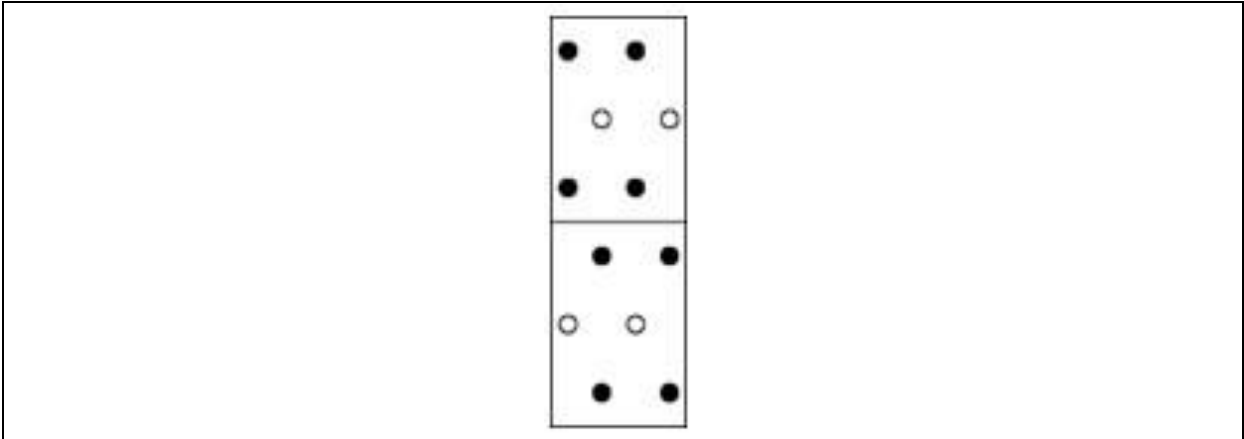

Figure 112 Type KM 3

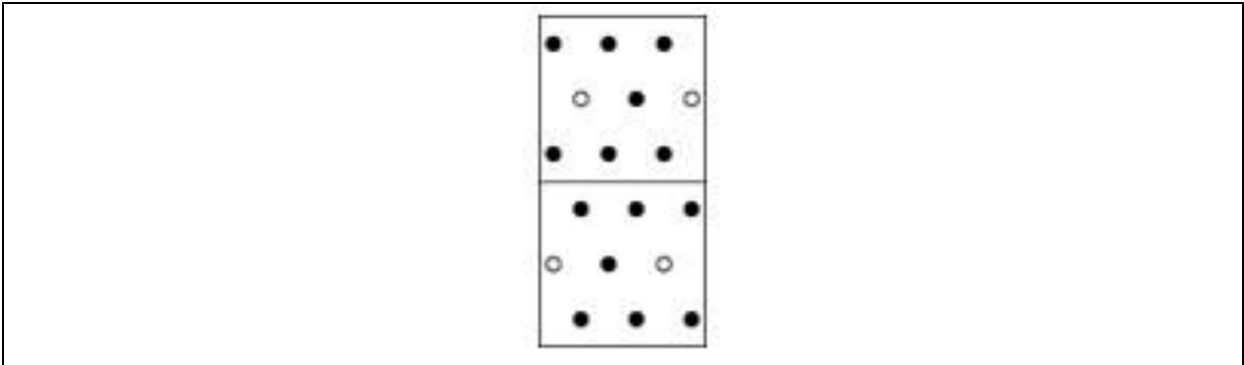

Figure 113 Type KM 4 (2.5 mm)

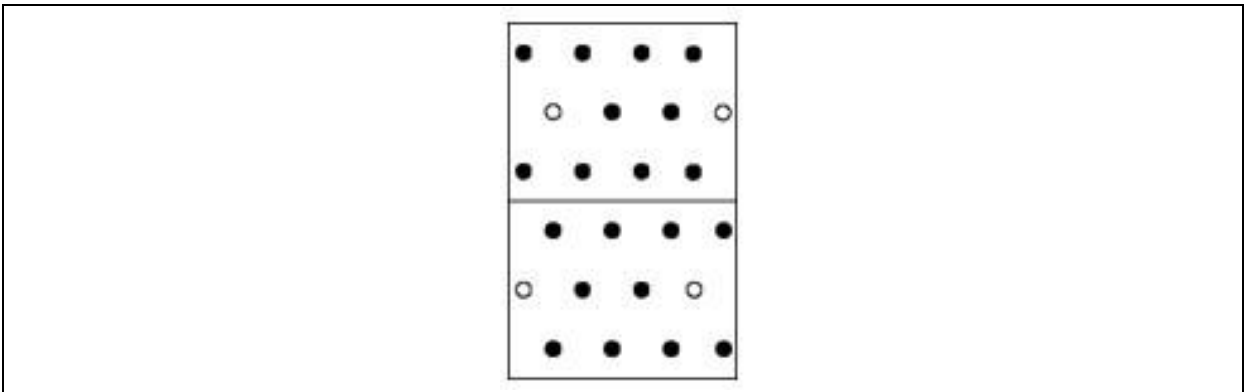

Figure 114 Type KM 5 (2.5 mm)

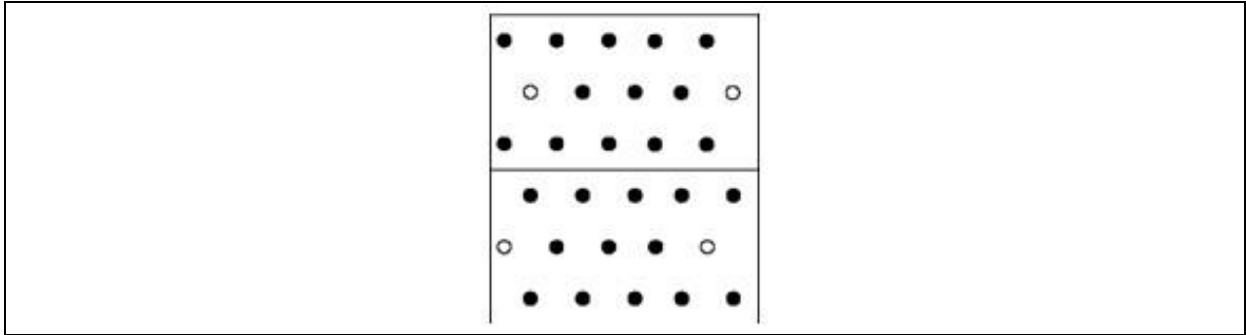

Figure 115 Type KM 6 (2.5 mm)

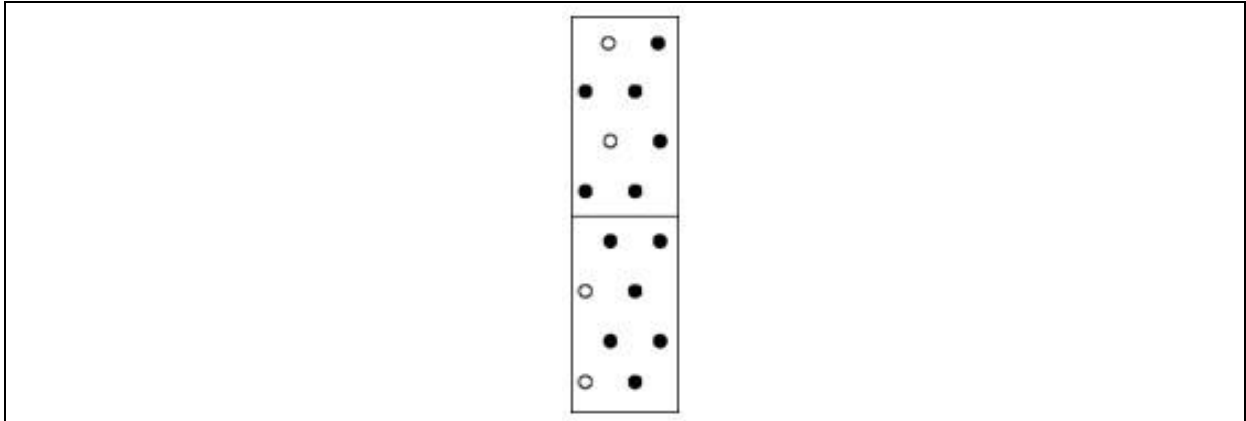

Figure 116 Type KM 7 (2.5 mm)

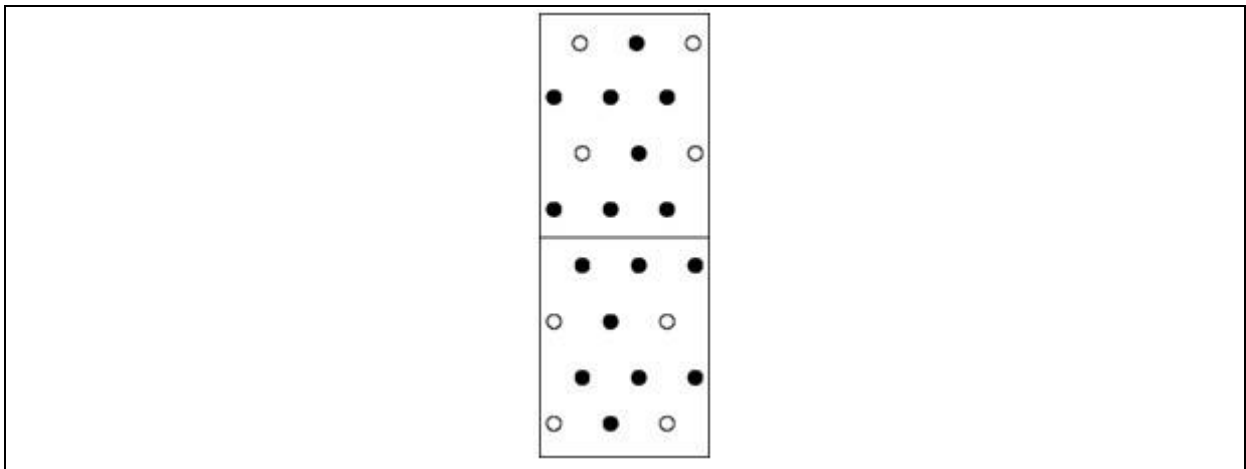

Figure 117 Type KM 8

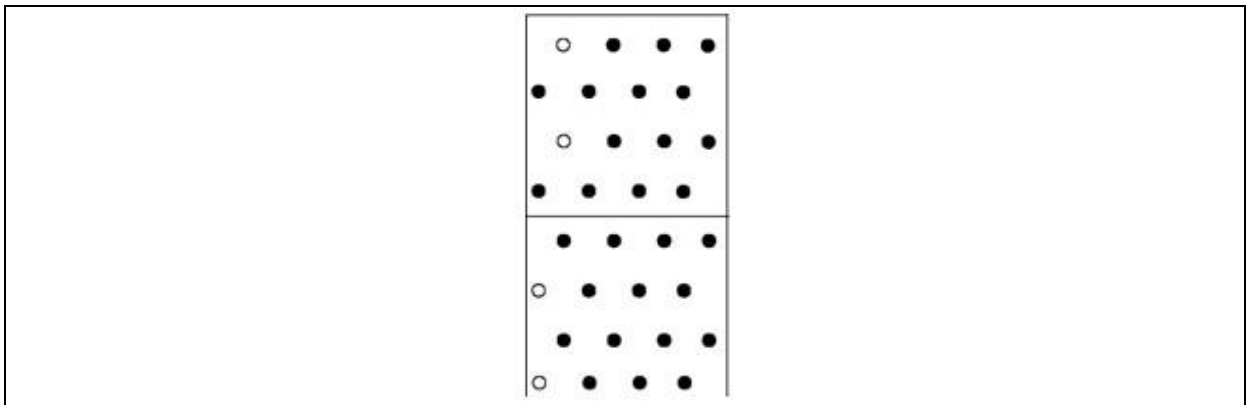

Figure 118 Type KM 9 (2.5 mm)

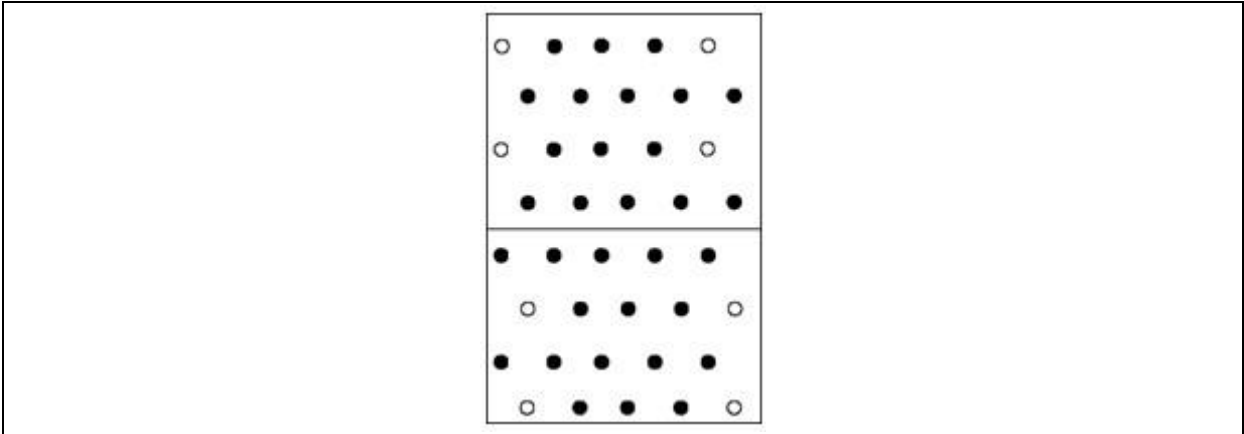

Figure 119 Type KM 10 (2.5 mm)

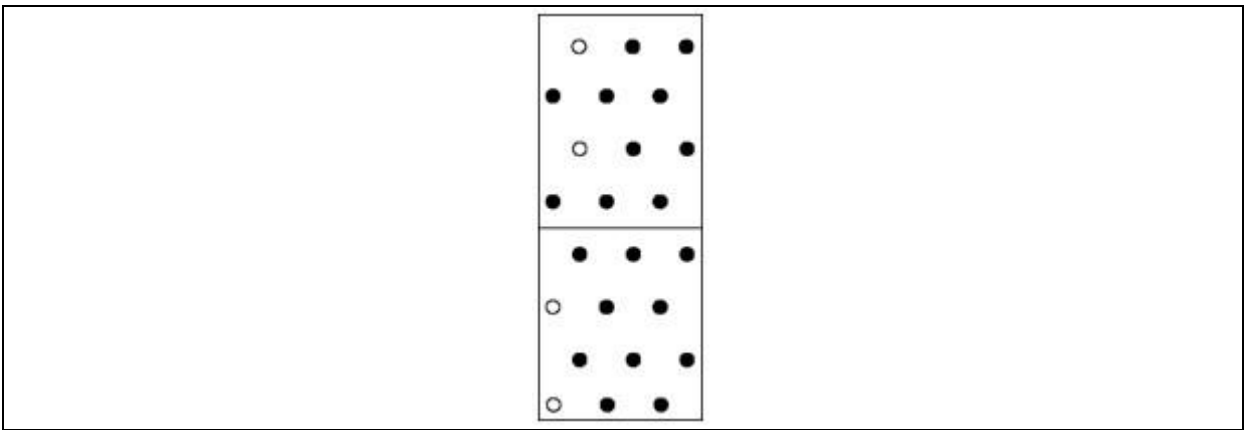

Figure 120 Type KM 11 (2.5 mm)

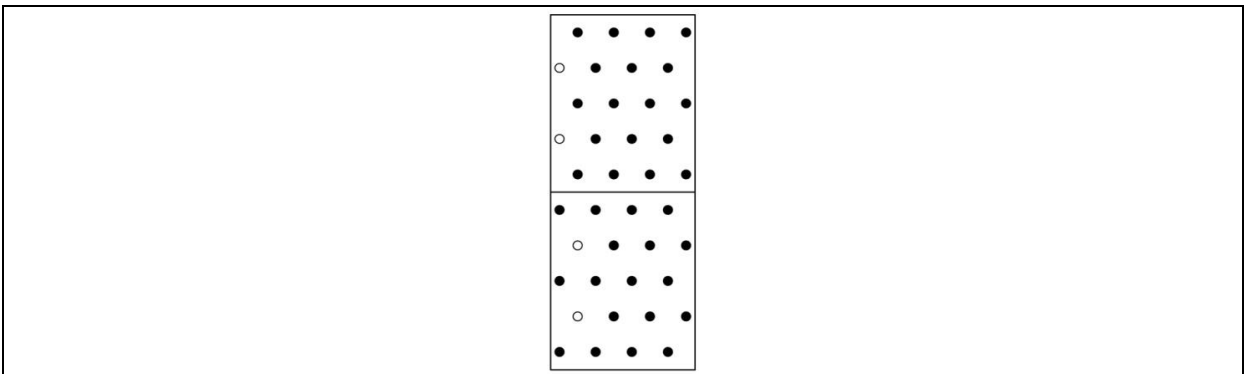

Figure 121 Type KM 12 (2.5 mm)

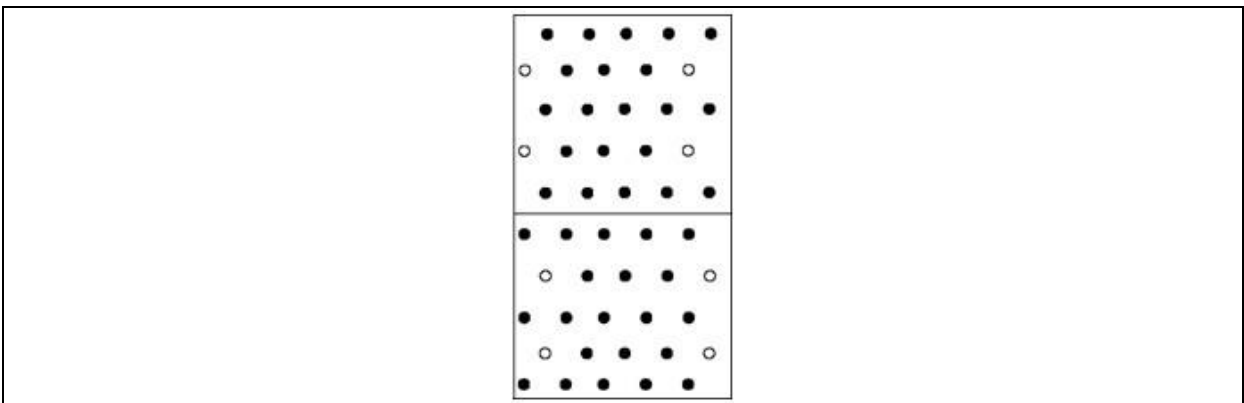

Figure 122 Type KM 13 (2.5 mm)

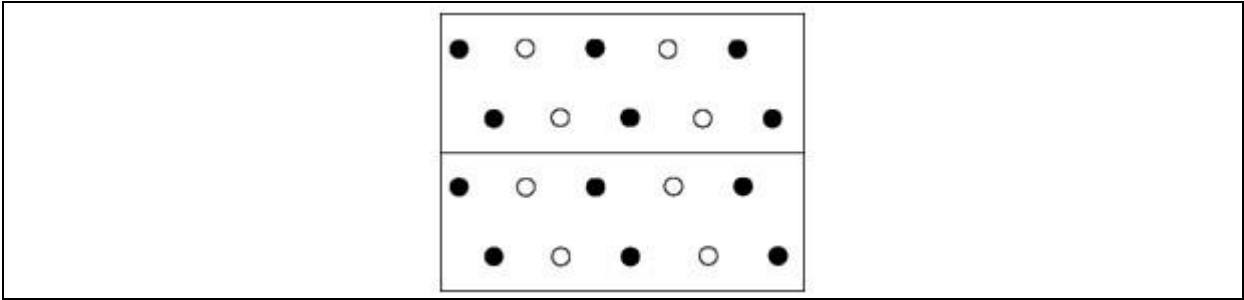

Figure 123 Type KM 14 (2.5 mm)

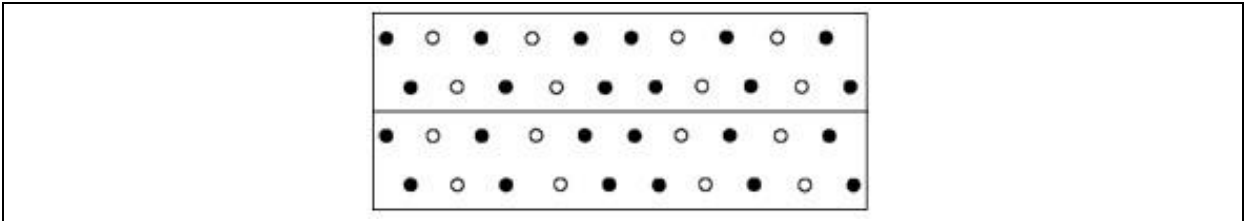

Figure 124 Type KM 15 (2.5 mm)

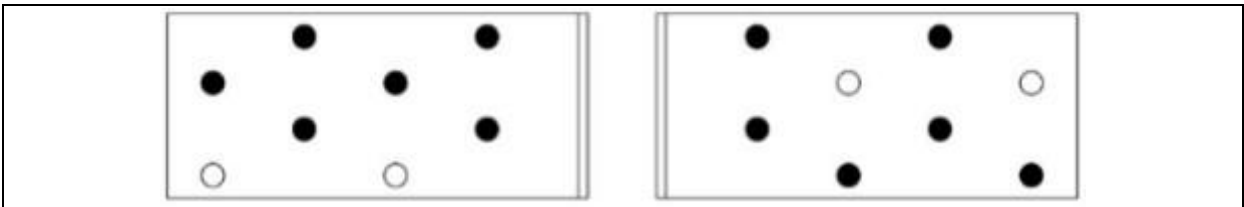

Figure 125 Type KM 16 (2.5 mm)

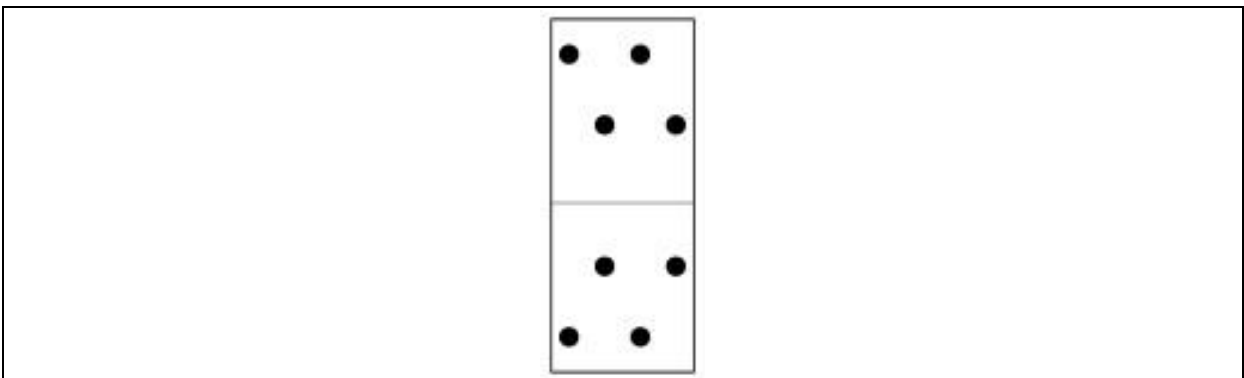

Figure 126 Type KM 17 (2.5 mm)

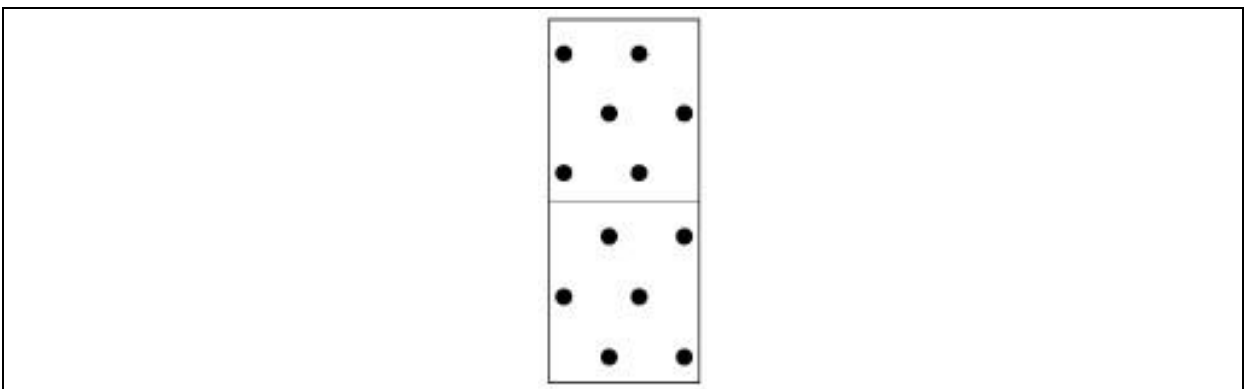

Figure 127 Type KM 18 (2.5 mm)

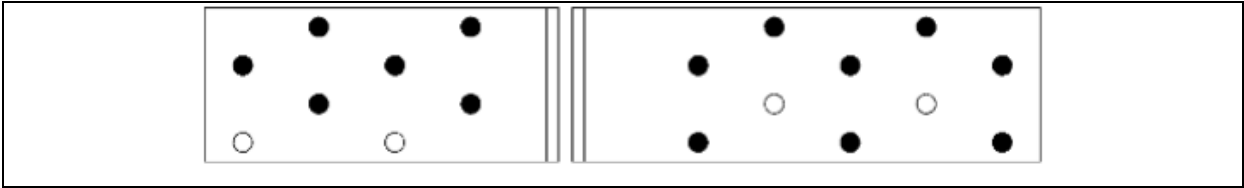

Figure 128 Type KM 19 (2.5 mm)

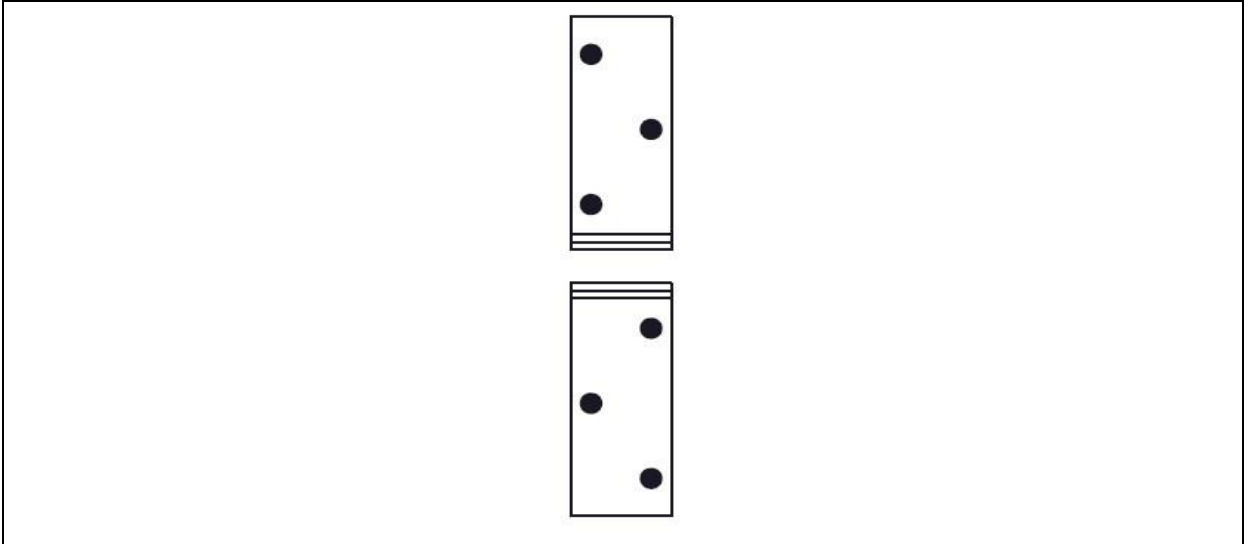

Figure 129 Type KM 20 (2.5 mm)

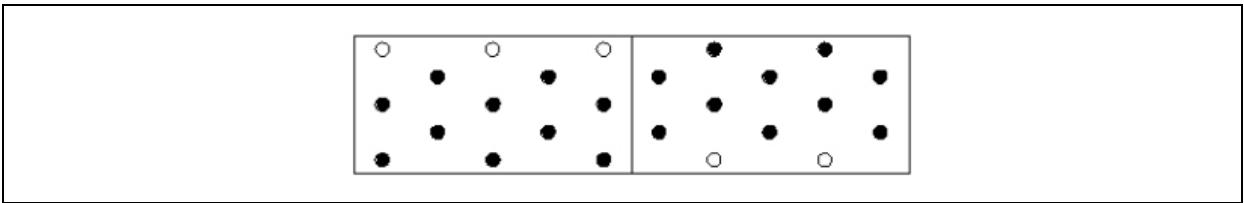

Figure 130 Type KM 22 (2.5 mm)

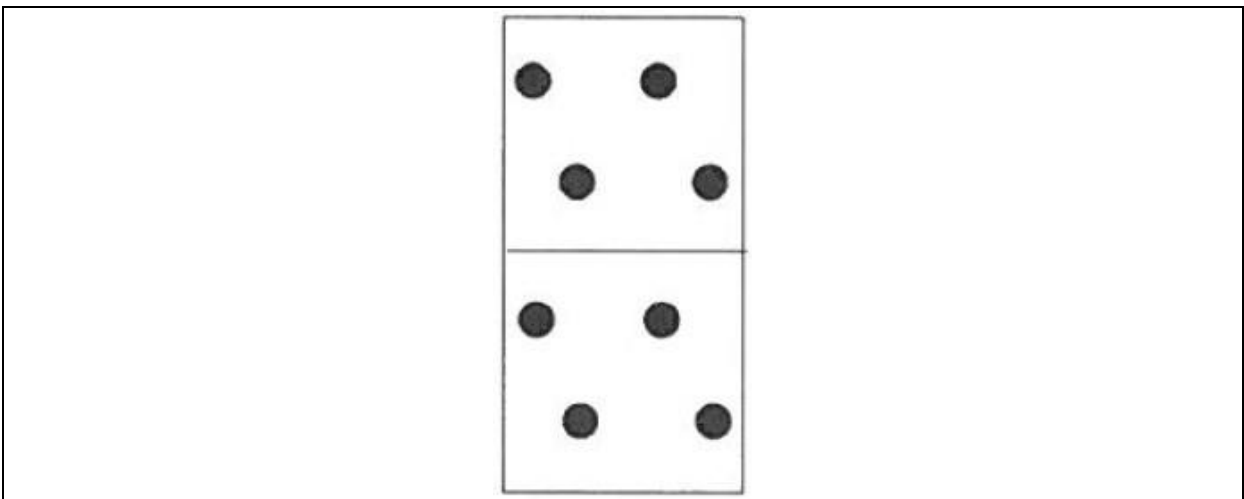

Figure 131 Type KMP 1

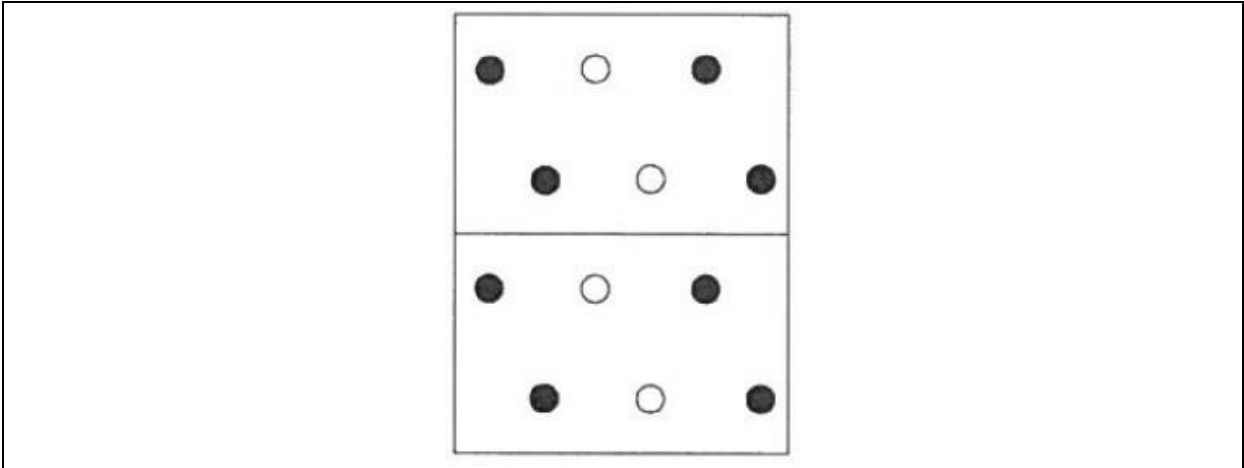

Figure 132 Type KMP 2

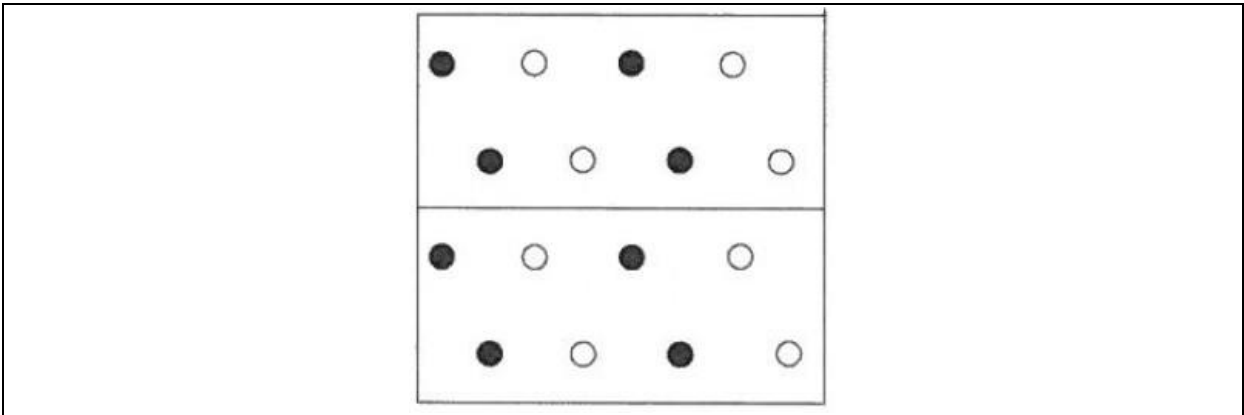

Figure 133 Type KMP 3

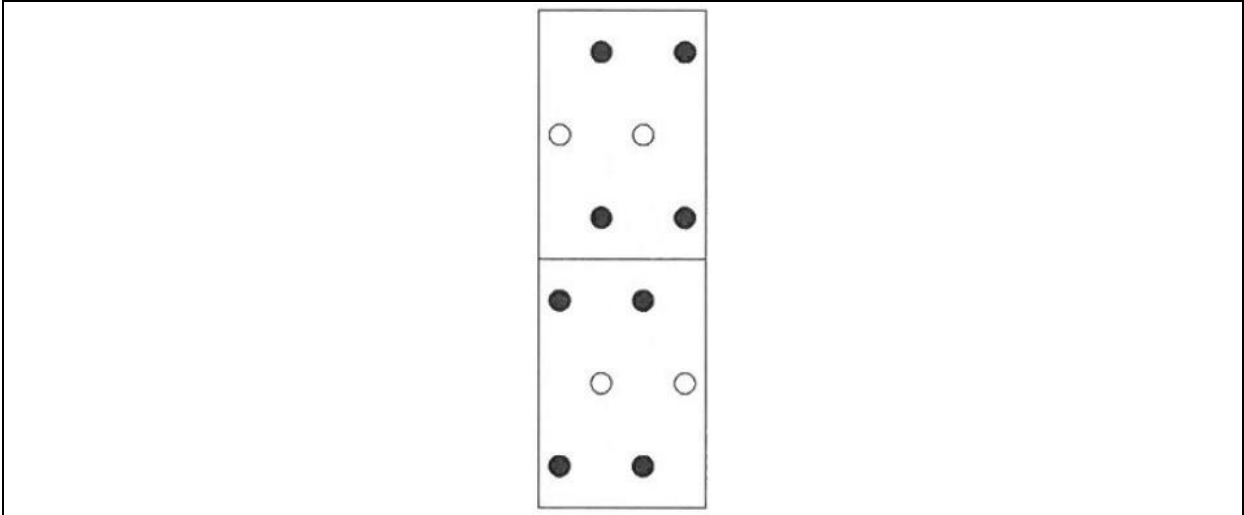

Figure 134 Type KMP 4

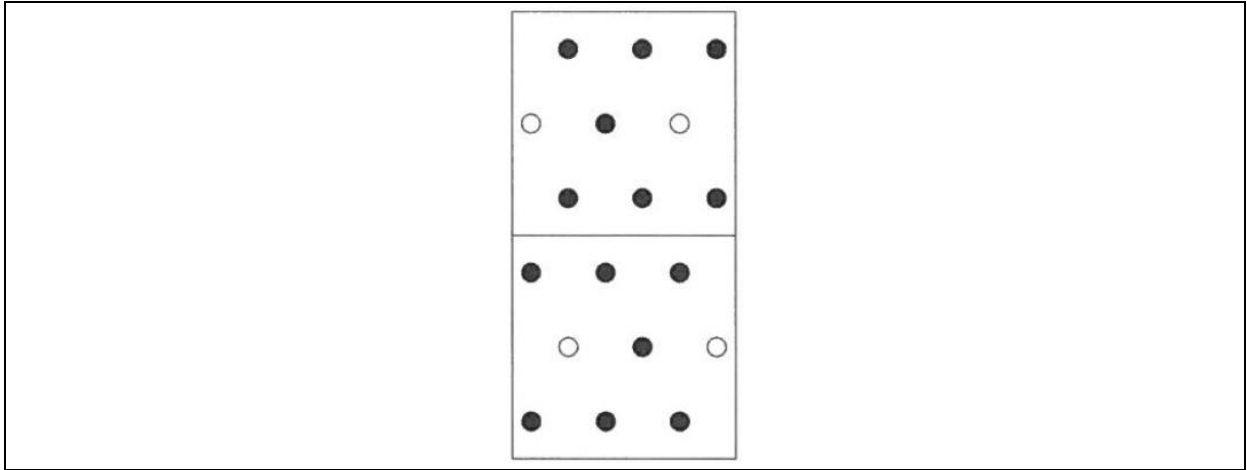

Figure 135 Type KMP 5

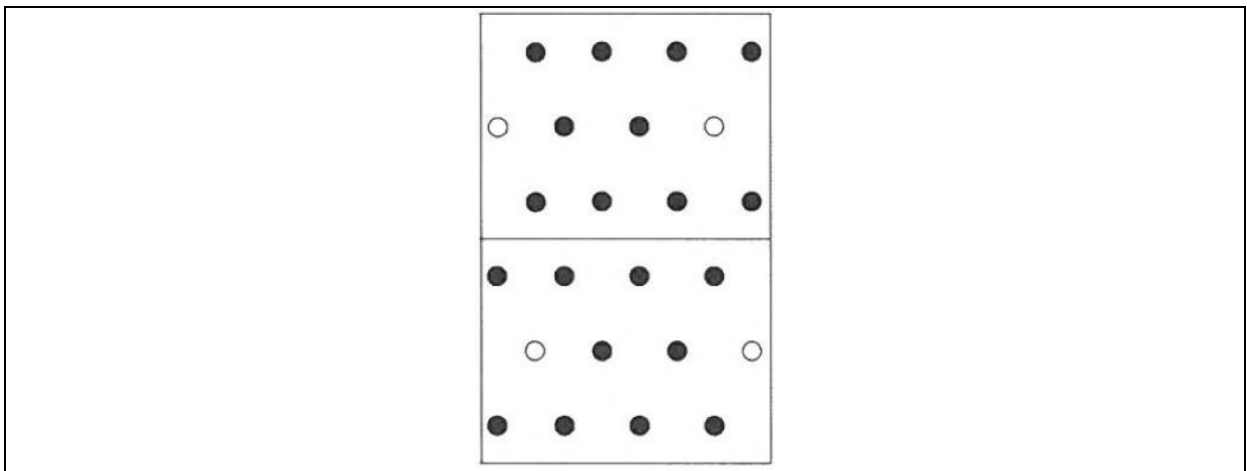

Figure 136 Type KMP 6

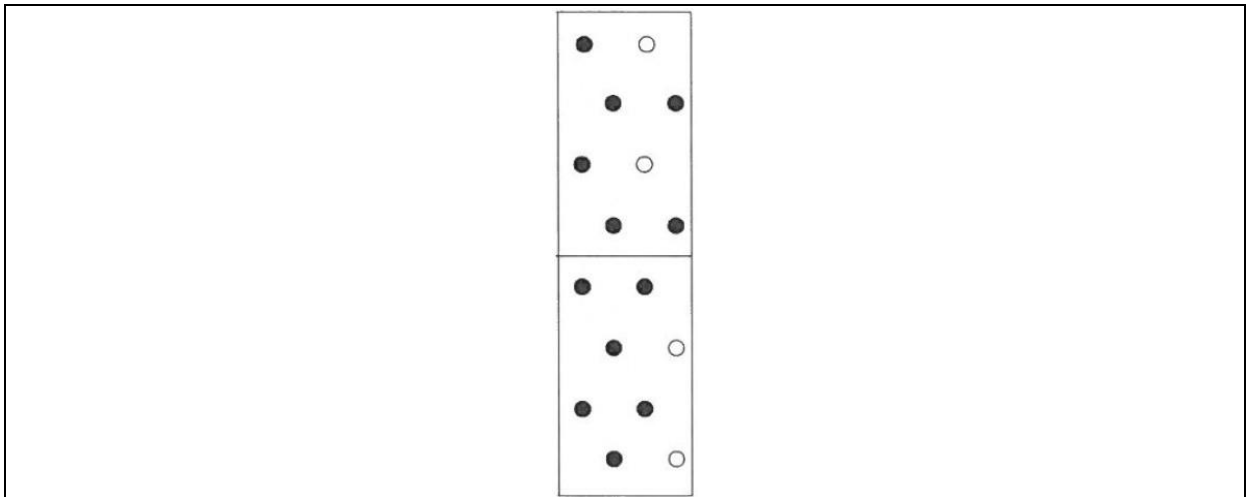

Figure 137 Type KMP 7

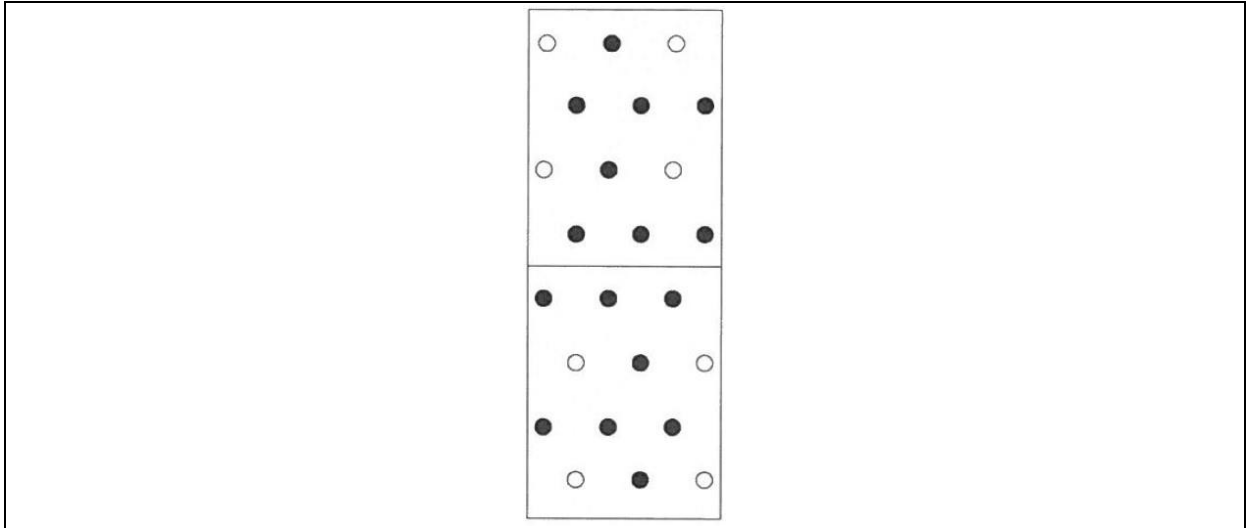

Figure 138 Type KMP 8

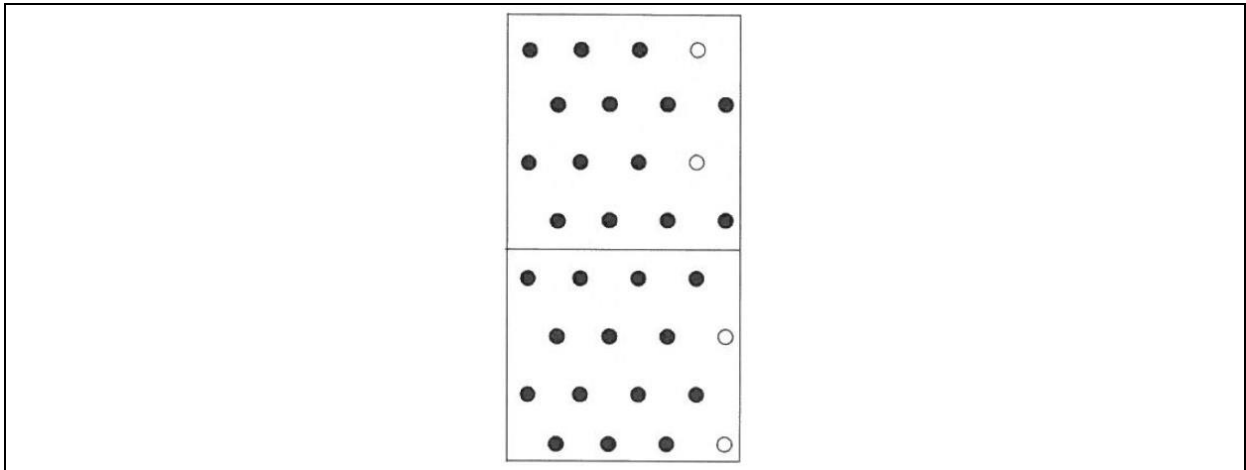

Figure 139 Type KMP 9

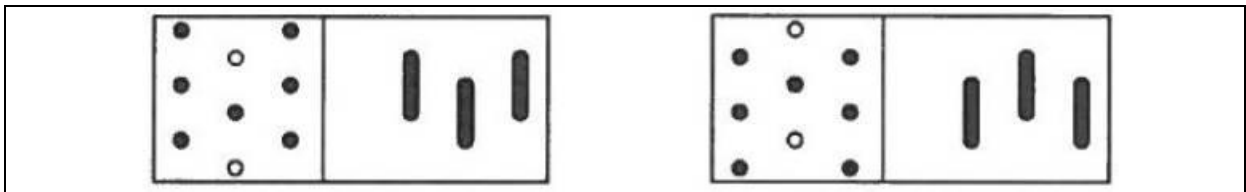

Figure 140 Type KMR 1 and KMR 2

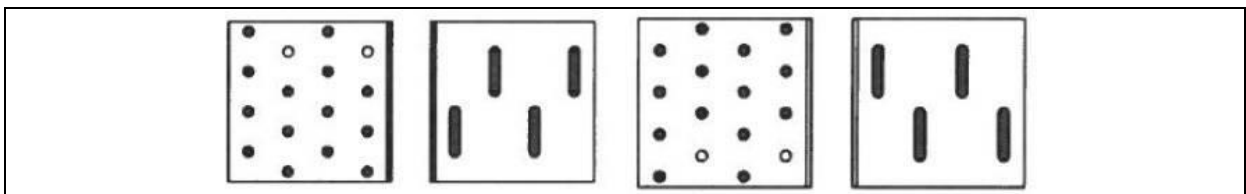

Figure 141 Type KMR 3 and KMR 4

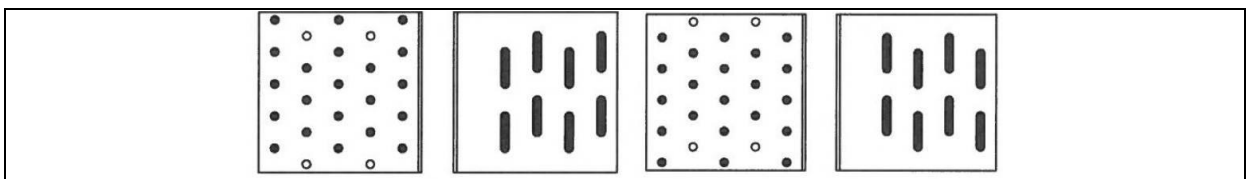

Figure 142 Type KMR 5 and KMR 6

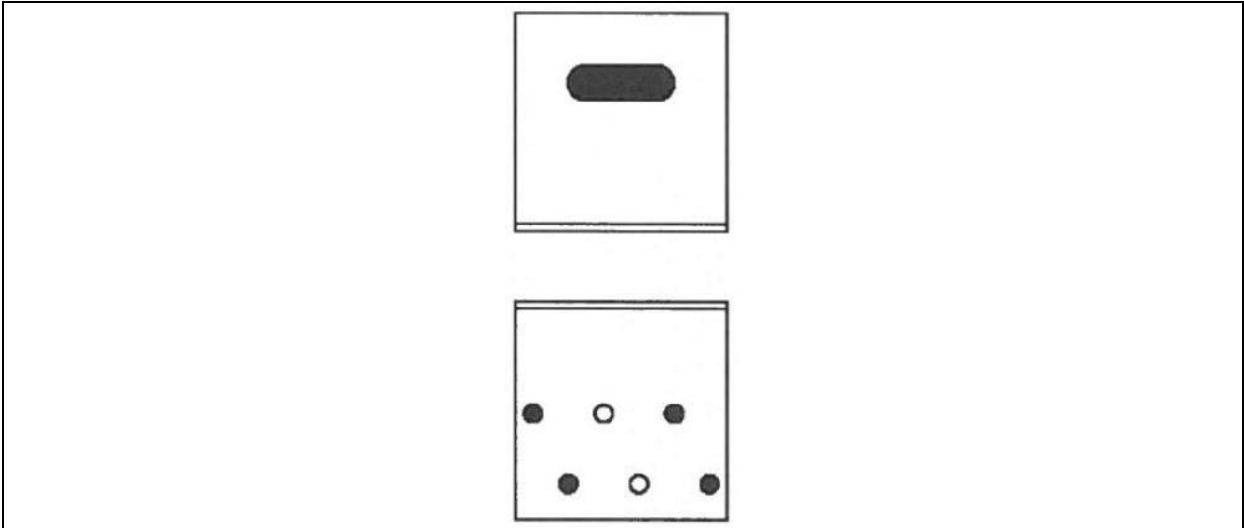

Figure 143 Type KMR 7

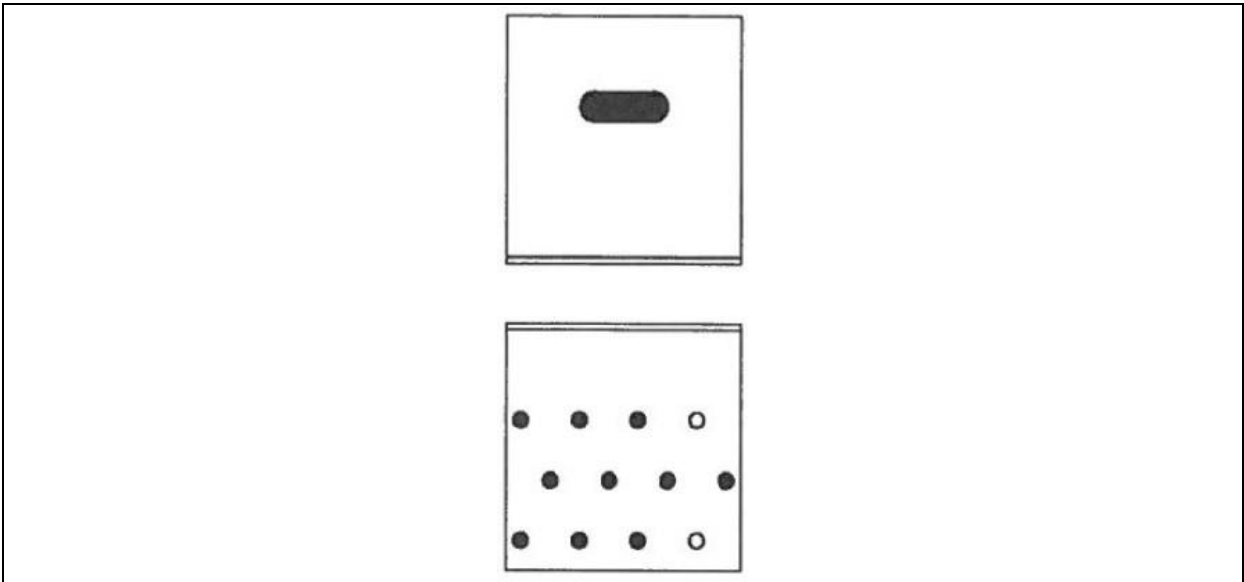

Figure 144 Type KMR 8

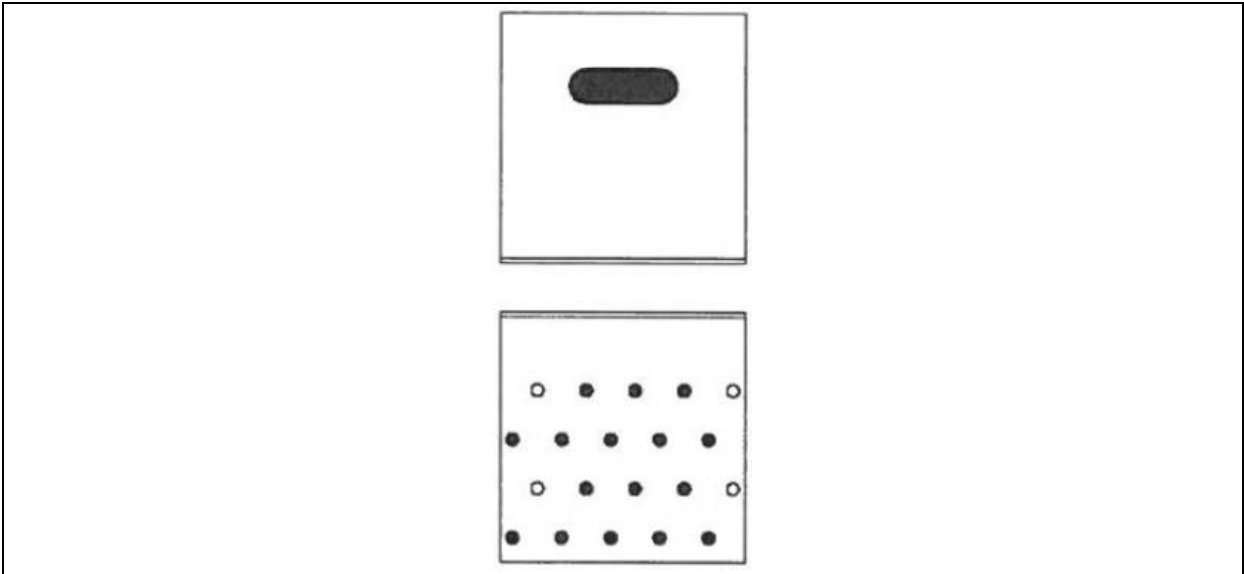

Figure 145 Type KMR 9

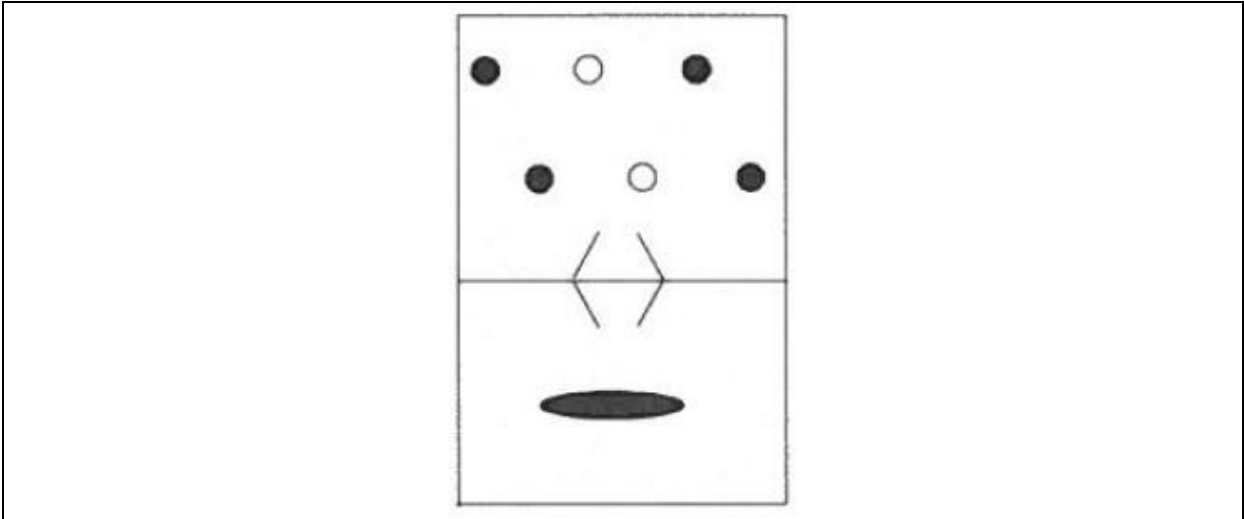

Figure 146 Type KMRP 1

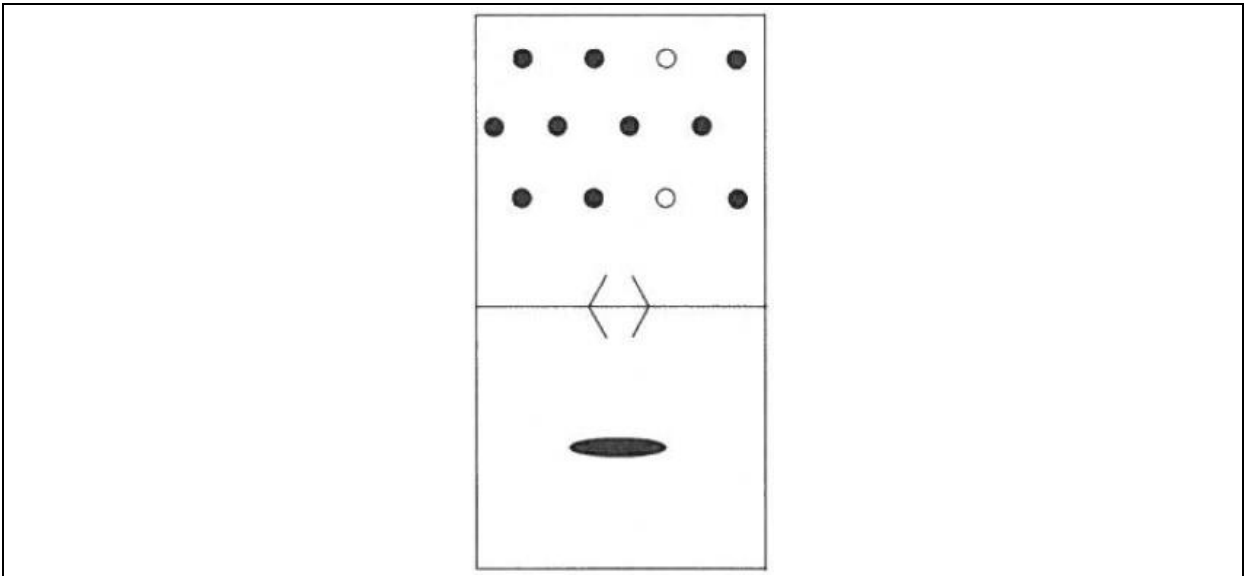

Figure 147 Type KMRP 2

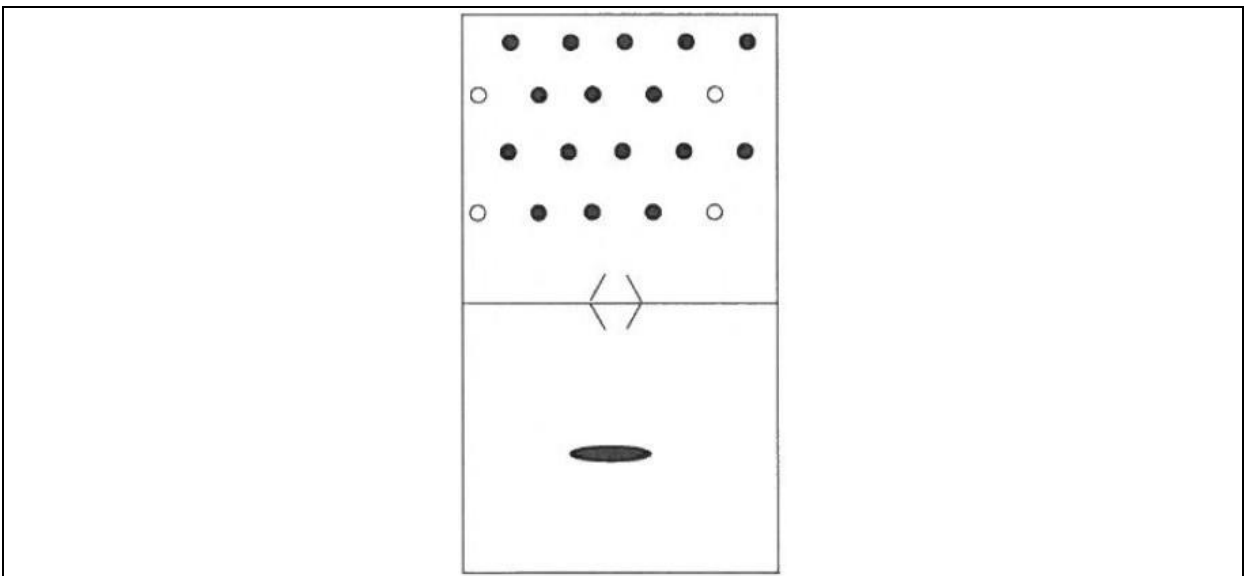

Figure 148 Type KMRP 3

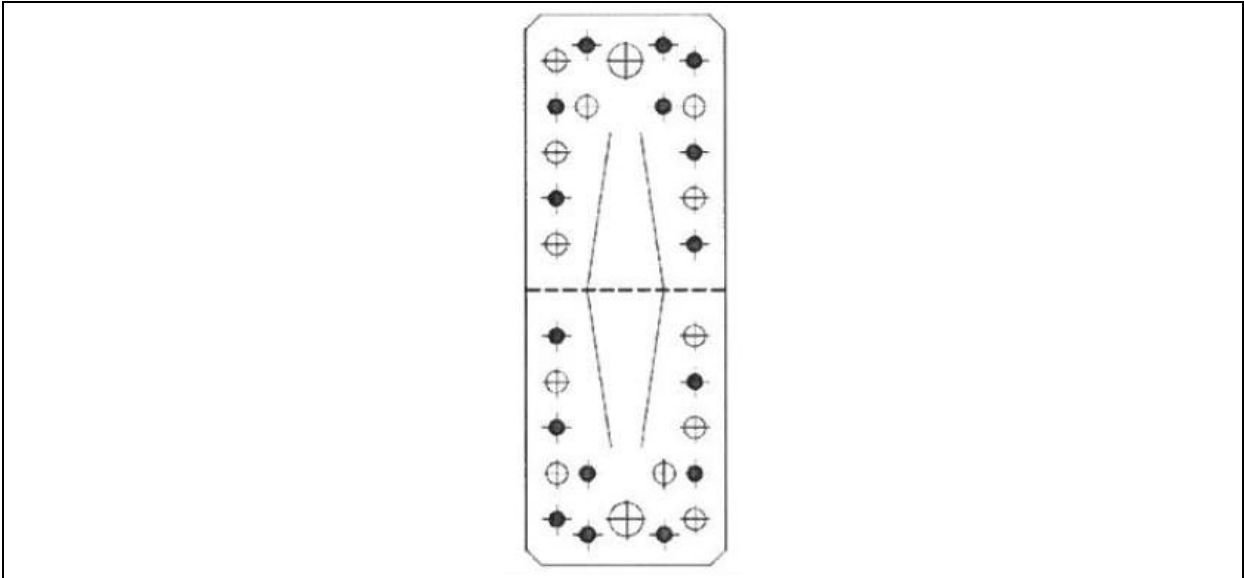

Figure 149 Type KP 1 and KPL 1

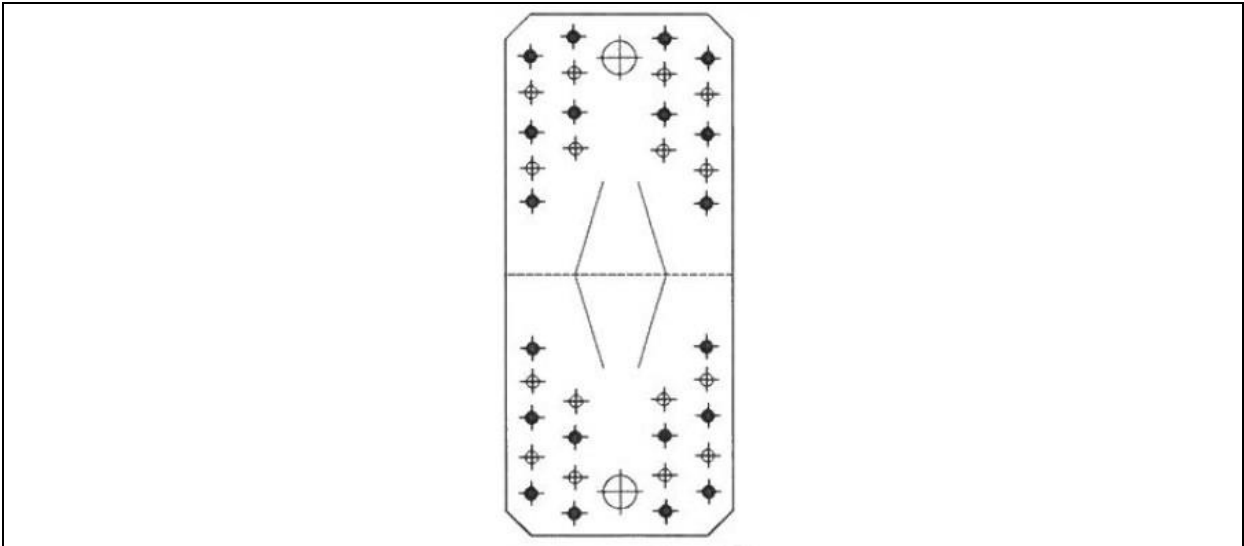

Figure 150 Type KP 2 and KPL 2

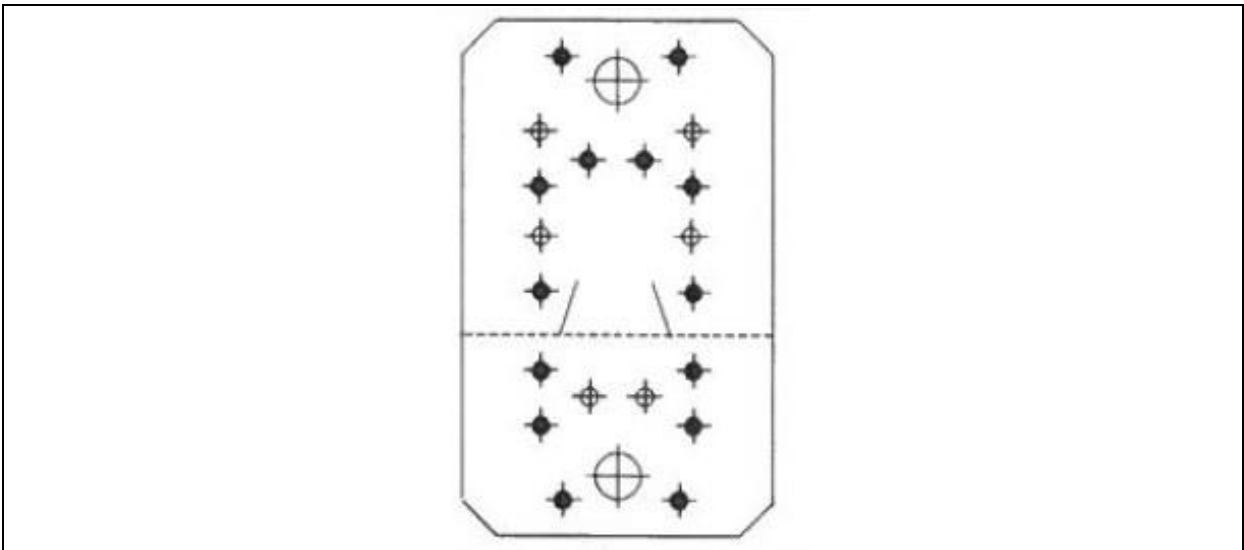

Figure 151 Type KP 3 and KPL 3

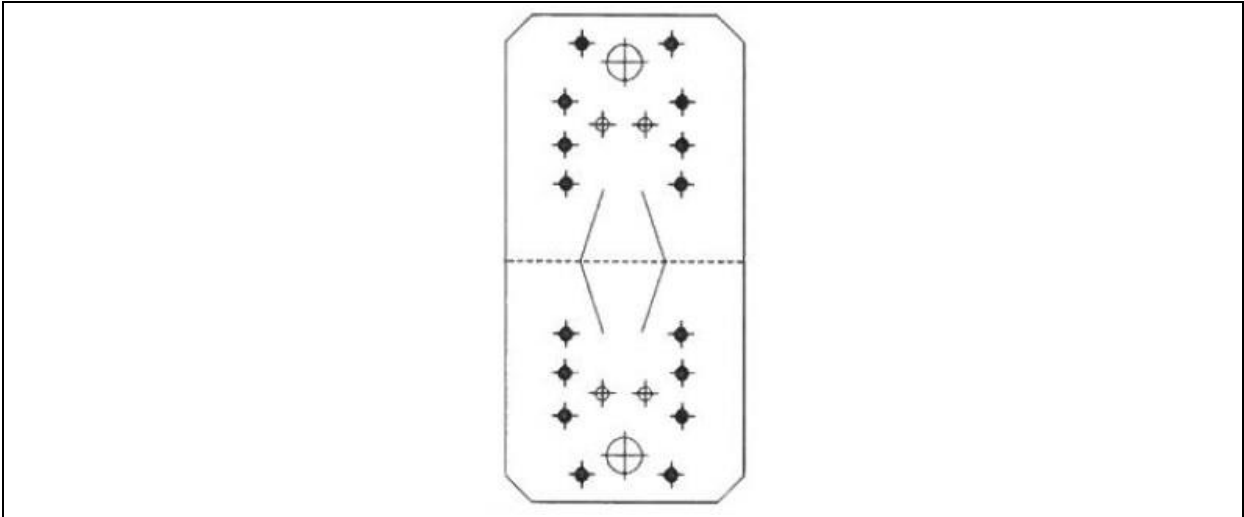

Figure 152 Type KP 4 and KPL 4

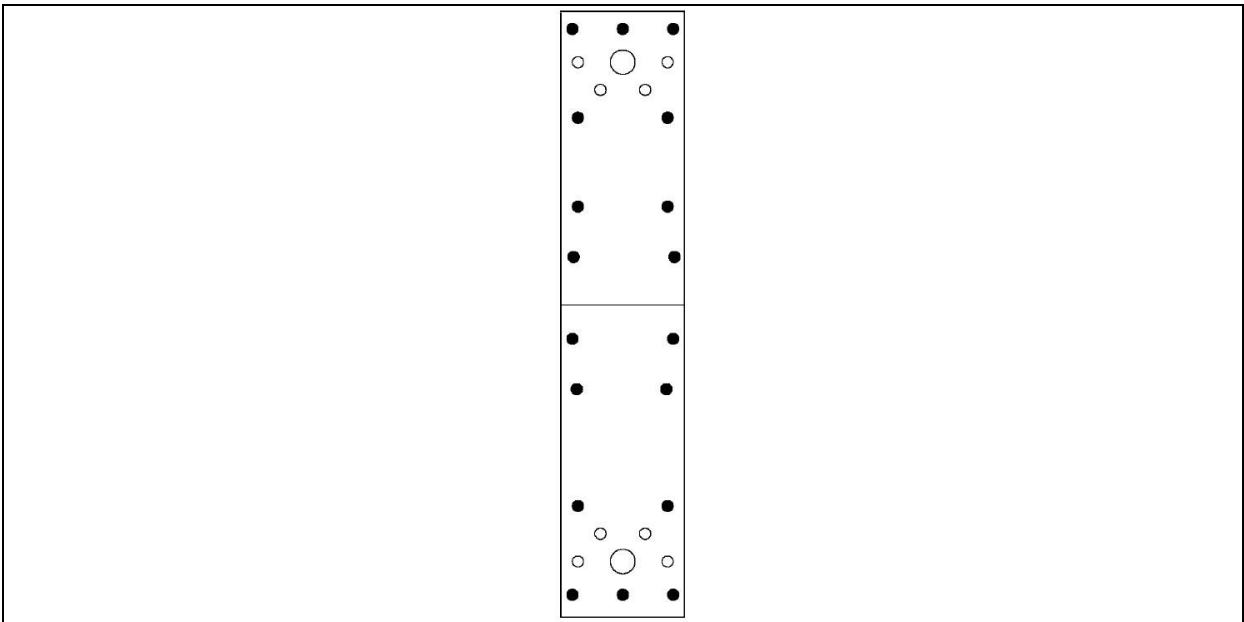

Figure 153 Type KP 5

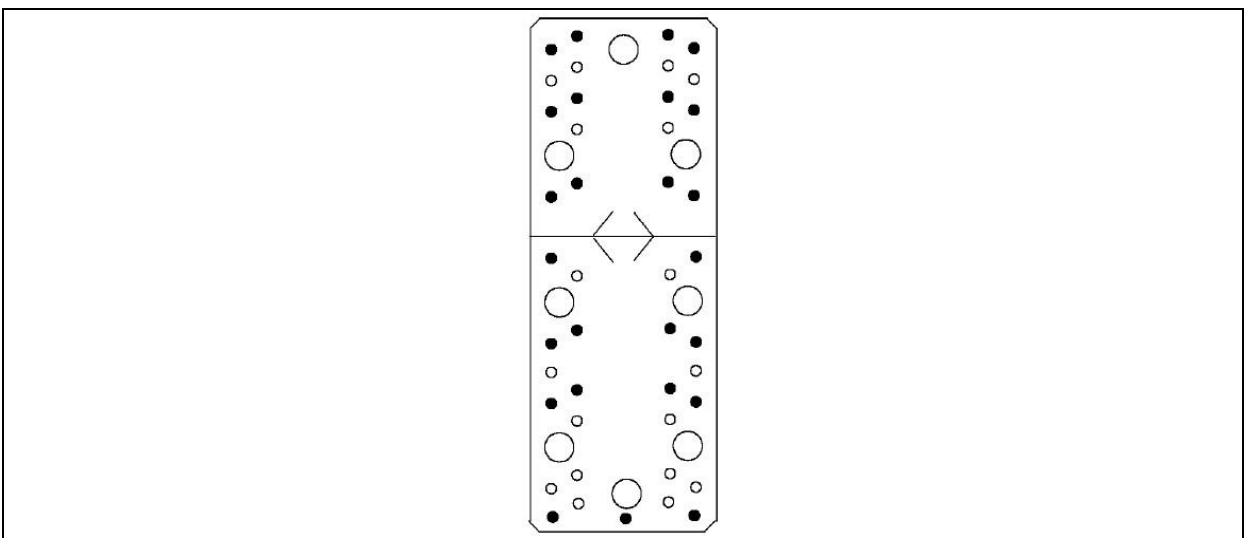

Figure 154 Type KP 6

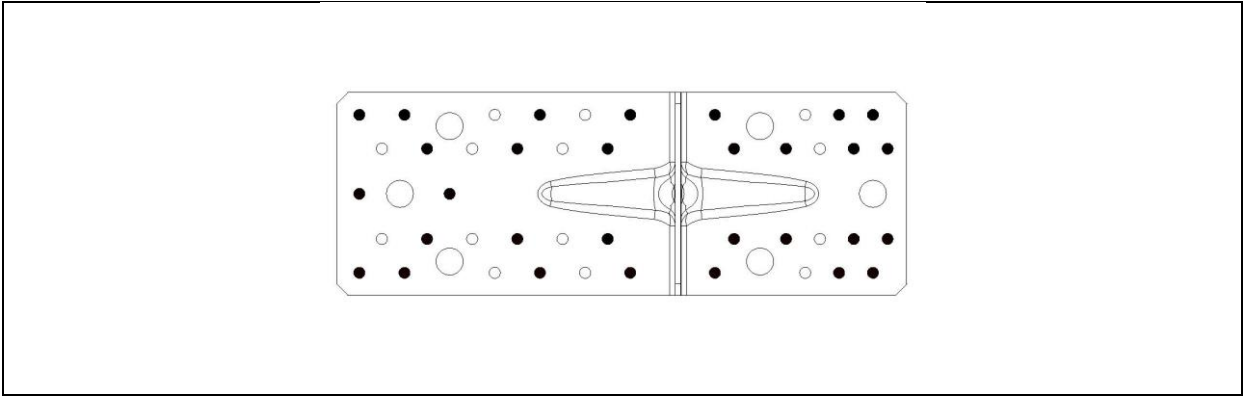

Figure 155 Type KP 10 and KPL 10

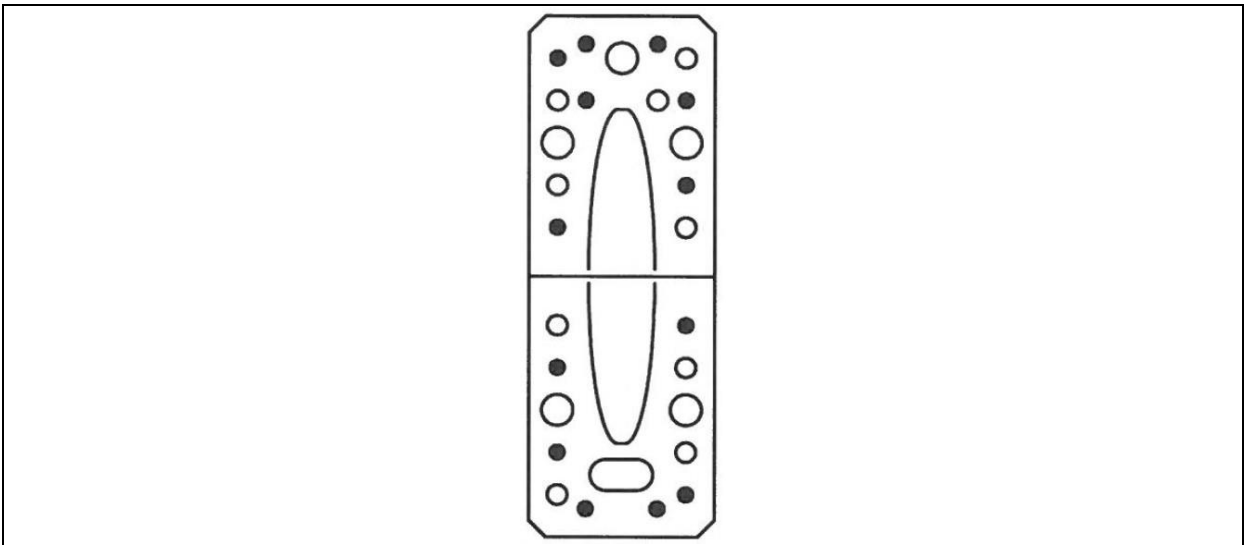

Figure 156 Type KP 11

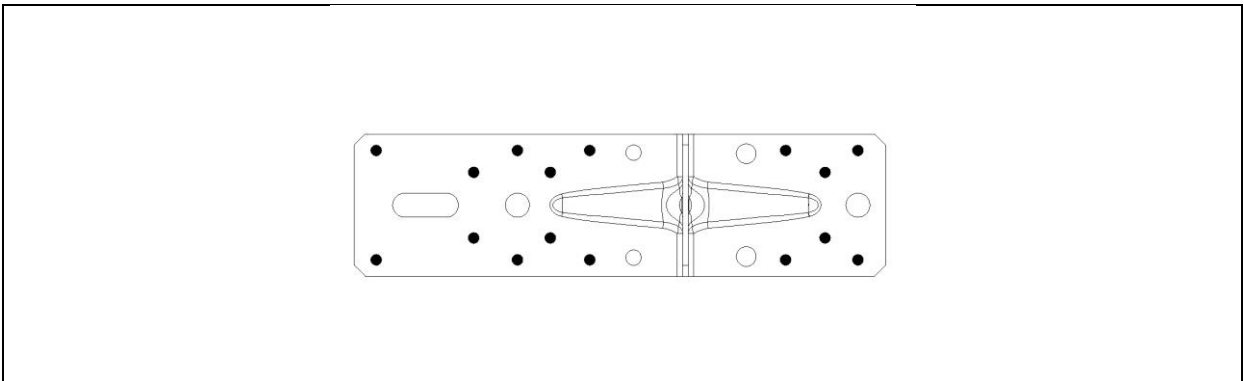

Figure 157 Type KP 12 and KPL 12

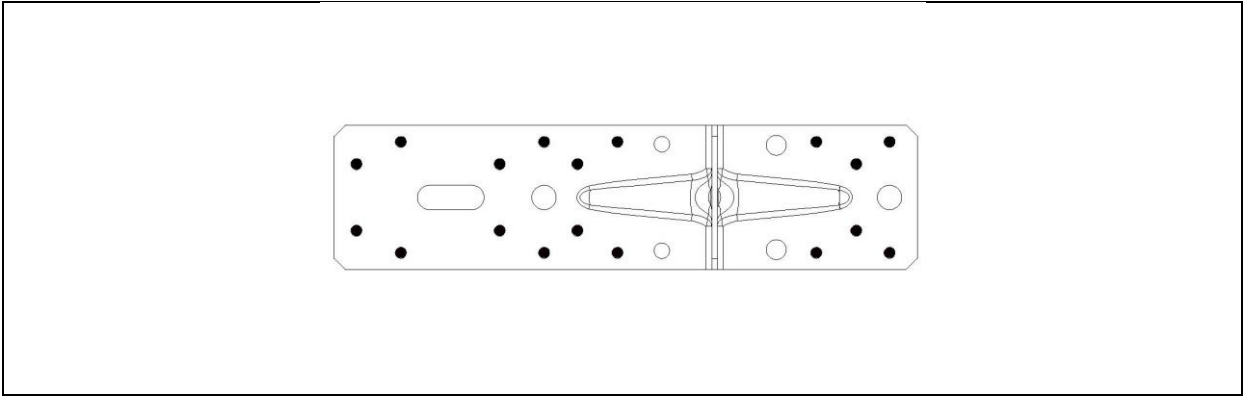

Figure 158 Type KP 13

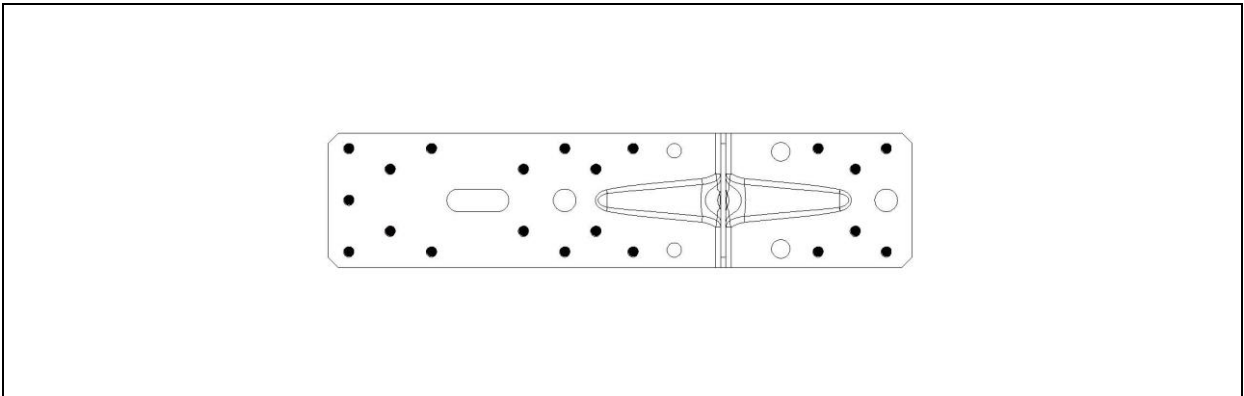

Figure 159 Type KP 14

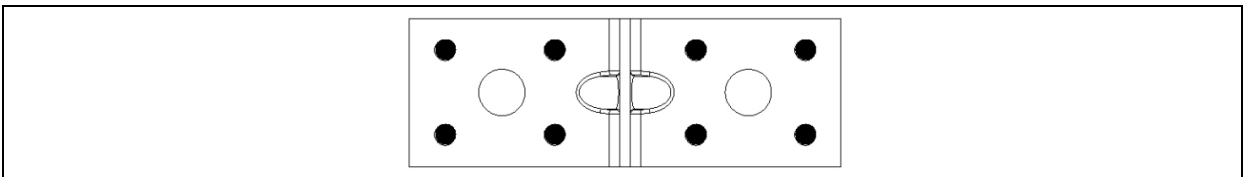

Figure 160 Type KP 15

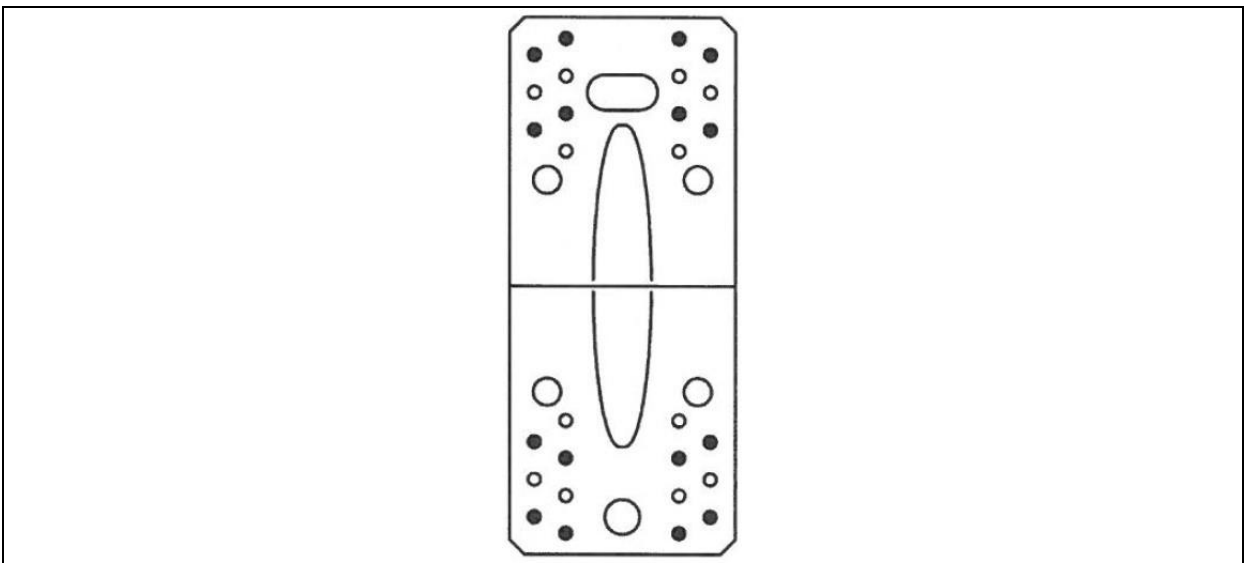

Figure 161 Type KP 21

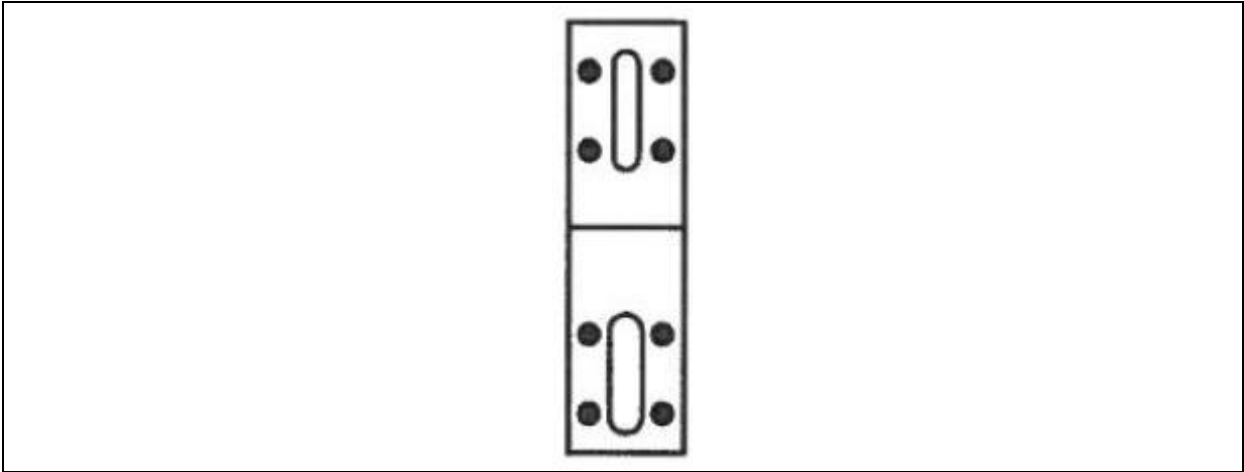

Figure 162 Type KRD 1

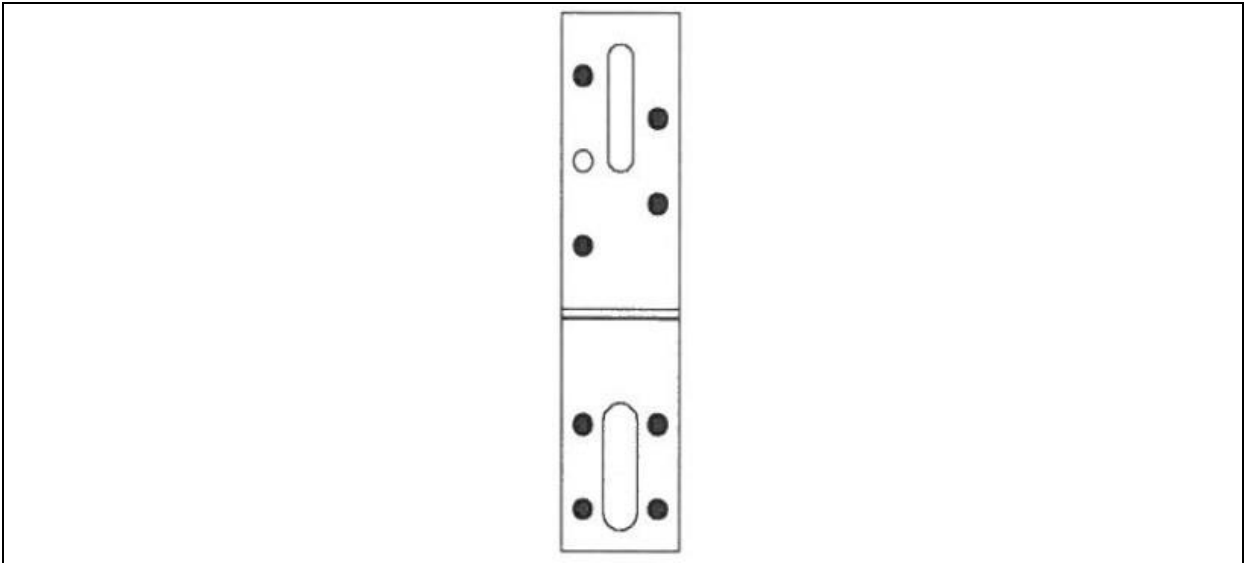

Figure 163 Type KRD 2

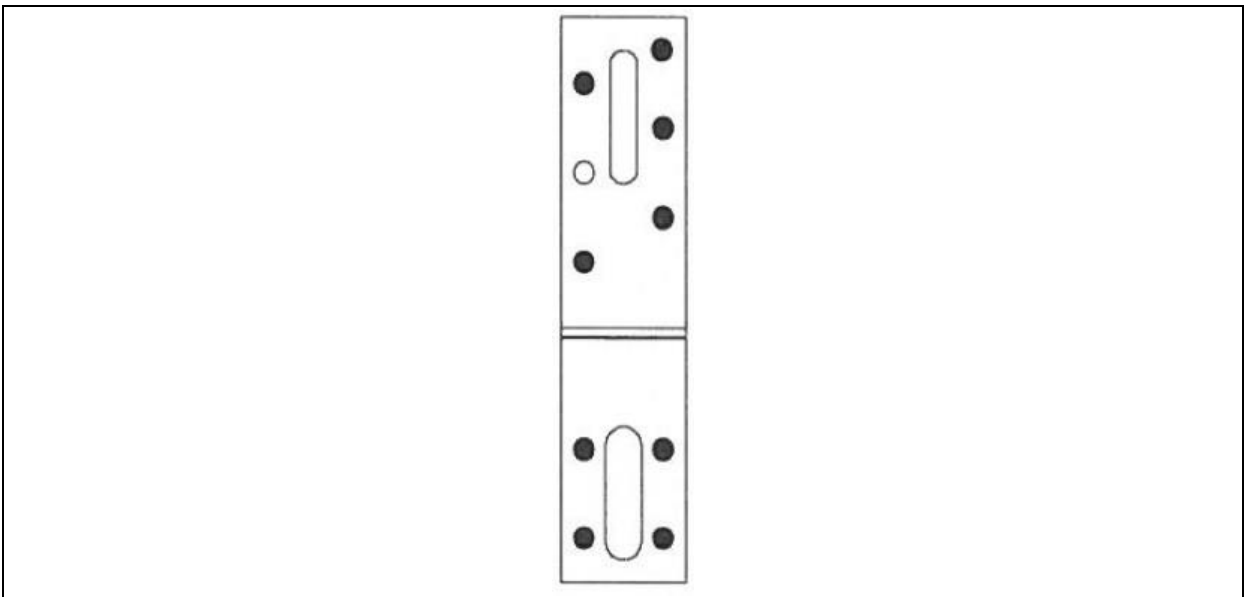

Figure 164 Type KRD 3 and KRD 4

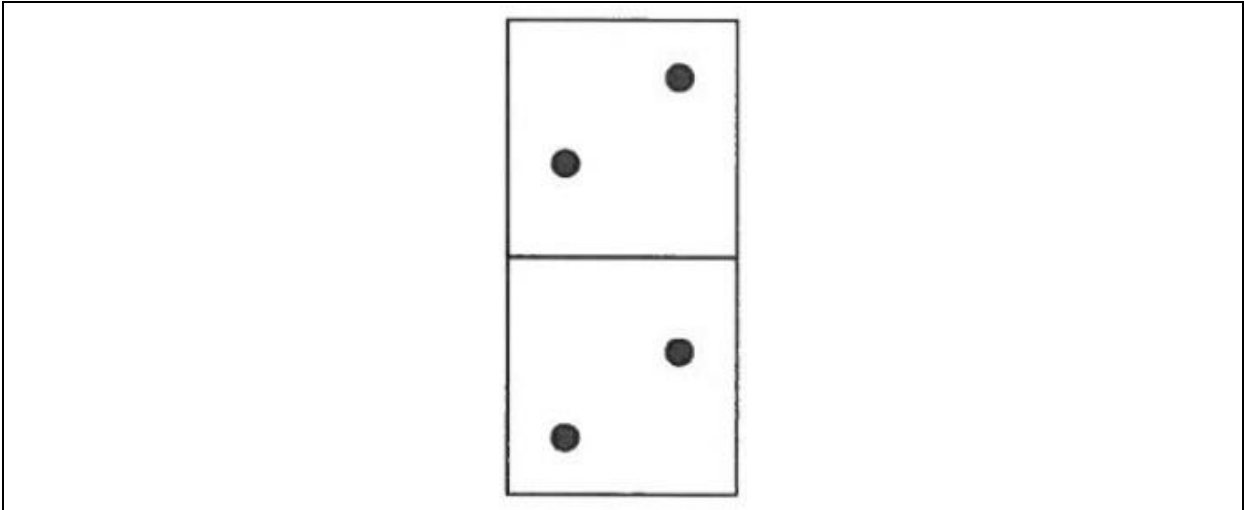

Figure 165 Type KS 1, KS 2, KSO 1 and KSO 2

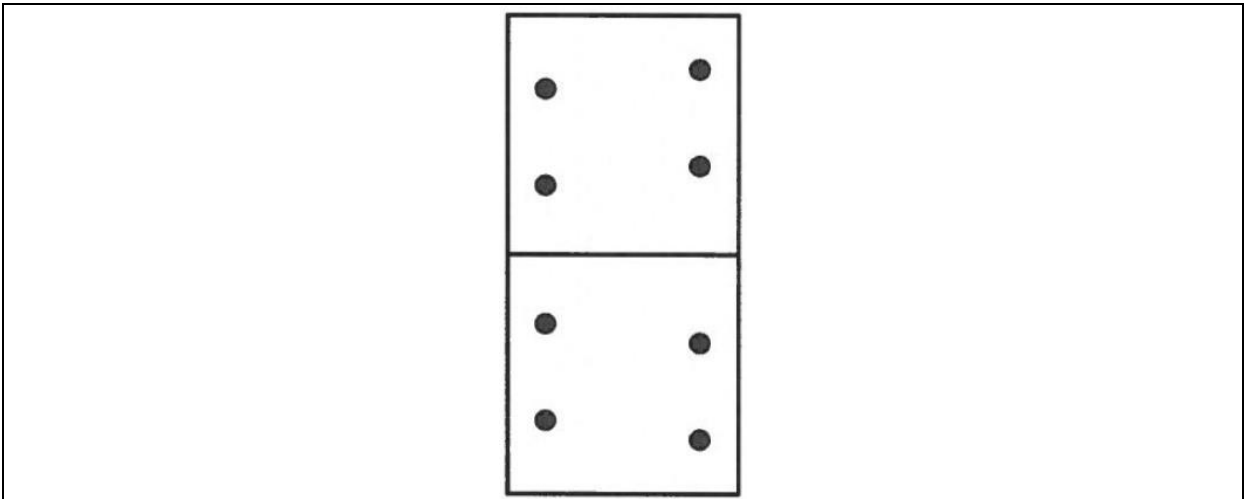

Figure 166 Type KS 3 and KSO 3

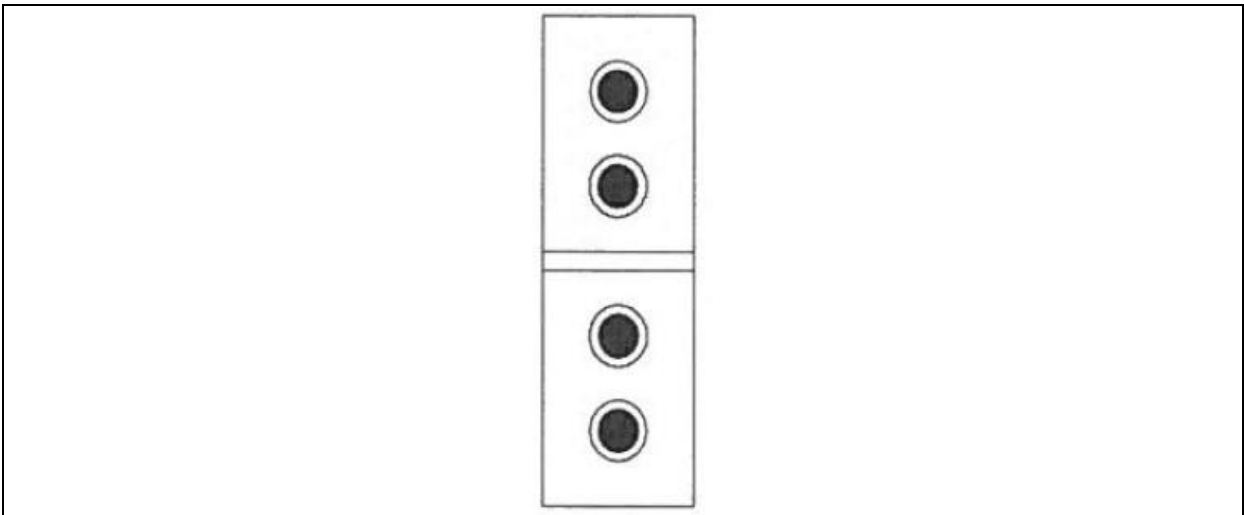

Figure 167 Type KW 1, KW 2, KW 3, KW 4, KW 5, KW 6, KW 7, KWO 1, KWO 2, KWO 3, KWO 4

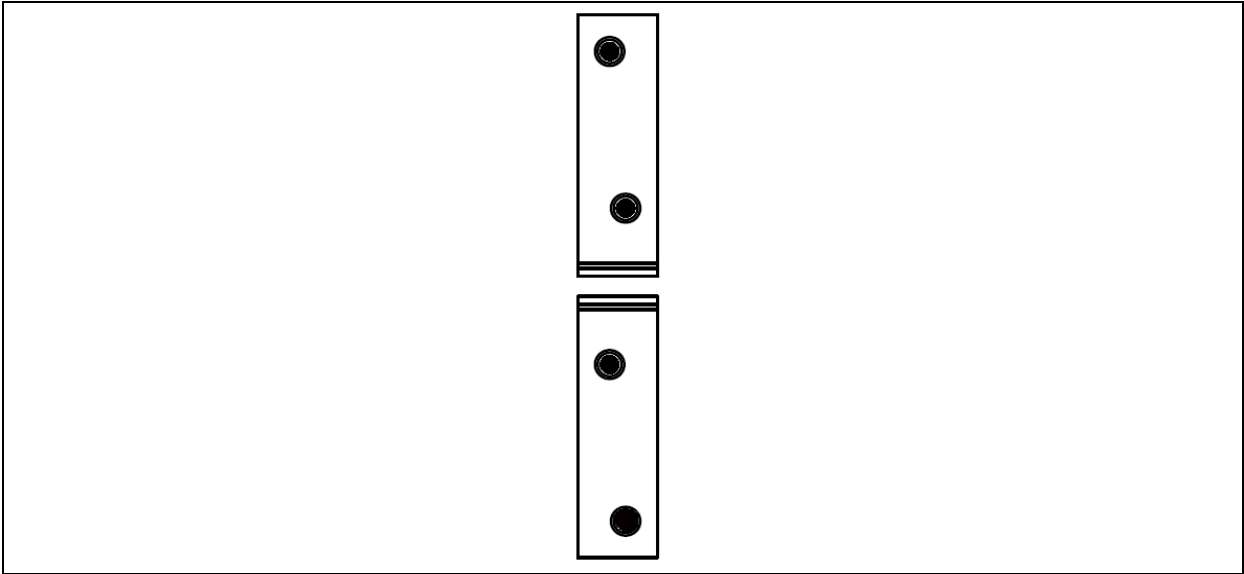

Figure 168 Type KW 25, KW 30, KW 40, KW 50 and KW 60

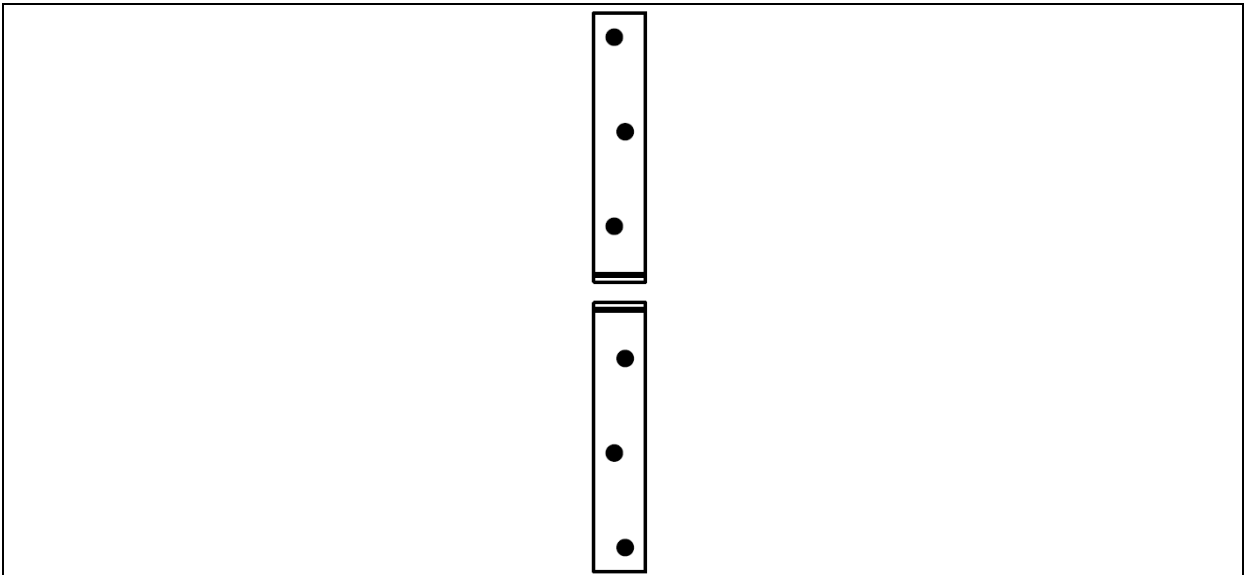

Figure 169 Type KW 80, KW 100, KW 125, KW 150

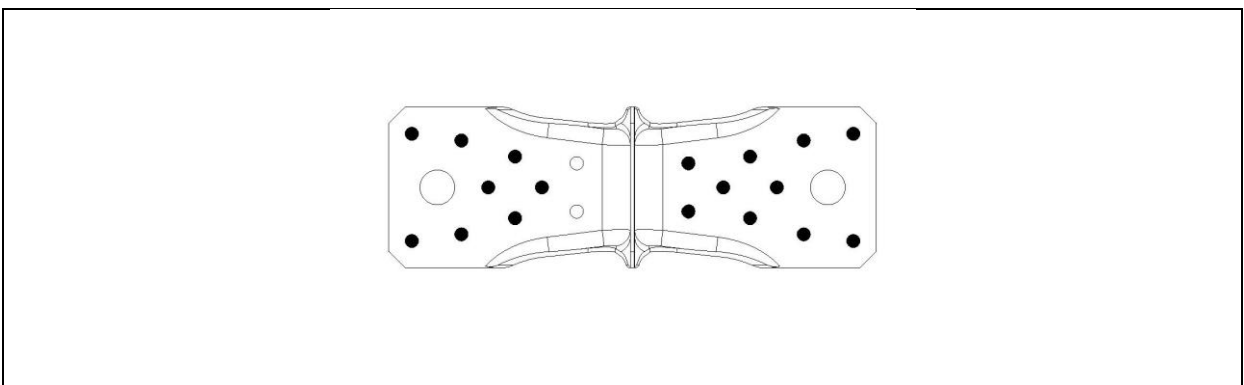

Figure 170 Type LBS 90

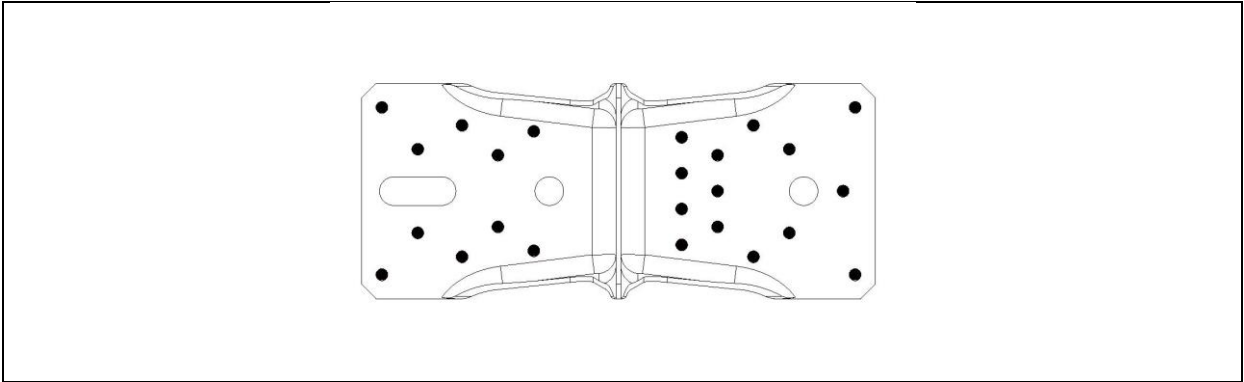

Figure 171 Type LBS 105

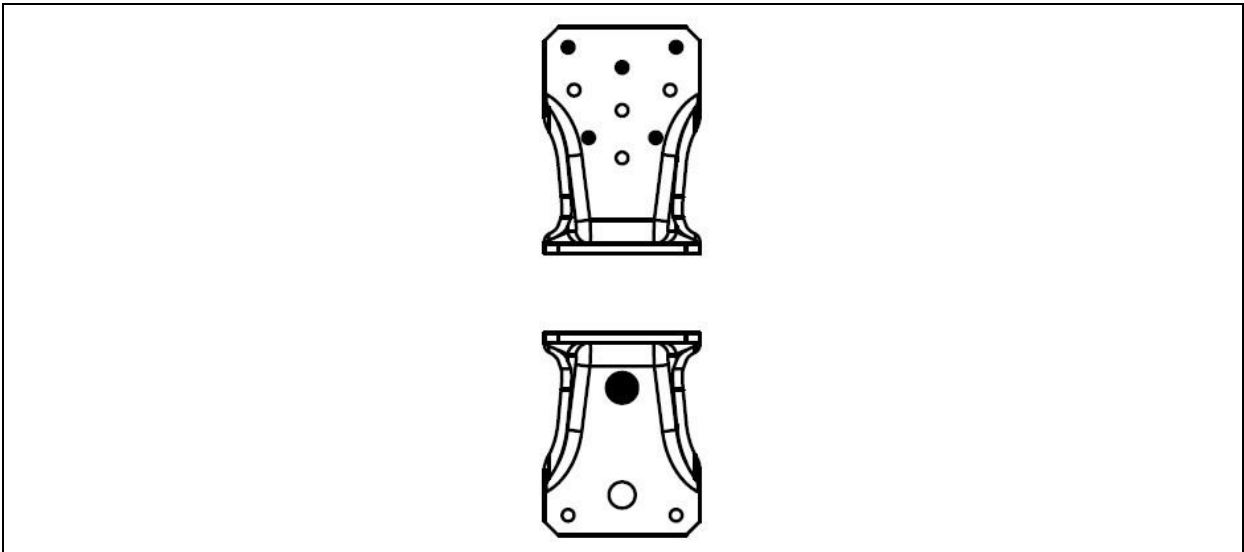

Figure 172 Type LBZ 95

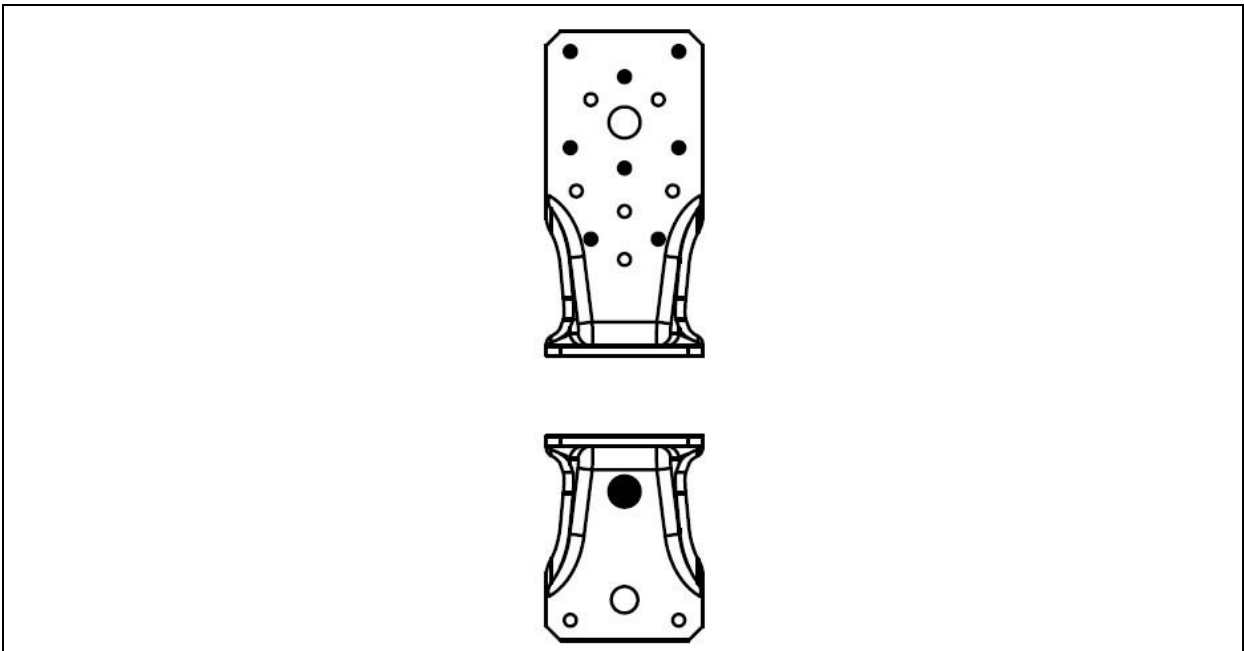

Figure 173 Type LBZ 135

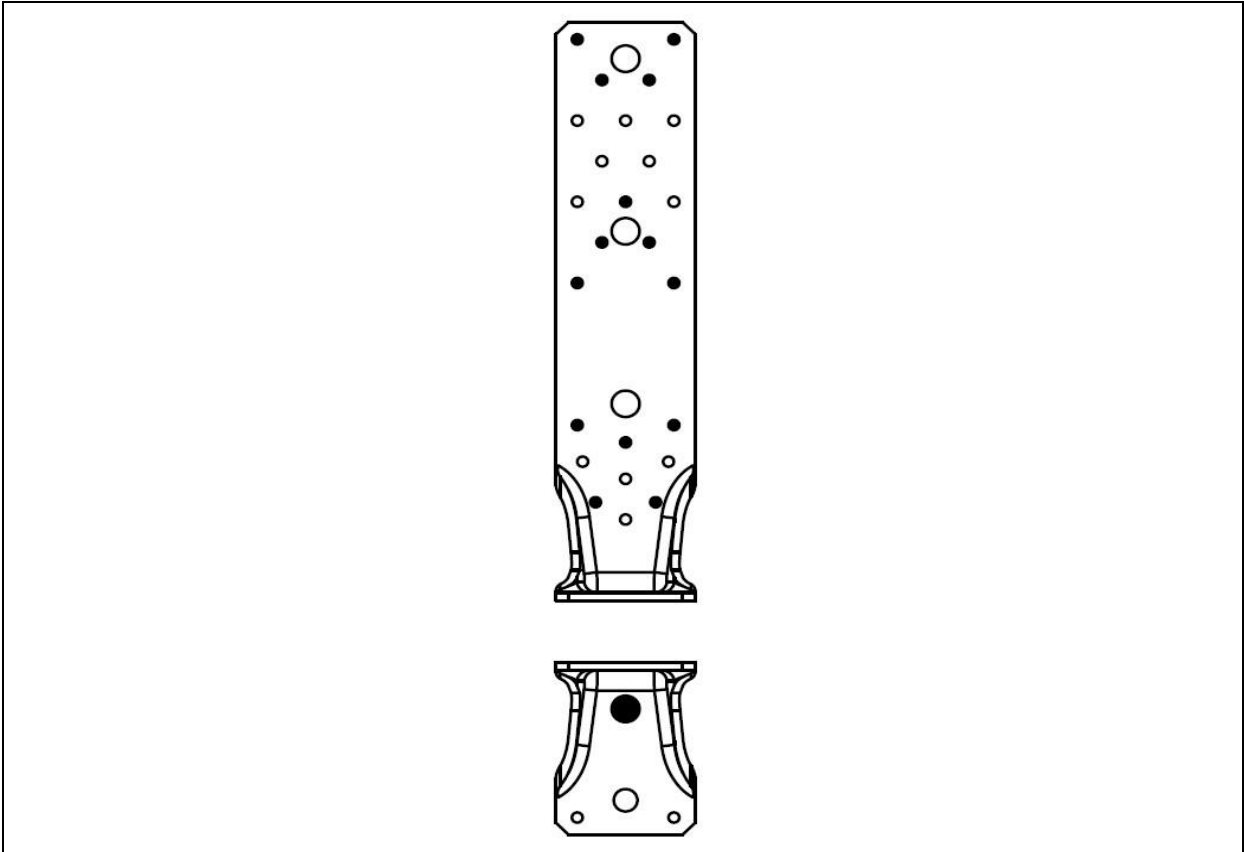

Figure 174 Type LBZ 285

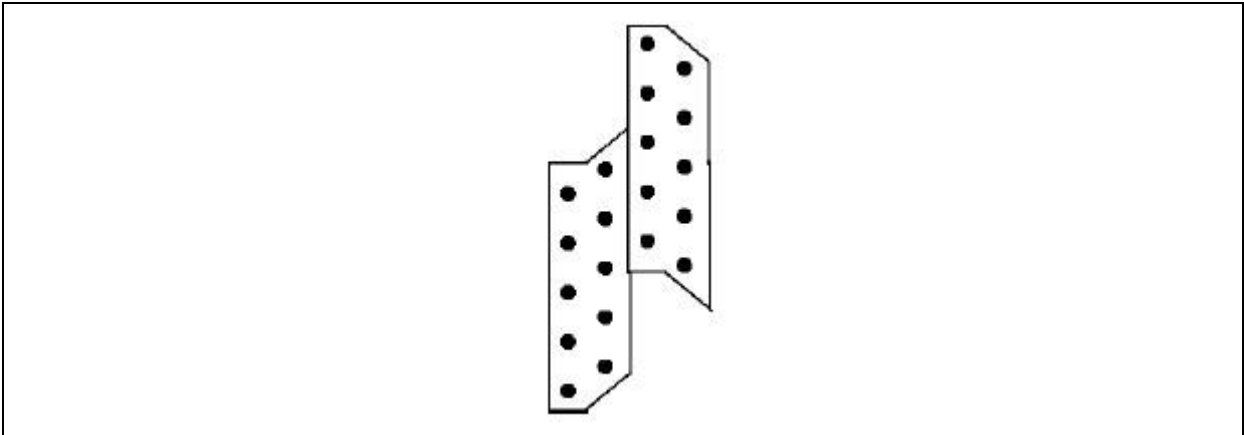

Figure 175 Type LK 1

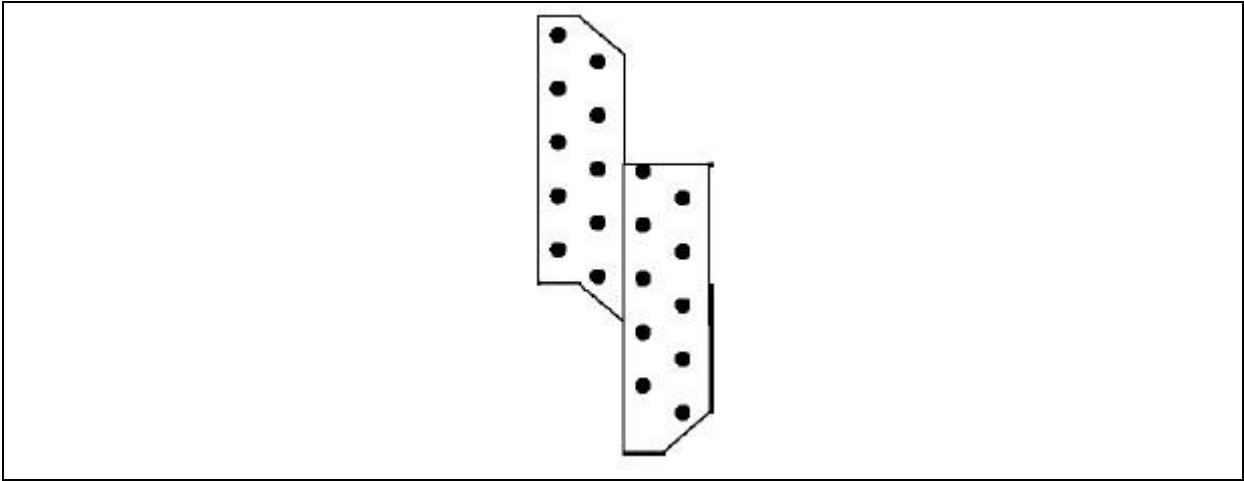

Figure 176 Type LK 2

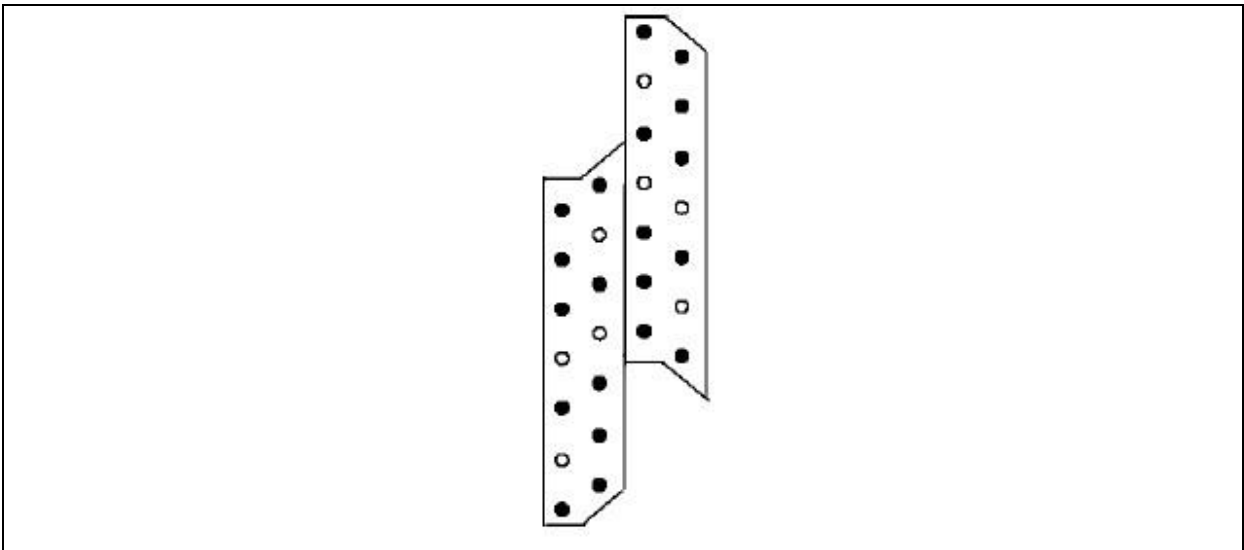

Figure 177 Type LK 3

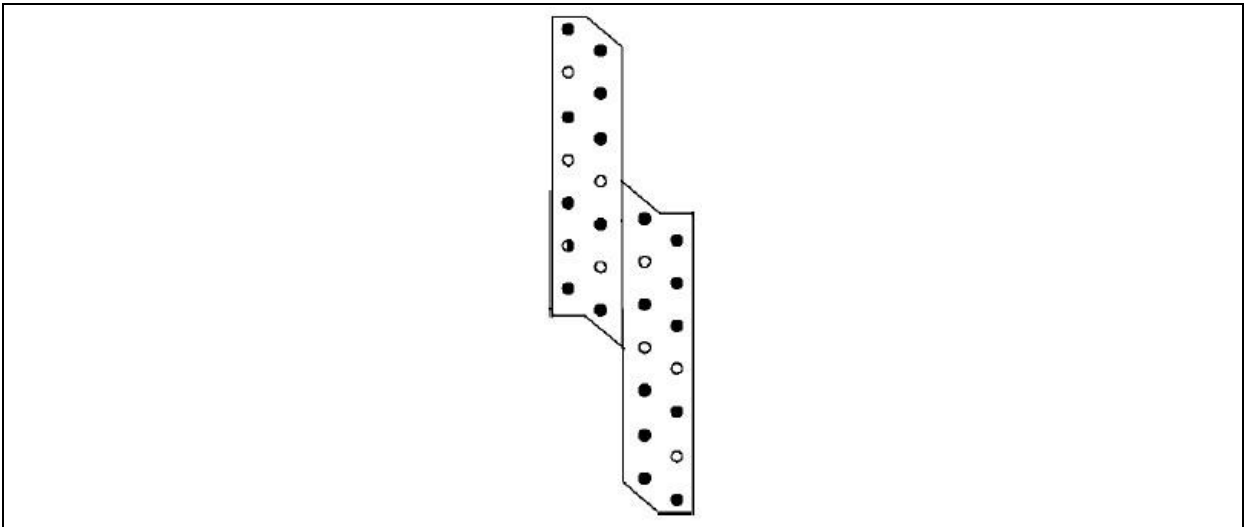

Figure 178 Type LK 4

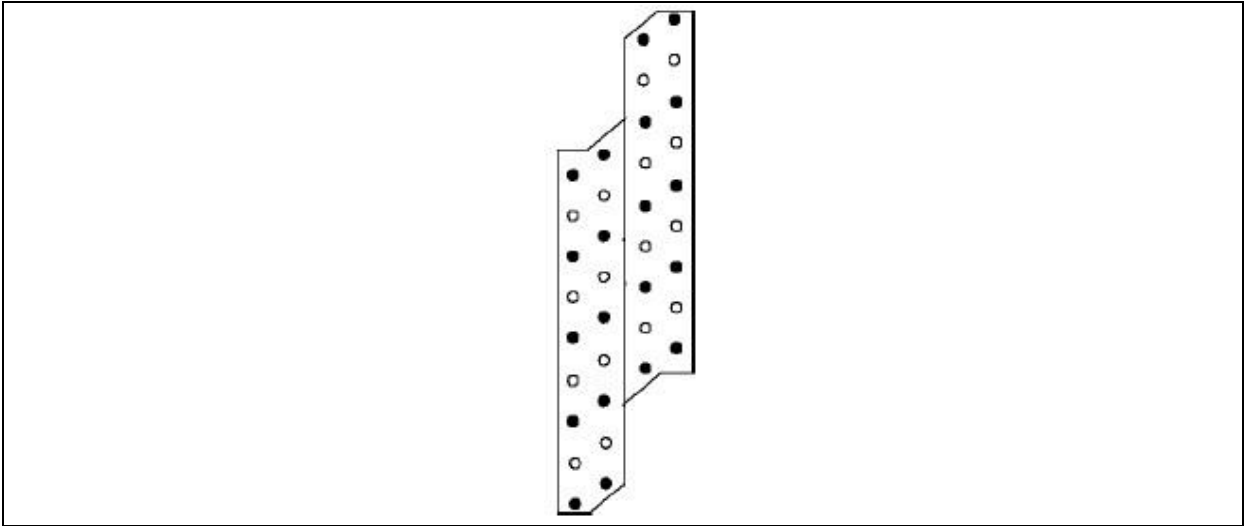

Figure 179 Type LK 5

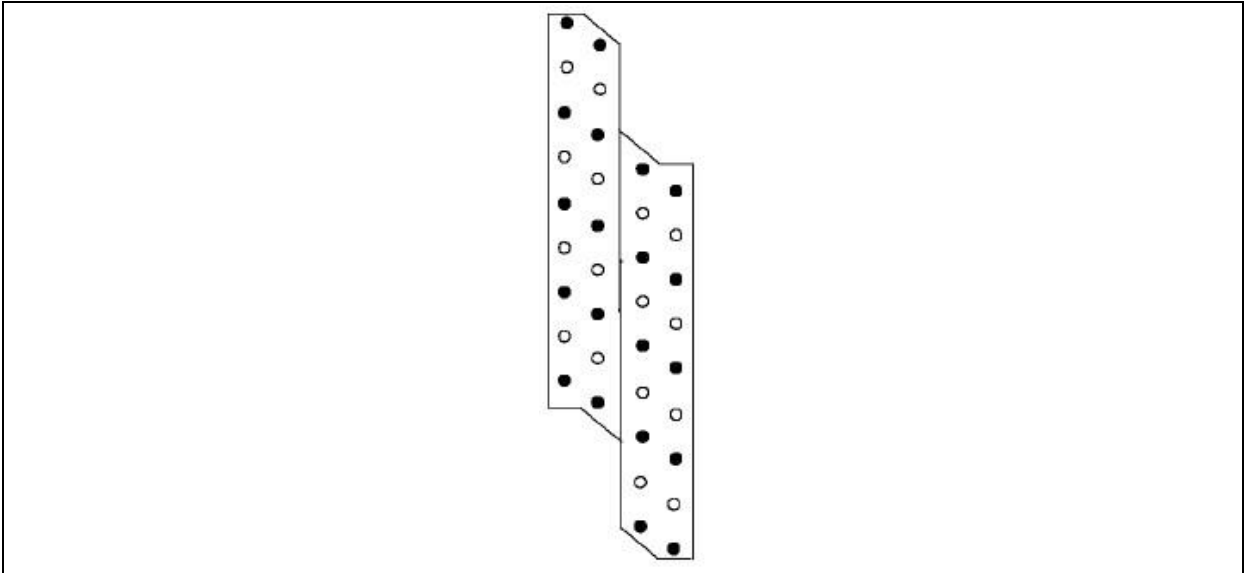

Figure 180 Type LK 6

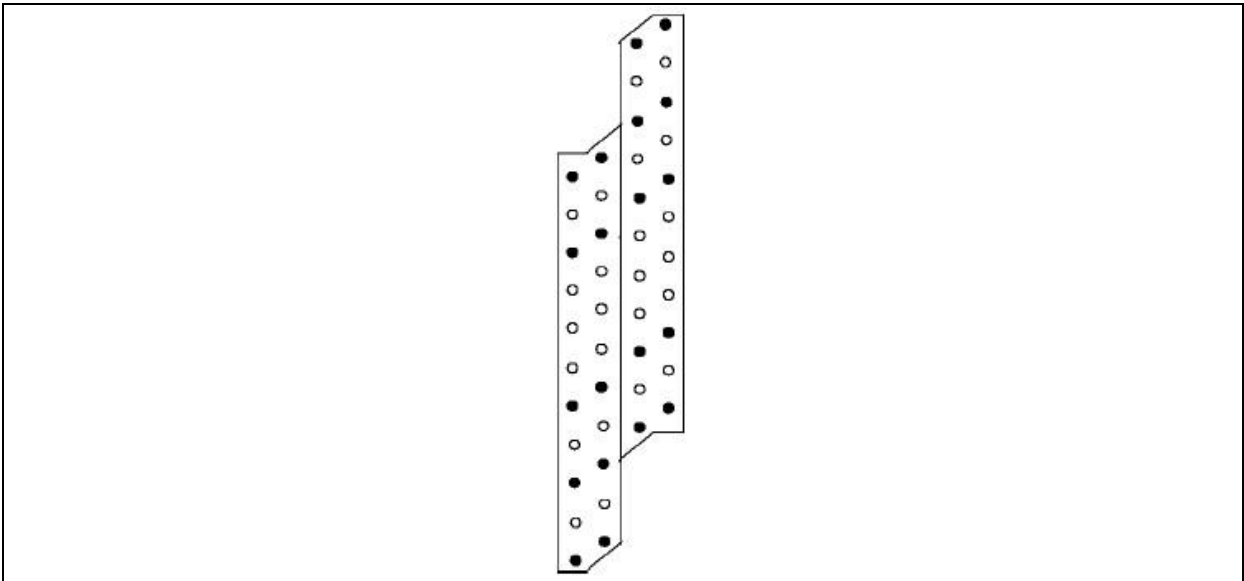

Figure 181 Type LK 7

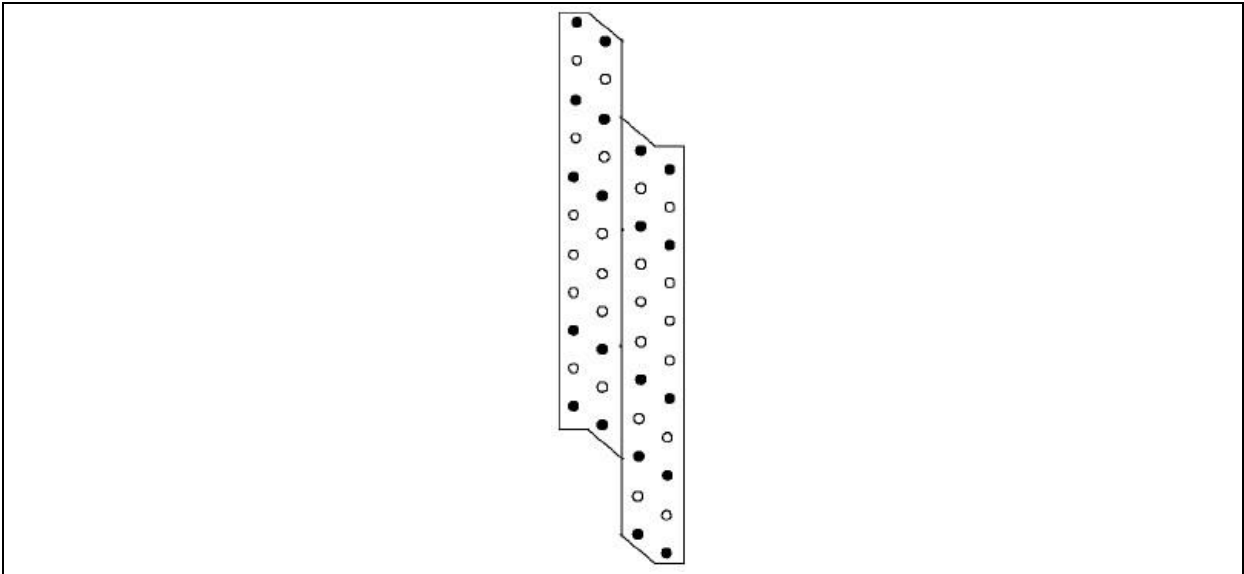

Figure 182 Type LK 8

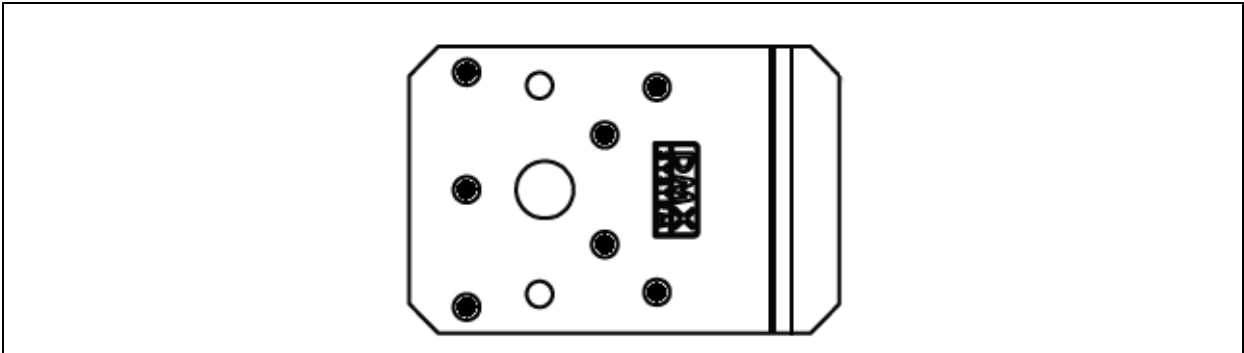

Figure 183 Type LZ 0

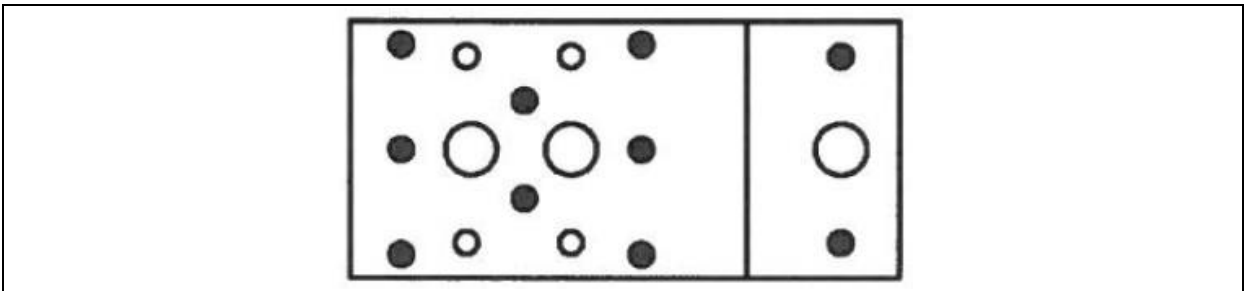

Figure 184 Type LZ 1, LZ 2 and LZ 3

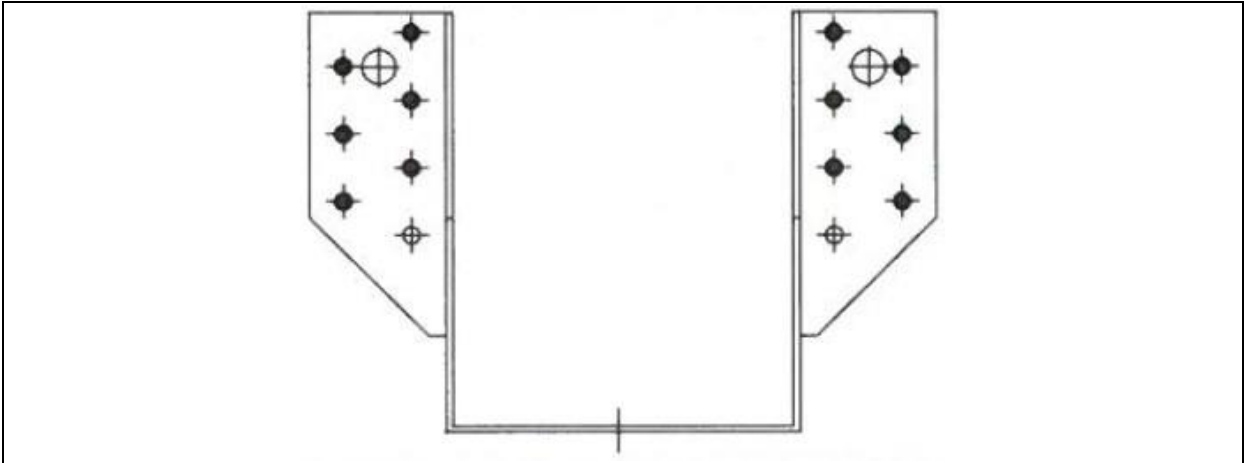
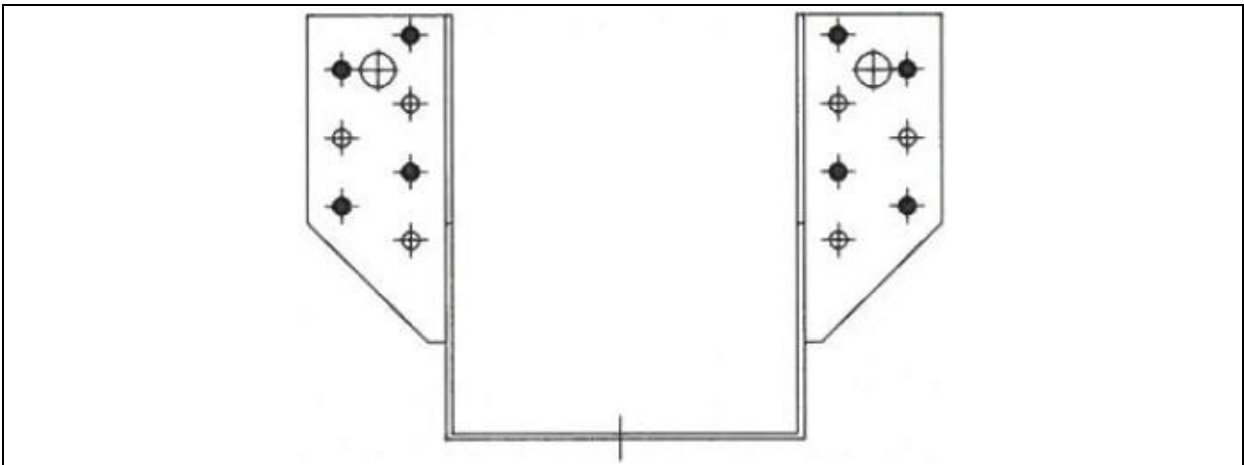

Figure 185 Type WB 1, WB 2, WB 5, WB 8, WB 10, WB 14, WB 19



* Incomplete nailing

Figure 186 Type WB 1, WB 2, WB 5, WB 8, WB 10, WB 14, WB 19

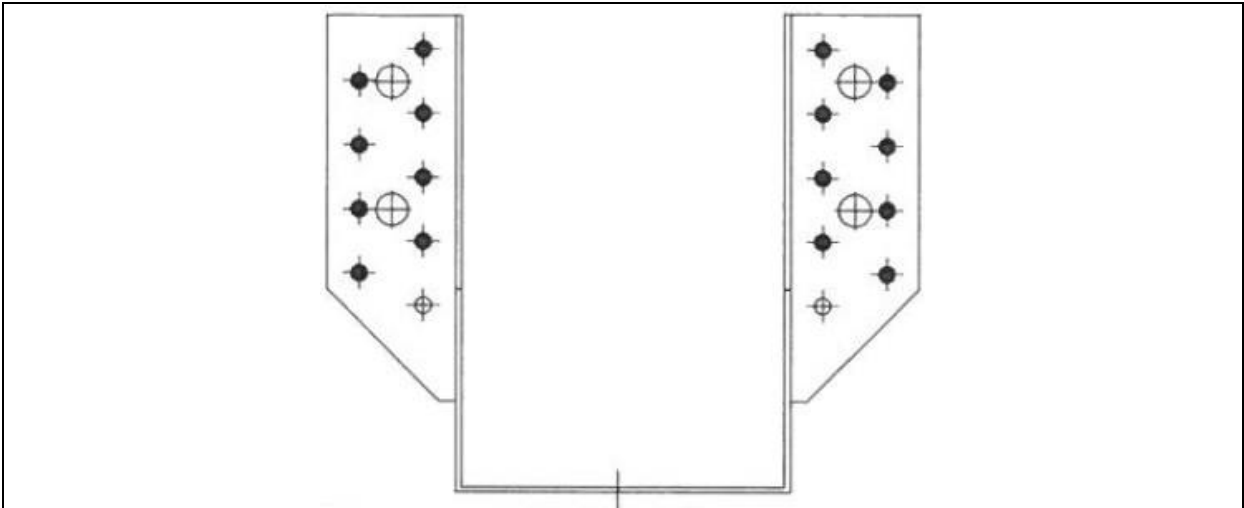

Figure 187 Type WB 3, WB 6, WB 9, WB 11, WB 15, WB 20, WB 21, WB 23, WB 26

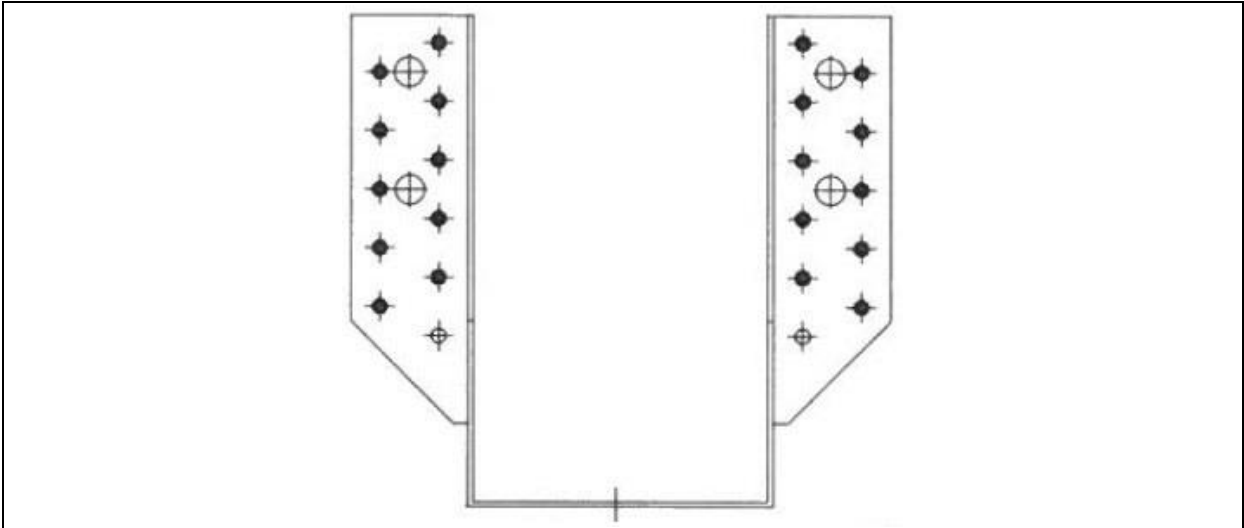

Figure 188 Type WB 4, WB 7, WB 12, WB 16, WB 22, WB 24, WB 27, WB 30

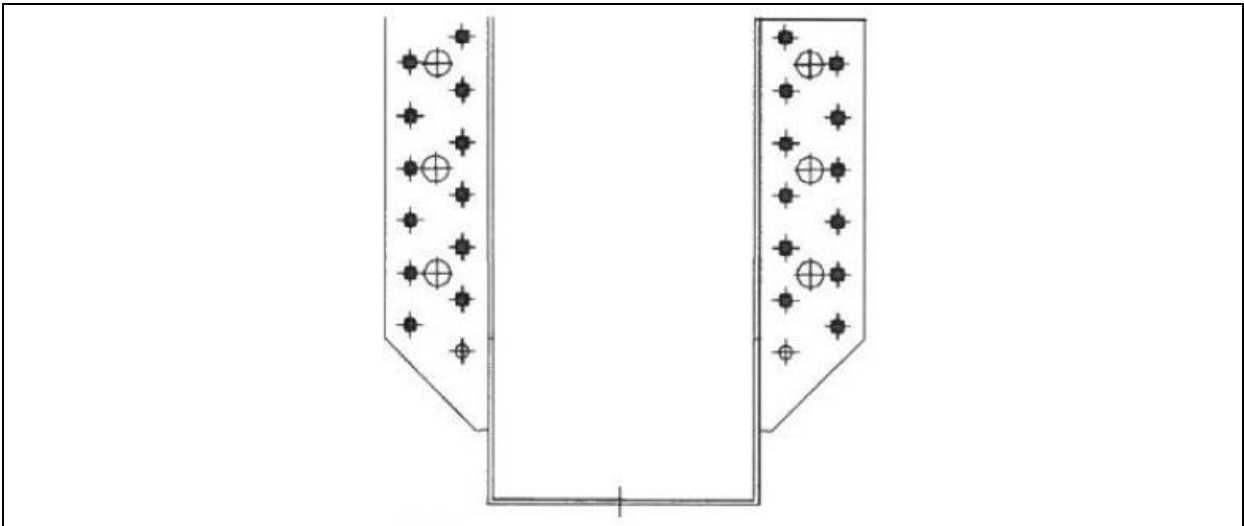

Figure 189 Type WB 13, WB 17, WB 25, WB 28, WB 31, WB 33, WB 35

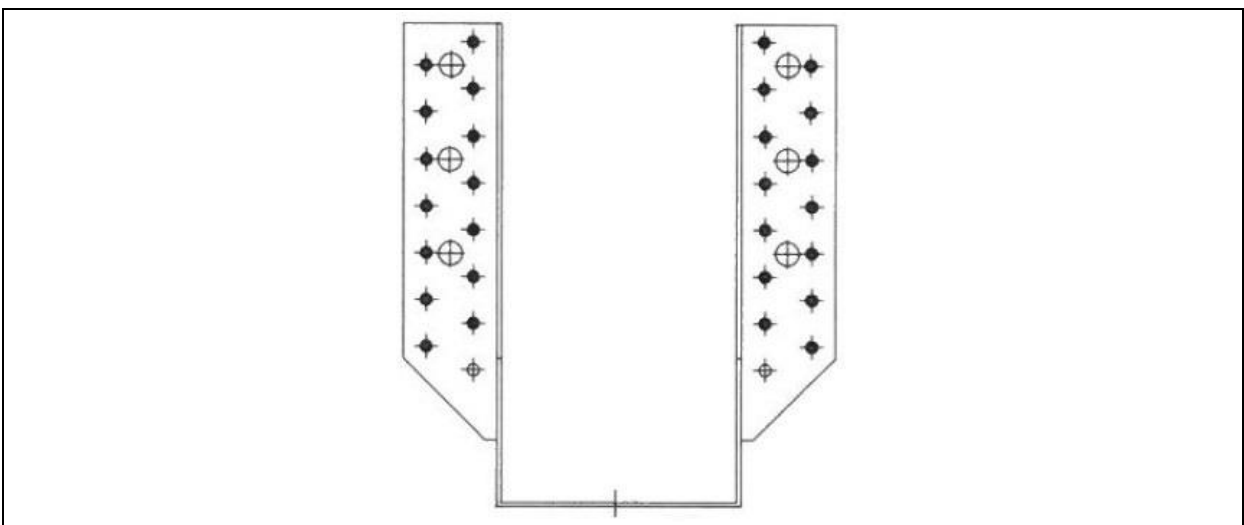

Figure 190 Type WB 18, WB 29, WB 32, WB 34, WB 36, WB 37, WB 38

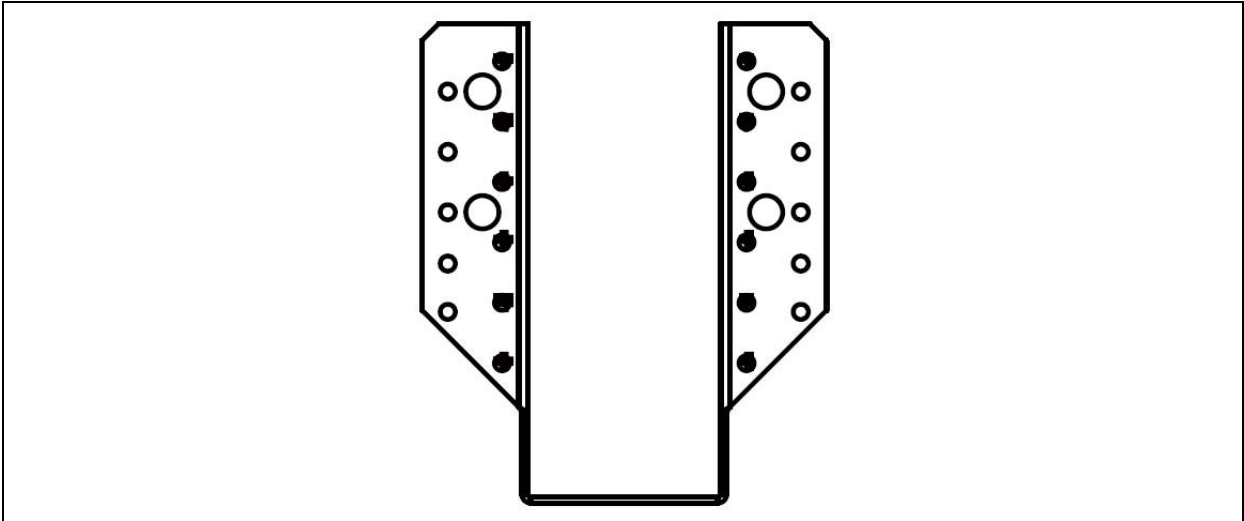

Figure 191 Type WB 64

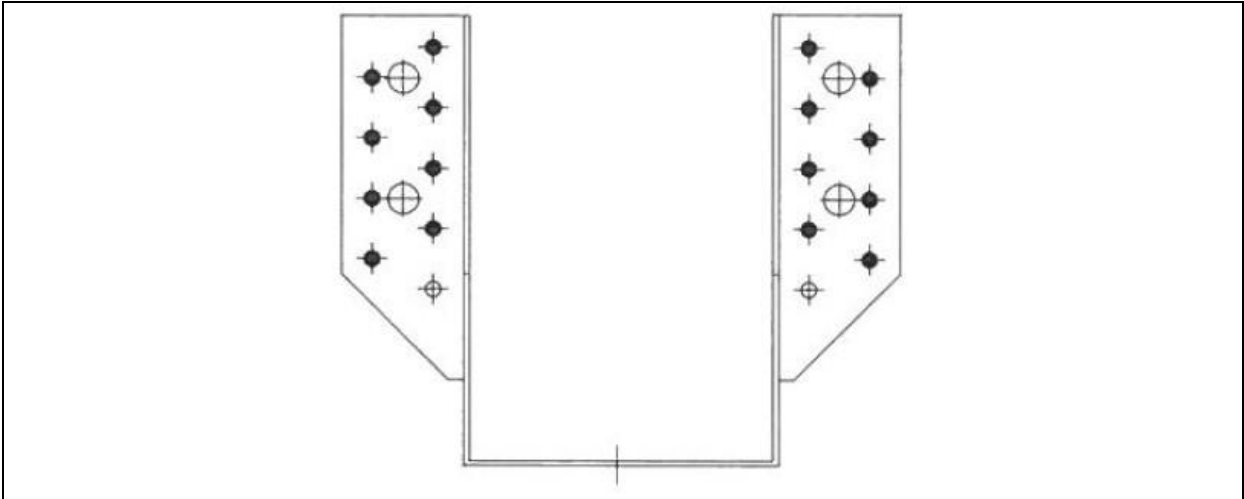

Figure 192 Type WBD 105 L, WBD 105 P, WBD 130 L, WBD 130 P, WBD 140 L, WBD 140 P, WBD 170 L, WBD 170 P, WBD 200 L, WBD 200 P

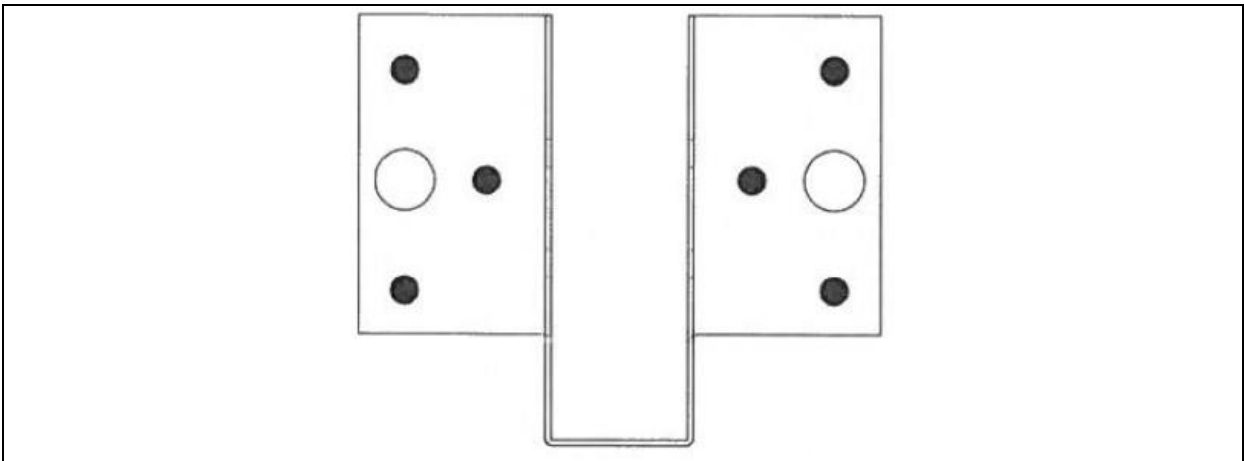

Figure 193 Type WL 5, WL 6, WL 7, WL 8, WL 9

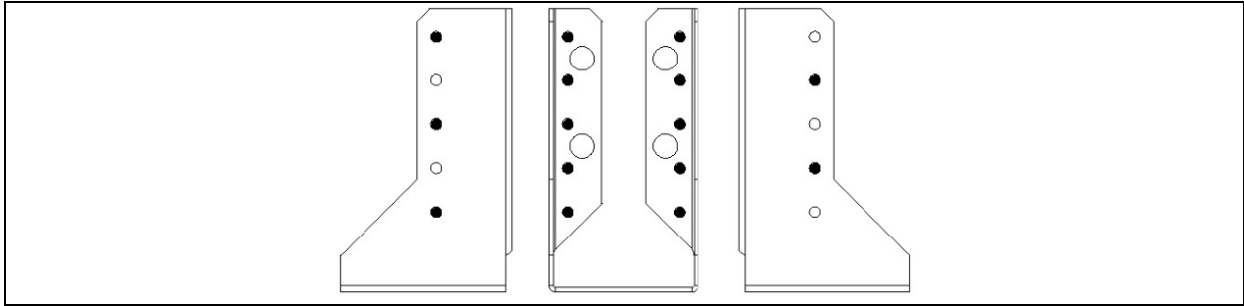

Figure 194 Type WBZ 20

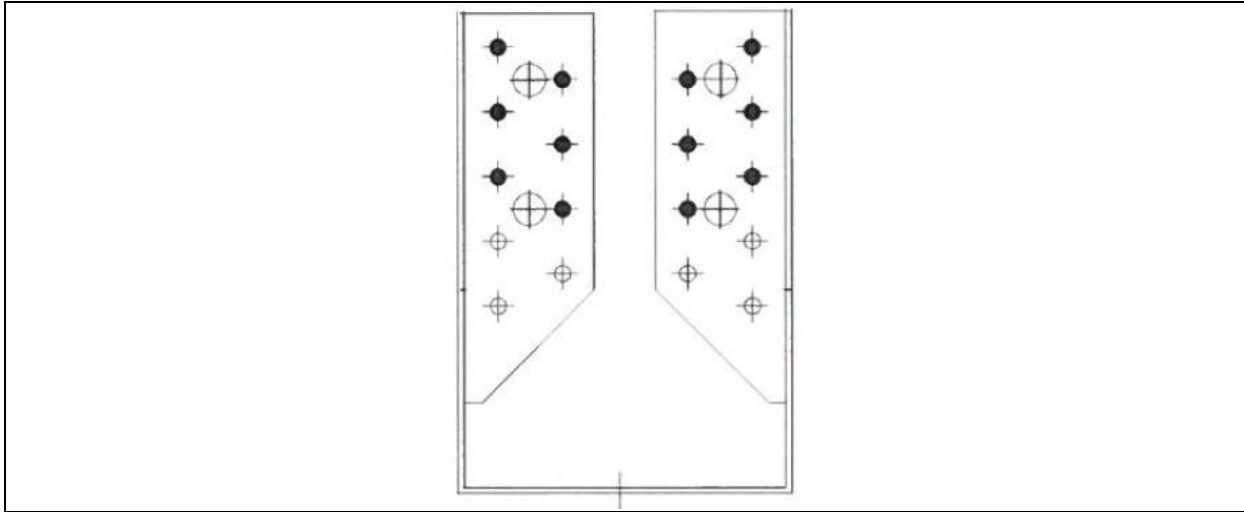
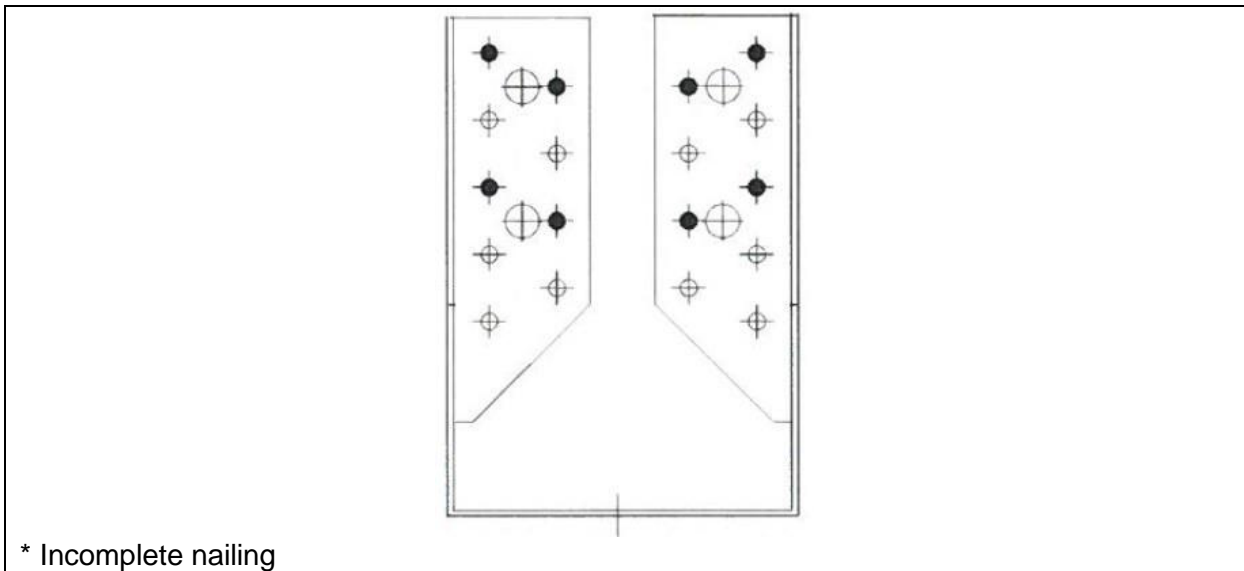

Figure 195 Type WBZ 21, WBZ 23, WBZ 26



* Incomplete nailing

Figure 196 Type WBZ 21, WBZ 23, WBZ 26

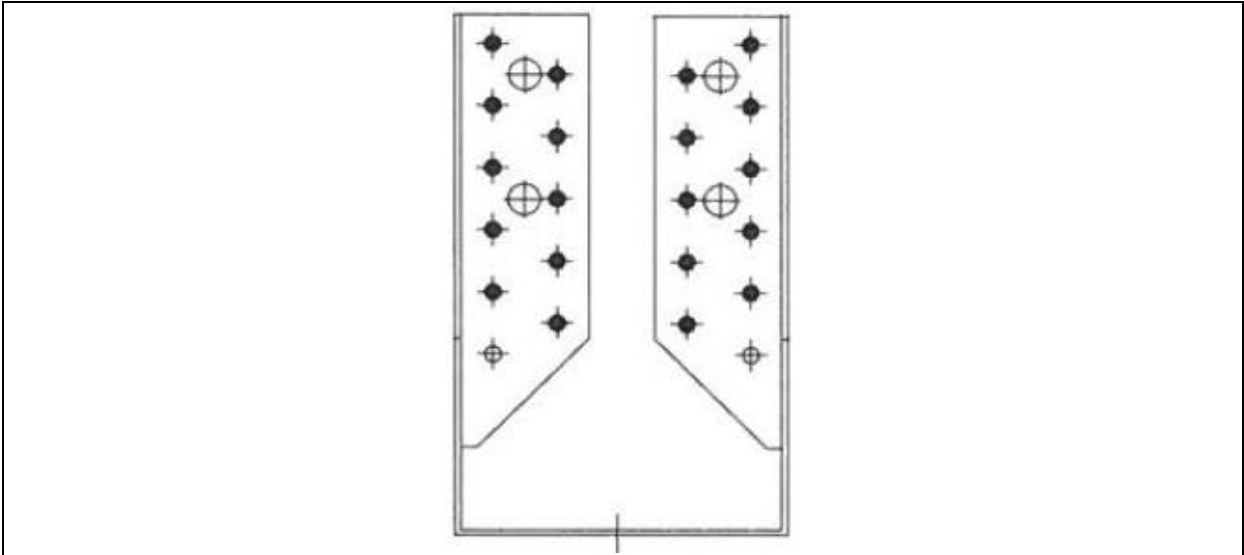

Figure 197 Type WBZ 22, WBZ 24, WBZ 27, WBZ 30

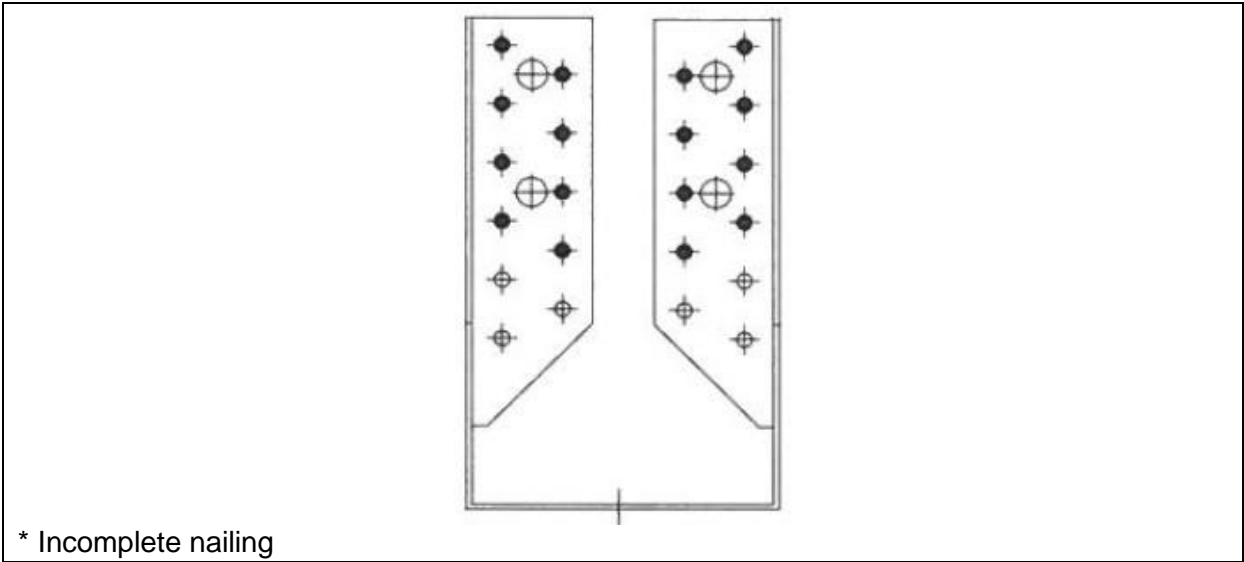

Figure 198 Type WBZ 22, WBZ 24, WBZ 27, WBZ 30

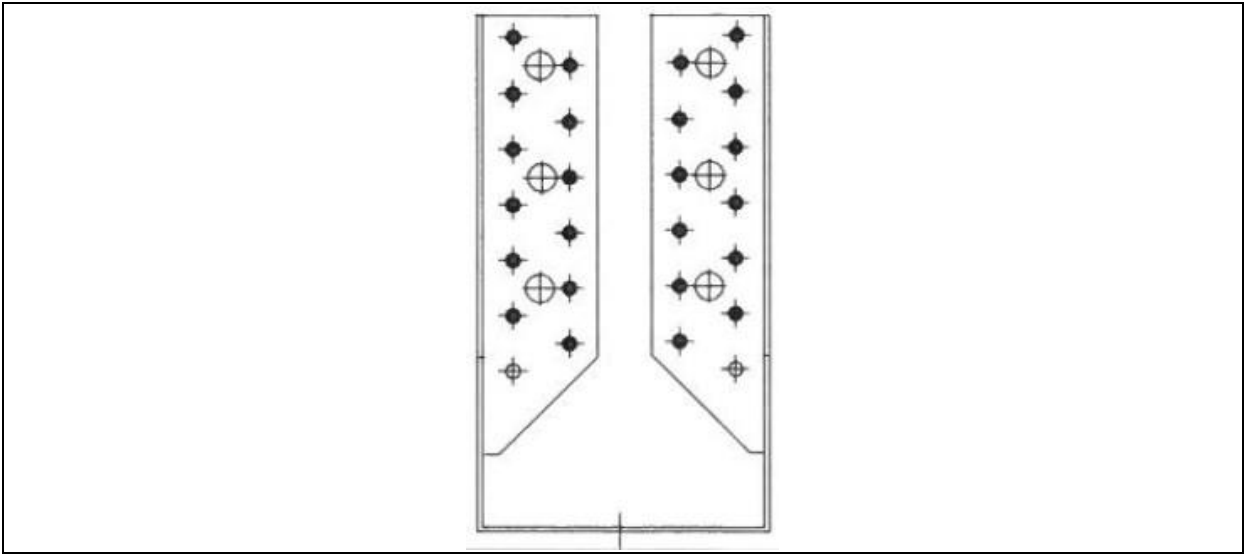

Figure 199 Type WBZ 25, WBZ 28, WBZ 31, WBZ 33, WBZ 35

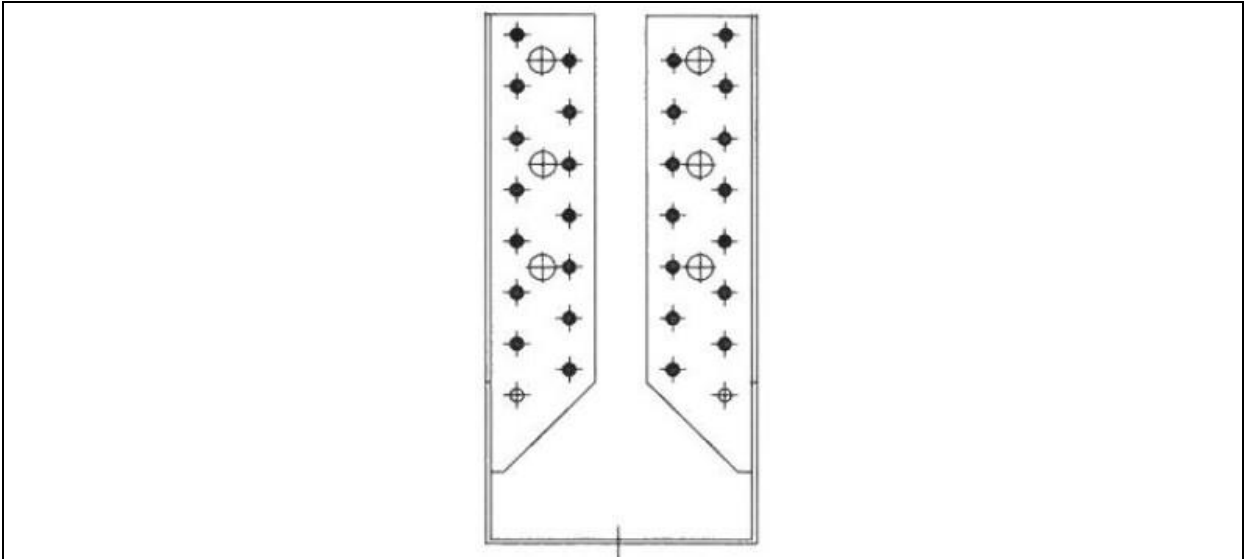

Figure 200 Type WBZ 29, WBZ 32, WBZ 34, WBZ 36, WBZ 37

THREE-DIMENSIONAL NAILING PLATES	ANNEX 5 ETA 22/0631
SPECIFICATION OF CONNECTION ELEMENTS	

Table 79 Specification of connection elements

Connector	Dowel type fastener	Fasteners per Detail [pc.]	Fasteners per Connection [pc.]
WB 1	ANCHOR Ø4x50/ANCHOR Ø4x50	8\12	8\12
WB 2	ANCHOR Ø4x50/ANCHOR Ø4x50	8\12	8\12
WB 3	ANCHOR Ø4x50/ANCHOR Ø4x50	16	16
WB 4	ANCHOR Ø4x50/ANCHOR Ø4x50	20	20
WB 5	ANCHOR Ø4x50/ANCHOR Ø4x50	8\12	8\12
WB 6	ANCHOR Ø4x50/ANCHOR Ø4x50	16	16
WB 7	ANCHOR Ø4x50/ANCHOR Ø4x50	20	20
WB 8	ANCHOR Ø4x50/ANCHOR Ø4x50	8\12	8\12
WB 9	ANCHOR Ø4x50/ANCHOR Ø4x50	16	16
WB 10	ANCHOR Ø4x50/ANCHOR Ø4x50	8\12	8\12
WB 11	ANCHOR Ø4x50/ANCHOR Ø4x50	16	16
WB 12	ANCHOR Ø4x50/ANCHOR Ø4x50	20	20
WB 13	ANCHOR Ø4x50/ANCHOR Ø4x50	24	24
WB 14	ANCHOR Ø4x50/ANCHOR Ø4x50	8\12	8\12
WB 15	ANCHOR Ø4x50/ANCHOR Ø4x50	16	16
WB 16	ANCHOR Ø4x50/ANCHOR Ø4x50	20	20
WB 17	ANCHOR Ø4x50/ANCHOR Ø4x50	24	24
WB 18	ANCHOR Ø4x50/ANCHOR Ø4x50	28	28
WB 19	ANCHOR Ø4x50/ANCHOR Ø4x50	8\12	8\12
WB 20	ANCHOR Ø4x50/ANCHOR Ø4x50	16	16
WB 21	ANCHOR Ø4x50/ANCHOR Ø4x50	16	16
WB 22	ANCHOR Ø4x50/ANCHOR Ø4x50	20	20
WB 23	ANCHOR Ø4x50/ANCHOR Ø4x50	16	16
WB 24	ANCHOR Ø4x50/ANCHOR Ø4x50	20	20
WB 25	ANCHOR Ø4x50/ANCHOR Ø4x50	24	24
WB 26	ANCHOR Ø4x50/ANCHOR Ø4x50	16	16
WB 27	ANCHOR Ø4x50/ANCHOR Ø4x50	20	20
WB 28	ANCHOR Ø4x50/ANCHOR Ø4x50	24	24
WB 29	ANCHOR Ø4x50/ANCHOR Ø4x50	28	28
WB 30	ANCHOR Ø4x50/ANCHOR Ø4x50	20	20
WB 31	ANCHOR Ø4x50/ANCHOR Ø4x50	24	24
WB 32	ANCHOR Ø4x50/ANCHOR Ø4x50	28	28
WB 33	ANCHOR Ø4x50/ANCHOR Ø4x50	24	24
WB 34	ANCHOR Ø4x50/ANCHOR Ø4x50	28	28
WB 35	ANCHOR Ø4x50/ANCHOR Ø4x50	24	24
WB 36	ANCHOR Ø4x50/ANCHOR Ø4x50	28	28
WB 37	ANCHOR Ø4x50/ANCHOR Ø4x50	28	28
WB 38	ANCHOR Ø4x50/ANCHOR Ø4x50	28	28

Connector	Dowel type fastener	Fasteners per Detail [pc.]	Fasteners per Connection [pc.]
WB 64	ANCHOR Ø4x50/ANCHOR Ø4x50	12	12
WBZ 20	Anchor Ø4x50	10/5	10/5
WBZ 21	ANCHOR Ø4x50/ANCHOR Ø4x50	8\12	8\12
WBZ 22	ANCHOR Ø4x50/ANCHOR Ø4x50	16\20	16\20
WBZ 23	ANCHOR Ø4x50/ANCHOR Ø4x50	8\12	8\12
WBZ 24	ANCHOR Ø4x50/ANCHOR Ø4x50	16\20	16\20
WBZ 25	ANCHOR Ø4x50/ANCHOR Ø4x50	24	24
WBZ 26	ANCHOR Ø4x50/ANCHOR Ø4x50	8\12	8\12
WBZ 27	ANCHOR Ø4x50/ANCHOR Ø4x50	16\20	16\20
WBZ 28	ANCHOR Ø4x50/ANCHOR Ø4x50	24	24
WBZ 29	ANCHOR Ø4x50/ANCHOR Ø4x50	28	28
WBZ 30	ANCHOR Ø4x50/ANCHOR Ø4x50	16\20	16\20
WBZ 31	ANCHOR Ø4x50/ANCHOR Ø4x50	24	24
WBZ 32	ANCHOR Ø4x50/ANCHOR Ø4x50	28	28
WBZ 33	ANCHOR Ø4x50/ANCHOR Ø4x50	24	24
WBZ 34	ANCHOR Ø4x50/ANCHOR Ø4x50	28	28
WBZ 35	ANCHOR Ø4x50/ANCHOR Ø4x50	24	24
WBZ 36	ANCHOR Ø4x50/ANCHOR Ø4x50	28	28
WBZ 37	ANCHOR Ø4x50/ANCHOR Ø4x50	28	28
WBD 105L	ANCHOR Ø4x50/ANCHOR Ø4x50	16	32
WBD 105P	ANCHOR Ø4x50/ANCHOR Ø4x50	16	32
WBD 130L	ANCHOR Ø4x50/ANCHOR Ø4x50	16	32
WBD130P	ANCHOR Ø4x50/ANCHOR Ø4x50	16	32
WBD 140L	ANCHOR Ø4x50/ANCHOR Ø4x50	16	32
WBD 140P	ANCHOR Ø4x50/ANCHOR Ø4x50	16	32
WBD 170L	ANCHOR Ø4x50/ANCHOR Ø4x50	16	32
WBD 170P	ANCHOR Ø4x50/ANCHOR Ø4x50	16	32
WBD 200L	ANCHOR Ø4x50/ANCHOR Ø4x50	16	32
WBD 200P	ANCHOR Ø4x50/ANCHOR Ø4x50	16	32
LK 1	ANCHOR Ø4x50	20	40
LK 2	ANCHOR Ø4x50	20	40
LK 3	ANCHOR Ø4x50	20	40
LK 4	ANCHOR Ø4x50	20	40
LK 5	ANCHOR Ø4x50	20	40
LK 6	ANCHOR Ø4x50	20	40
LK 7	ANCHOR Ø4x50	20	40
LK 8	ANCHOR Ø4x50	20	40
KG	ANCHOR Ø3.1x50	14	28
WL 5	ANCHOR Ø4x50/ANCHOR Ø4x50	6	6
WL 6	ANCHOR Ø4x50/ANCHOR Ø4x50	6	6
WL 7	ANCHOR Ø4x50/ANCHOR Ø4x50	6	6

Connector	Dowel type fastener	Fasteners per Detail [pc.]	Fasteners per Connection [pc.]
WL 8	ANCHOR Ø4x50/ANCHOR Ø4x50	6	6
WL 9	ANCHOR Ø4x50/ANCHOR Ø4x50	6	6
KRD 1	ANCHOR Ø4x50	8	16
KRD 2	ANCHOR Ø4x50	8	16
KRD 3	ANCHOR Ø4x50	9	18
KRD 4	ANCHOR Ø4x50	9	18
KMP 1	ANCHOR Ø4x50	8	16
KMP 2	ANCHOR Ø4x50	8	16
KMP 3	ANCHOR Ø4x50	8	16
KMP 4	ANCHOR Ø4x50	8	16
KMP 5	ANCHOR Ø4x50	14	28
KMP 6	ANCHOR Ø4x50	20	40
KMP 7	ANCHOR Ø4x50	12	24
KMP 8	ANCHOR Ø4x50	16	32
KMP 9	ANCHOR Ø4x50	28	56
KMR 1	ANCHOR Ø4x50	10	20
KMR 2	ANCHOR Ø4x50	10	20
KMR 3	ANCHOR Ø4x50	18	36
KMR 4	ANCHOR Ø4x50	18	36
KMR 5	ANCHOR Ø4x50	29	58
KMR 6	ANCHOR Ø4x50	29	58
KMR 7	ANCHOR Ø4x50	5	10
KMR 8	ANCHOR Ø4x50	11	22
KMR 9	ANCHOR Ø4x50	17	34
KMRP 1	ANCHOR Ø4x50	5	10
KMRP 2	ANCHOR Ø4x50	11	22
KMRP 3	ANCHOR Ø4x50	17	34
LZ 0	ANCHOR Ø4x50	7	7
LZ 1	ANCHOR Ø4x50	10	20
LZ 2	ANCHOR Ø4x50	10	20
LZ 3	ANCHOR Ø4x50	10	20
KS 1	ANCHOR Ø4x50	4	8
KSO 1	ANCHOR Ø4x50	4	8
KS 2	ANCHOR Ø4x50	4	8
KSO 2	ANCHOR Ø4x50	4	8
KS 3	ANCHOR Ø4x50	8	16
KSO 3	ANCHOR Ø4x50	8	16
KWO 1	ANCHOR Ø4x50	4	8
KWO 2	ANCHOR Ø4x50	4	8
KWO 3	ANCHOR Ø4x50	4	8
KWO 4	ANCHOR Ø4x50	4	8

Connector	Dowel type fastener	Fasteners per Detail [pc.]	Fasteners per Connection [pc.]
KB 1	ANCHOR Ø4x50	5	10
KB 2	ANCHOR Ø4x50	7	14
KB 3	ANCHOR Ø4x50	7	14
KP 1	ANCHOR Ø4x50	16	32
KPL 1	ANCHOR Ø4x50	16	32
KP 2	ANCHOR Ø4x50	20	40
KPL 2	ANCHOR Ø4x50	20	40
KP 3	ANCHOR Ø4x50	14	28
KPL 3	ANCHOR Ø4x50	14	28
KP 4	ANCHOR Ø4x50	16	32
KPL 4	ANCHOR Ø4x50	16	32
KP 5	ANCHOR Ø4x50	18	36
KP 6	ANCHOR Ø4x50	25	50
KP 10	Anchor Ø4x50	30	60
KPL10	Anchor Ø4x50	30	60
KP 11	ANCHOR Ø4x50	13	26
KP 12	Anchor Ø4x50	16	32
KPL 12	Anchor Ø4x50	16	32
KP 13	Anchor Ø4x50	18	36
KP 14	Anchor Ø4x50	21	42
KP 15	Anchor Ø4x50	8	16
KP 21	ANCHOR Ø4x50	18	36
KL 1	ANCHOR Ø4x50	8	16
KL 2	ANCHOR Ø4x50	16	32
KL 3	ANCHOR Ø4x50	16	32
KL 4	ANCHOR Ø4x50	16	32
KL 5	ANCHOR Ø4x50	20	40
KL 101	Anchor Ø4x50	8	16
KL 104	Anchor Ø4x50	16	32
KL 105	Anchor Ø4x50	20	40
KW 1	ANCHOR Ø4x50	4	8
KW 2	ANCHOR Ø4x50	4	8
KW 3	ANCHOR Ø4x50	4	8
KW 4	ANCHOR Ø4x50	4	8
KW 5	ANCHOR Ø4x50	4	8
KW 6	ANCHOR Ø4x50	4	8
KW 7	ANCHOR Ø4x50	4	8
KW 25	ANCHOR Ø4x50	4	8
KW 30	ANCHOR Ø4x50	4	8
KW 40	ANCHOR Ø4x50	4	8
KW 50	ANCHOR Ø4x50	4	8

Connector	Dowel type fastener	Fasteners per Detail [pc.]	Fasteners per Connection [pc.]
KW 60	ANCHOR Ø4x50	4	8
KW 80	ANCHOR Ø4x50	6	12
KW 100	ANCHOR Ø4x50	6	12
KW 125	ANCHOR Ø4x50	6	12
KW 150	ANCHOR Ø4x50	6	12
KK 1	ANCHOR Ø4x50	14	28
KK 2	ANCHOR Ø4x50	20	40
KK 3	ANCHOR Ø4x50	26	52
KK 21	ANCHOR Ø4x50/ISO 4014 M 12x35 - 8.8 (washer ISO 7094)	14\1	28\2
KK 22	ANCHOR Ø4x50/ISO 4014 M 12x35 - 8.8 (washer ISO 7094)	24\1	48\2
KK 23	ANCHOR Ø4x50/ISO 4014 M 12x35 - 8.8 (washer ISO 7094)	30\1	60\2
KM 0	Anchor Ø4x50	4	8
KM 1	ANCHOR Ø4x50	8	16
KM 2	ANCHOR Ø4x50	8	16
KM 3	ANCHOR Ø4x50	8	16
KM 4	ANCHOR Ø4x50	14	28
KM 5	ANCHOR Ø4x50	20	40
KM 6	ANCHOR Ø4x50	26	52
KM 7	ANCHOR Ø4x50	12	24
KM 8	ANCHOR Ø4x50	16	32
KM 9	ANCHOR Ø4x50	28	56
KM 10	ANCHOR Ø4x50	32	64
KM 11	ANCHOR Ø4x50	20	40
KM 12	ANCHOR Ø4x50	36	72
KM 13	ANCHOR Ø4x50	42	84
KM 14	ANCHOR Ø4x50	12	24
KM 15	ANCHOR Ø4x50	24	48
KM 19	ANCHOR Ø4x50	14	28
KM 20	ANCHOR Ø4x50	6	12
KM 21	Anchor Ø4x50	16	32
KM 1 (2.5 mm)	ANCHOR Ø4x50	8	16
KM 2 (2.5 mm)	ANCHOR Ø4x50	8	16
KM 4 (2.5 mm)	ANCHOR Ø4x50	14	28
KM 5 (2.5 mm)	ANCHOR Ø4x50	20	40
KM 6 (2.5 mm)	ANCHOR Ø4x50	26	52
KM 7 (2.5 mm)	ANCHOR Ø4x50	12	24
KM 9 (2.5 mm)	ANCHOR Ø4x50	28	56
KM 10 (2.5 mm)	ANCHOR Ø4x50	32	64
KM 11 (2.5 mm)	ANCHOR Ø4x50	20	40
KM 12 (2.5 mm)	ANCHOR Ø4x50	36	72

Connector	Dowel type fastener	Fasteners per Detail [pc.]	Fasteners per Connection [pc.]
KM 13 (2.5 mm)	ANCHOR Ø4x50	42	84
KM 14 (2.5 mm)	ANCHOR Ø4x50	12	24
KM 15 (2.5 mm)	ANCHOR Ø4x50	24	48
KM 16 (2.5 mm)	ANCHOR Ø4x50	12	24
KM 17 (2.5 mm)	ANCHOR Ø4x50	8	16
KM 18 (2.5 mm)	ANCHOR Ø4x50	12	24
KM 19 (2.5 mm)	ANCHOR Ø4x50	14	28
KM 20 (2.5 mm)	ANCHOR Ø4x50	6	12
KM 22 (2.5 mm)	Anchor Ø4x50	20	40
LBS 90	Anchor Ø4x50	18	36
LBS 105	Anchor Ø4x50	24	48
LBZ 95	ANCHOR Ø4x50/ISO 4014 M 12x35 - 8.8 (washer ISO 7094)	5\1	10\2
LBZ 135	ANCHOR Ø4x50/ISO 4014 M 12x35 - 8.8 (washer ISO 7094)	8\1	16\2
LBZ 285	ANCHOR Ø4x50/ISO 4014 M 12x35 - 8.8 (washer ISO 7094)	14\1	28\1

THREE-DIMENSIONAL NAILING PLATES	ANNEX 6 ETA 22/0631
REFERENCE DOCUMENTS	

- [1] European Assessment Document 130186-00-0603, edition July 2018,
Three-dimensional nailing plates
- [2] EN 10346 Continuously hot-dip coated steel flat products - Technical delivery conditions
- [3] EN 10131 Cold rolled uncoated and zinc or zinc-nickel electrolytically coated low carbon and high yield strength steel flat products for cold forming - Tolerances on dimensions and shape
- [4] EN 10025-2 Hot rolled products of structural steels - Part 2: Technical delivery conditions for non-alloy structural steels
- [5] EN 14592+A1 Timber structures - Dowel-type fasteners – Requirements
- [6] EN 1995-1-1 Eurocode 5: Design of timber structures - Part 1-1: General - Common rules and rules for buildings
- [7] EN ISO 12944-2 Paints and varnishes - Corrosion protection of steel structures by protective paint systems - Part 2: Classification of environments
- [8] EN ISO 8970 Timber structures - Testing of joints made with mechanical fasteners - Requirements for wood density
- [9] EN 26891 Timber structures – Joints made with mechanical fasteners – General principles for the determination of strength and deformation characteristics
- [10] EN 384+A2 Structural timber – Determination of characteristic values of mechanical properties and density
- [11] EN 13183-2 Moisture content of a piece of sawn timber - Part 2: Estimation by electrical resistance method
- [12] EN 1309-1 Round and sawn timber - Method of measurement of dimensions - Part 1: Sawn timber
- [13] EN 14358 Timber structures – Calculation and verification of characteristic values
- [14] EN 13501-1 Fire classification of construction products and building elements - Part 1: Classification using test data from reaction to fire tests
- [15] EN 10130 Cold rolled low carbon steel flat products for cold forming - Technical delivery conditions