



**Technický a zkušební ústav  
stavební Praha, s.p.**

Prosecká 811/76a  
190 00 Prague  
Czech Republic  
tel.: +420 286 019 400  
W: [www.tzus.cz](http://www.tzus.cz)



Member of



[www.eota.eu](http://www.eota.eu)

## European Technical Assessment

**ETA 22/0631**  
of 28/11/2023

General part

### Technical Assessment Body issuing the European Technical Assessment

Technický a zkušební ústav stavební Praha, s.p.

|   |   |
|---|---|
| <b>Trade name of the construction product</b>   | KB, KG, KK, KL, KM, KM (2.5 mm), KMP, KMR, KMRP, KSO, KP, KPL, KRD, KS, KW, KWO, LBZ, LK, LZ, WB, WBD, WBZ, WL, LBS |
| <b>Product family to which the construction product belongs</b>   | Product area: 13<br>Three-dimensional Nailing Plates  |
| <b>Manufacturer</b>   | DOMAX Sp. z o.o.<br>Aleja Parku Krajobrazowego 109<br>84-207 Koleczkowo<br>Łężyce<br>Republic of Poland             |
| <b>Manufacturing plant</b>  | DOMAX Sp. z o.o.<br>Aleja Parku Krajobrazowego 109<br>84-207 Koleczkowo<br>Łężyce<br>Republic of Poland             |
| <b>This European Technical Assessment contains</b>  | 142 pages including 6 Annexes, which form an integral part of this European Technical Assessment                    |
| <b>This European Technical Assessment is issued in accordance with Regulation (EU) No 305/2011, on the basis of</b> | EAD 130186-00-0603 Three-dimensional nailing plates   |
| <b>This version replaces</b>  | ETA 22/0631, version 01 issued on 31/10/2022  |

Translations of this European technical assessment in other languages shall fully correspond to the original issued document and should be identified as such.

Communication of this European Technical Assessment, including transmission by electronic means, shall be in full (excepted the confidential Annex(es) referred to above). However, partial reproduction may be made, with the written consent of the issuing Technical Assessment Body - Technický a zkušební ústav stavební Praha, s.p. Any partial reproduction has to be identified as such.

## 1 Technical description of the product

The three-dimensional nailing plates are one-piece, non-welded (KB, KG, KK, KL, KM, KM (2.5 mm), KMP, KMR, KMRP, KSO, KP, KPL, KRD, KS, KW, KWO, LBZ, LK, LZ, WB, WBD, WBZ, WL, LBS) elements made of the cold-formed steel sheet grade DX51D according to EN 10346, structural steel S235 according to EN 10025-2 or cold-formed steel grade DC01 according to EN 10130 with corrosion protection Fe/Zn 12, zinc coating mass of 275 g/m<sup>2</sup> or Hot-dip galvanization (HDG), (see list below). The three-dimensional nailing plates correspond to the drawings and dimensions given in Annex 1.

**Table 1** Technical description of the product

| Designation of Domax connector | Material | Thickness | Kind of corrosion protection | Type connector | Intended use  |
|--------------------------------|----------|-----------|------------------------------|----------------|---|
| WB 1                           | DX51D    | 2         | Z275                         | Beam-hanger    | Used to connect two piece of timber, end-grain to side-grain or timber – concrete or timber – steel |
| WB 2                           |          |           |                              |                |   |
| WB 3                           |          |           |                              |                |   |
| WB 4                           |          |           |                              |                |   |
| WB 5                           |          |           |                              |                |   |
| WB 6                           |          |           |                              |                |   |
| WB 7                           |          |           |                              |                |   |
| WB 8                           |          |           |                              |                |   |
| WB 9                           |          |           |                              |                |   |
| WB 10                          |          |           |                              |                |   |
| WB 11                          |          |           |                              |                |   |
| WB 12                          |          |           |                              |                |   |
| WB 13                          |          |           |                              |                |   |
| WB 14                          |          |           |                              |                |   |
| WB 15                          |          |           |                              |                |   |
| WB 16                          |          |           |                              |                |   |
| WB 17                          |          |           |                              |                |   |
| WB 18                          |          |           |                              |                |   |
| WB 19                          |          |           |                              |                |   |
| WB 20                          |          |           |                              |                |   |
| WB 21                          |          |           |                              |                |   |
| WB 22                          |          |           |                              |                |   |
| WB 23                          |          |           |                              |                |   |
| WB 24                          |          |           |                              |                |   |
| WB 25                          |          |           |                              |                |   |
| WB 26                          |          |           |                              |                |   |
| WB 27                          |          |           |                              |                |   |
| WB 28                          |          |           |                              |                |   |
| WB 29                          |          |           |                              |                |   |
| WB 30                          |          |           |                              |                |   |
| WB 31                          |          |           |                              |                |   |

| Designation of Domax connector | Material | Thickness | Kind of corrosion protection | Type connector | Intended use                        |
|--------------------------------|----------|-----------|------------------------------|----------------|-------------------------------------|
| WB 32                          |          |           |                              |                |                                     |
| WB 33                          |          |           |                              |                |                                     |
| WB 34                          |          |           |                              |                |                                     |
| WB 35                          |          |           |                              |                |                                     |
| WB 36                          |          |           |                              |                |                                     |
| WB 37                          |          |           |                              |                |                                     |
| WB 38                          |          |           |                              |                |                                     |
| WB 64                          |          |           |                              |                |                                     |
| WBZ 20                         | DX51D    | 2         | Z275                         | Beam-hanger    |                                     |
| WBZ 21                         |          |           |                              |                |                                     |
| WBZ 22                         |          |           |                              |                |                                     |
| WBZ 23                         |          |           |                              |                |                                     |
| WBZ 24                         |          |           |                              |                |                                     |
| WBZ 25                         |          |           |                              |                |                                     |
| WBZ 26                         |          |           |                              |                |                                     |
| WBZ 27                         |          |           |                              |                |                                     |
| WBZ 28                         |          |           |                              |                |                                     |
| WBZ 29                         |          |           |                              |                |                                     |
| WBZ 30                         |          |           |                              |                |                                     |
| WBZ 31                         |          |           |                              |                |                                     |
| WBZ 32                         |          |           |                              |                |                                     |
| WBZ 33                         |          |           |                              |                |                                     |
| WBZ 34                         |          |           |                              |                |                                     |
| WBZ 35                         |          |           |                              |                |                                     |
| WBZ 36                         |          |           |                              |                |                                     |
| WBZ 37                         |          |           |                              |                |                                     |
| WBD 105L                       | DX51D    | 2         | Z275                         | Beam-hanger    |                                     |
| WBD 105P                       |          |           |                              |                |                                     |
| WBD 130L                       |          |           |                              |                |                                     |
| WBD130P                        |          |           |                              |                |                                     |
| WBD 140L                       |          |           |                              |                |                                     |
| WBD 140P                       |          |           |                              |                |                                     |
| WBD 170L                       |          |           |                              |                |                                     |
| WBD 170P                       |          |           |                              |                |                                     |
| WBD 200L                       |          |           |                              |                |                                     |
| WBD 200P                       |          |           |                              |                |                                     |
| WL 5                           | DX51D    | 1         | Z275                         | Beam-hanger    |                                     |
| WL 6                           |          |           |                              |                |                                     |
| WL 7                           |          |           |                              |                |                                     |
| WL 8                           |          |           |                              |                |                                     |
| WL 9                           |          |           |                              |                |                                     |
| LK 1                           | DX51D    | 2         | Z275                         | Angle          | Used to connect two piece of timber |
| LK 2                           |          |           |                              |                |                                     |

| Designation of Domax connector | Material | Thickness | Kind of corrosion protection | Type connector | Intended use   |
|--------------------------------|----------|-----------|------------------------------|----------------|--|
| LK 3                           |          |           |                              |                |  |
| LK 4                           |          |           |                              |                |  |
| LK 5                           |          |           |                              |                |  |
| LK 6                           |          |           |                              |                |  |
| LK 7                           |          |           |                              |                |  |
| LK 8                           |          |           |                              |                |  |
| KG                             | DX51D    | 1.5       | Z275                         | Angle          |  |
| KRD 1                          | DX51D    | 2         | Z275                         | Angle          | Used to connect two piece of timber or timber – concrete or timber – steel |
| KRD 2                          |          |           |                              |                |  |
| KRD 3                          |          |           |                              |                |  |
| KRD 4                          |          |           |                              |                |  |
| KMP 1                          | DX51D    | 1.5       | Z275                         | Angle          | Used to connect two piece of timber  |
| KMP 2                          |          |           |                              |                |  |
| KMP 3                          |          |           |                              |                |  |
| KMP 4                          |          |           |                              |                |  |
| KMP 5                          |          |           |                              |                |  |
| KMP 6                          |          |           |                              |                |  |
| KMP 7                          |          |           |                              |                |  |
| KMP 8                          |          |           |                              |                |  |
| KMP 9                          | DX51D    | 2         | Z275                         | Angle          | Used to connect two piece of timber or timber – concrete or timber – steel |
| KMR 1                          |          |           |                              |                |  |
| KMR 2                          |          |           |                              |                |  |
| KMR 3                          |          |           |                              |                |  |
| KMR 4                          |          |           |                              |                |  |
| KMR 5                          |          |           |                              |                |  |
| KMR 6                          |          |           |                              |                |  |
| KMR 7                          |          |           |                              |                |  |
| KMR 8                          |          |           |                              |                |  |
| KMR 9                          | DX51D    | 2         | Z275                         | Angle          |  |
| KMRP 1                         |          |           |                              |                |  |
| KMRP 2                         |          |           |                              |                |  |
| KMRP 3                         | DX51D    | 2.5       | Z275                         | Angle          |  |
| LZ 0                           |          |           |                              |                |  |
| LZ 1                           |          |           |                              |                |  |
| LZ 2                           |          |           |                              |                |  |
| LZ 3                           | DC01     | 1.5       | Fe/Zn 12                     | Angle          |  |
| KS 1                           |          |           |                              |                |  |
| KS 2                           |          |           |                              |                |  |
| KS 3                           | DX51D    | 1.5       | Z275                         | Angle          | Used to connect two piece of timber  |
| KSO 1                          |          |           |                              |                |  |
| KSO 2                          |          |           |                              |                |  |
| KSO 3                          |          |           |                              |                |  |
| KWO 1                          | DX51D    | 1.5       | Z275                         | Angle          |  |

| Designation of Domax connector | Material | Thickness | Kind of corrosion protection | Type connector | Intended use   |
|--------------------------------|----------|-----------|------------------------------|----------------|--|
| KWO 2                          |          | 2         |                              |                |  |
| KWO 3                          |          |           |                              |                |  |
| KWO 4                          |          |           |                              |                |  |
| KB 1                           | S235     | 3         | Fe/Zn 12                     | Angle          |  |
| KB 2                           |          | 4         |                              |                |  |
| KB 3                           |          | 5         |                              |                |  |
| KP 1                           | DX51D    | 2.5       | Z275                         | Angle          | Used to connect two piece of timber or timber – concrete or timber – steel |
| KP 2                           |          |           |                              |                |  |
| KP 3                           |          |           |                              |                |  |
| KP 4                           |          |           |                              |                |  |
| KP 5                           |          |           |                              |                |  |
| KP 6                           |          |           |                              |                |  |
| KP 10                          |          |           |                              |                |  |
| KP 11                          |          |           |                              |                |  |
| KP 12                          |          |           |                              |                |  |
| KP 13                          |          |           |                              |                |  |
| KP 14                          |          |           |                              |                |  |
| KP 15                          |          |           |                              |                |  |
| KP 21                          |          |           |                              |                |  |
| KPL 1                          |          |           |                              |                |  |
| KPL 2                          |          |           |                              |                |  |
| KPL 3                          |          |           |                              |                |  |
| KPL 4                          |          |           |                              |                |  |
| KPL 10                         |          |           |                              |                |  |
| KPL 12                         |          |           |                              |                |  |
| KL 1                           | DX51D    | 2.5       | Z275                         | Angle          |  |
| KL 2                           |          |           |                              |                |  |
| KL 3                           |          |           |                              |                |  |
| KL 4                           |          |           |                              |                |  |
| KL 5                           |          | 2         |                              |                |  |
| KL 101                         |          |           |                              |                |  |
| KL 104                         |          |           |                              |                |  |
| KL 105                         |          |           |                              |                |  |
| KW 1                           | DC01     | 1.5       | Fe/Zn 12                     | Angle          |  |
| KW 2                           |          | 2         |                              |                |  |
| KW 3                           |          |           |                              |                |  |
| KW 4                           |          |           |                              |                |  |
| KW 5                           | S235     | 4         |                              |                |  |
| KW 6                           |          | 5         |                              |                |  |
| KW 7                           | DC01     | 1.5       |                              |                |  |
| KW 25                          |          |           |                              |                |  |
| KW 30                          |          |           |                              |                |  |
| KW 40                          |          |           |                              |                |  |

| Designation of Domax connector | Material | Thickness | Kind of corrosion protection | Type connector | Intended use   |
|--------------------------------|----------|-----------|------------------------------|----------------|--|
| KW 50                          |          | 2         |                              |                |  |
| KW 60                          |          |           |                              |                |  |
| KW 80                          |          |           |                              |                |  |
| KW 100                         |          |           |                              |                |  |
| KW 125                         |          |           |                              |                |  |
| KW 150                         |          |           |                              |                |  |
| KK 1                           | DX51D    | 2         | Z275                         | Angle          | Used to connect two piece of timber  |
| KK 2                           |          |           |                              |                |  |
| KK 3                           |          |           |                              |                |  |
| KK 21                          | DX51D    | 2         | Z275                         | Angle          | Used to connect two piece of timber or timber – concrete or timber – steel |
| KK 22                          |          |           |                              |                |  |
| KK 23                          |          |           |                              |                |  |
| KM 0                           | DX51D    | 2         | Z275                         | Angle          | Used to connect two piece of timber  |
| KM 1                           |          |           |                              |                |  |
| KM 2                           |          |           |                              |                |  |
| KM 3                           |          |           |                              |                |  |
| KM 4                           |          |           |                              |                |  |
| KM 5                           |          |           |                              |                |  |
| KM 6                           |          |           |                              |                |  |
| KM 7                           |          |           |                              |                |  |
| KM 8                           |          |           |                              |                |  |
| KM 9                           |          |           |                              |                |  |
| KM 10                          |          |           |                              |                |  |
| KM 11                          |          |           |                              |                |  |
| KM 12                          |          |           |                              |                |  |
| KM 13                          |          |           |                              |                |  |
| KM 14                          |          |           |                              |                |  |
| KM 15                          |          |           |                              |                |  |
| KM 19                          |          |           |                              |                |  |
| KM 20                          |          |           |                              |                |  |
| KM 21                          |          |           |                              |                |  |
| KM 1 (2.5 mm)                  | DX51D    | 2.5       | Z275                         | Angle          |  |
| KM 2 (2.5 mm)                  |          |           |                              |                |  |
| KM 4 (2.5 mm)                  |          |           |                              |                |  |
| KM 5 (2.5 mm)                  |          |           |                              |                |  |
| KM 6 (2.5 mm)                  |          |           |                              |                |  |
| KM 7 (2.5 mm)                  |          |           |                              |                |  |
| KM 8 (2.5 mm)                  |          |           |                              |                |  |
| KM 9 (2.5 mm)                  |          |           |                              |                |  |
| KM 10 (2.5 mm)                 |          |           |                              |                |  |
| KM 11 (2.5 mm)                 |          |           |                              |                |  |
| KM 12 (2.5 mm)                 |          |           |                              |                |  |

| Designation of Domax connector | Material | Thickness | Kind of corrosion protection            | Type connector | Intended use   |
|--------------------------------|----------|-----------|---|----------------|--|
| KM 13 (2.5 mm)                 |          |           |   |                |  |
| KM 14 (2.5 mm)                 |          |           |   |                |  |
| KM 15 (2.5 mm)                 |          |           |   |                |  |
| KM 16 (2.5 mm)                 |          |           |   |                |  |
| KM 17 (2.5 mm)                 |          |           |   |                |  |
| KM 18 (2.5 mm)                 |          |           |   |                |  |
| KM 19 (2.5 mm)                 |          |           |   |                |  |
| KM 20 (2.5 mm)                 |          |           |   |                |  |
| KM 22 (2.5 mm)                 |          |           |   |                |  |
| LBS 90                         | DX51D    | 1.5       | Z275                                    | Angle          | Used to connect two piece of timber or timber – concrete or timber – steel |
| LBS 105                        |          | 2         |   |                |  |
| LBZ 95                         | S235     | 4         | Fe/Zn 12 or Hot-dip galvanization (HDG) | Angle          |  |
| LBZ 135                        |          |           |   |                |  |
| LBZ 285                        |          |           |   |                |  |

Yield strength for used steel DX51D is 307 MPa, tensile strength is 371 MPa (thickness 1.0 mm).  
Yield strength for used steel DX51D is 294 MPa, tensile strength is 362 MPa (thickness 1.5 mm).  
Yield strength for used steel DX51D is 251 MPa, tensile strength is 356 MPa (thickness 2.0 mm).  
Yield strength for used steel DX51D is 288 MPa, tensile strength is 368 MPa (thickness 2.5 mm).

Yield strength for used steel DC01 is 199 MPa, tensile strength is 317 MPa (thickness 1.5 mm).  
Yield strength for used steel DC01 is 200 MPa, tensile strength is 332 MPa (thickness 2.0 mm).

Yield strength for used steel S235JR is 312 MPa, tensile strength is 401 MPa (thickness 3.0 mm).  
Yield strength for used steel S235JR is 307 MPa, tensile strength is 387 MPa (thickness 4.0 mm).  
Yield strength for used steel S235JR is 304 MPa, tensile strength is 410 MPa (thickness 5.0 mm).

## 1.1 Identification

The identification parameters and reference to product specifications for identifying the materials and components which constitute the three-dimensional nailing plates are given in Annexes.

## 2 Specification of the intended use(s) in accordance with the applicable European Assessment Document (hereinafter EAD)

The three-dimensional nailing plates are intended to be used as connections in loadbearing timber structures (to connect two pieces of timber or timber to concrete or steel). For connecting the mutually perpendicular, load-bearing, solid timber elements, end-grain to side-grain, in joints for which requirements for mechanical resistance and stability in the sense of the Basic Works Requirement 1 of Regulation (EU) No 305/2011 shall be fulfilled.

For connections made with the three-dimensional nailing plates shall be used the elements described in Annex 1.

The materials' specification or minimum corrosion protection for different service classes are stated in accordance with EN 1995-1-1 (Eurocode 5). Alternative materials may be used provided that they have sufficient corrosion protection for the proposed intended use shown

by assessment or testing taking into account the connection points between the nailing plate and the fastener and that they do not change performance of the nailing plate.

The provisions made in this European Technical Assessment are based on an assumed working life of the product of 50 years. The indications given on the working life cannot be interpreted as a guarantee given by the producer, but are to be regarded only as a means for choosing the right products in relation to the expected economically reasonable working life of the works.

The assessment of the fitness of the three-dimensional nailing plates for the intended use has been made in compliance with the European Assessment Document (EAD) 130186-00-0603 Three-dimensional nailing plates.

## **2.1 Installation of three-dimensional nailing plates**

The installation instructions including special installation techniques and provisions for the qualification of the personnel are given in the manufacturer's technical documentation.



### 3 Performance of the product and references to the methods used for its assessment

The assessment of the fitness for use of the above-mentioned three-dimensional nailing plates according to the Basic Work Requirements (BWR) were carried out in compliance with EAD 130186-00-0603.

The European Technical Assessment is issued for the three-dimensional nailing plates on the basis of agreed data and information, deposited at Technický a zkušební ústav stavební Praha, s.p., which identifies three-dimensional nailing plates that has been assessed and judged. Changes to the plates or production process which could result in this deposited data and information being incorrect should be notified to Technický a zkušební ústav stavební Praha, s.p. before the changes are introduced. Technický a zkušební ústav stavební Praha, s.p. will decide whether or not such changes affect the ETA and consequently the validity of the CE marking on the basis of the ETA and if so whether further assessment or alternations to the ETA shall be necessary.

**Table 2** Essential characteristics of the product

|  | Essential characteristic                  | Performance   |
|--|---|---|
| 3.1 BWR 1: Mechanical resistance and stability |   |   |
| 3.1.1  | Joint strength                            | See Annex 3   |
| 3.1.2  | Joint stiffness                           | NPA   |
| 3.1.3  | Joint ductility                           | NPA   |
| 3.1.4  | Resistance to seismic actions             | NPA   |
| 3.1.5  | Resistance to corrosion and deterioration | NPA   |
| 3.2 BWR 2: Safety in case of fire              |   |   |
| 3.2.1  | Reaction to fire                          | The steel elements are classified as class A1 of reaction to fire (non-combustible products) in accordance with EN 13501-1 and to European Commission Decision 96/603/EC amended by European Commission Decision 2000/605/EC. |
| 3.2.2  | Resistance to fire                        | NPA   |

#### 3.1 Mechanical resistance and stability (BWR 1)

##### 3.1.1 Joint strength

The load-carrying capacities of joints loaded according to static diagrams (shown in Annex 2), determined by testing or calculations carried out according to EAD 130186-00-0603, clause 2.2.1 and EN 1995-1-1 are given in Annex 3. The load-carrying capacities of joints for other load directions shall be calculated on the basis of EN 1995-1-1 (Eurocode 5) or according to national regulations. The design values shall be determined according to EN 1995-1-1 (Eurocode 5).

Following the requirements of EAD, the applicant provided to the TAB calculation and testing results, configuration of the connections and static schemes (direction of force actions).

##### 3.1.2 Joint stiffness

No performance assessed.

##### 3.1.3 Joint ductility

No performance assessed.

## **3.2 Safety in case of fire (BWR 2)**

### **3.2.1 Reaction to fire**

The steel elements are classified as class A1 of reaction to fire (non-combustible products) in accordance with EN 13501-1 and to European Commission Decision 96/603/EC amended by European Commission Decision 2000/605/EC.

### **3.2.2 Resistance to fire**

Performance in relation to fire resistance would be determined for the complete structural element with any associated finishes, therefore there is no performance assessed option used to this Basic Work Requirement.

#### 4 Assessment and verification of constancy of performance (hereinafter AVCP) system applied, with reference to its legal base

According to the Decision 1997/638/EC<sup>1</sup>, of the European Commission the system(s) of assessment and verification of constancy of performance (see Annex V to Regulation (EU) No 305/2011 and Commission delegated Regulation (EU) No 568/2014) given in the following table applies:

| Product(s)   | Intended use(s)                | Level(s) or class(es) | Attestation of conformity system(s) |
|--|--------------------------------|-----------------------|-------------------------------------|
| <b>Shear plates, toothed-plate connectors, punched nail plates, nailing plates</b> | For structural timber products |                       | 2+                                  |

---

<sup>1</sup> Official Journal of the European Communities L 268/37 of 1.10.1997

## **5 Technical details necessary for the implementation of the AVCP system, as provided for in the applicable EAD**

Technical details necessary for the implementation of the AVCP system are laid down in the control plan deposited at Technický a zkušební ústav stavební Praha, s.p.

Issued in Prague on 28/11/2023

By  
Ing. Jiří Studnička, Ph.D.  
Head of the TAB

### Annexes:

- Annex 1 Product details and definitions
- Annex 2 Loading according to static diagrams
- Annex 3 The load-carrying capacities of connectors
- Annex 4 Nailing patterns
- Annex 5 Specification of connection elements
- Annex 6 Reference documents

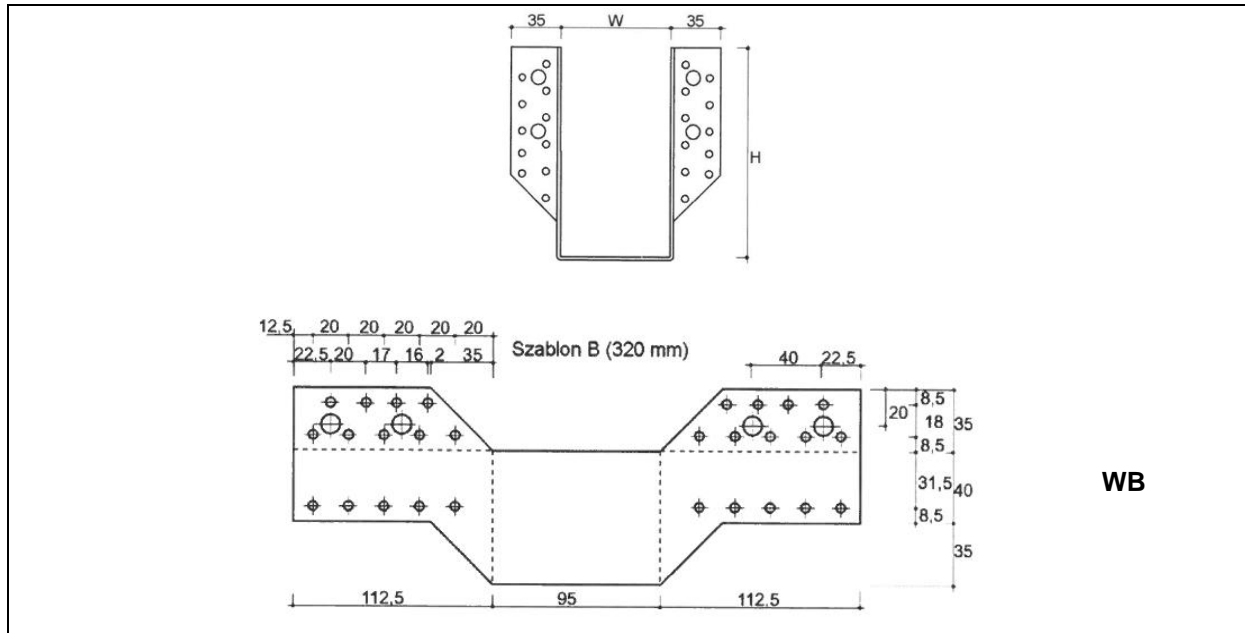
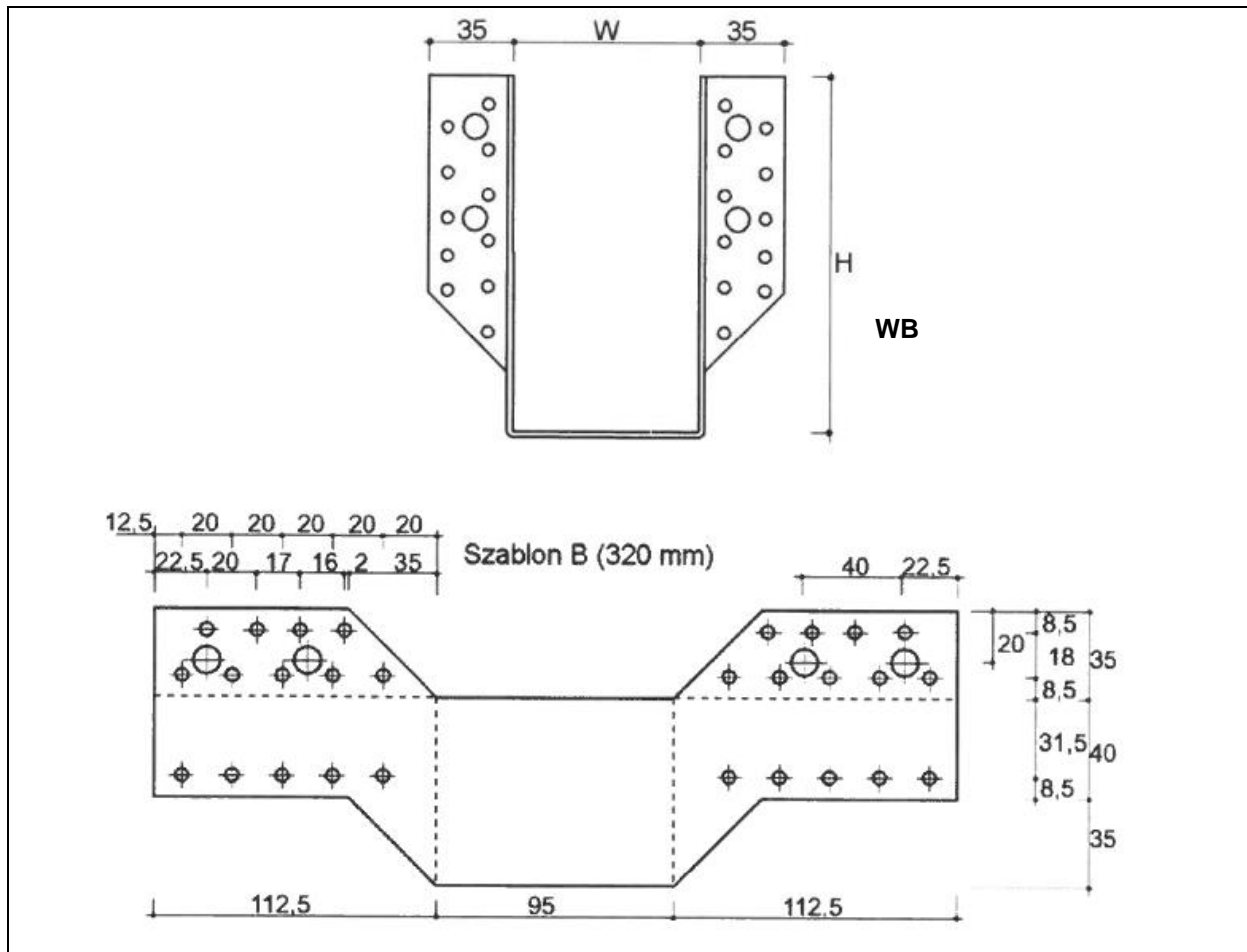


Figure 1 Type WB

Table 3 WB three-dimensional nailing plate symbols and dimensions

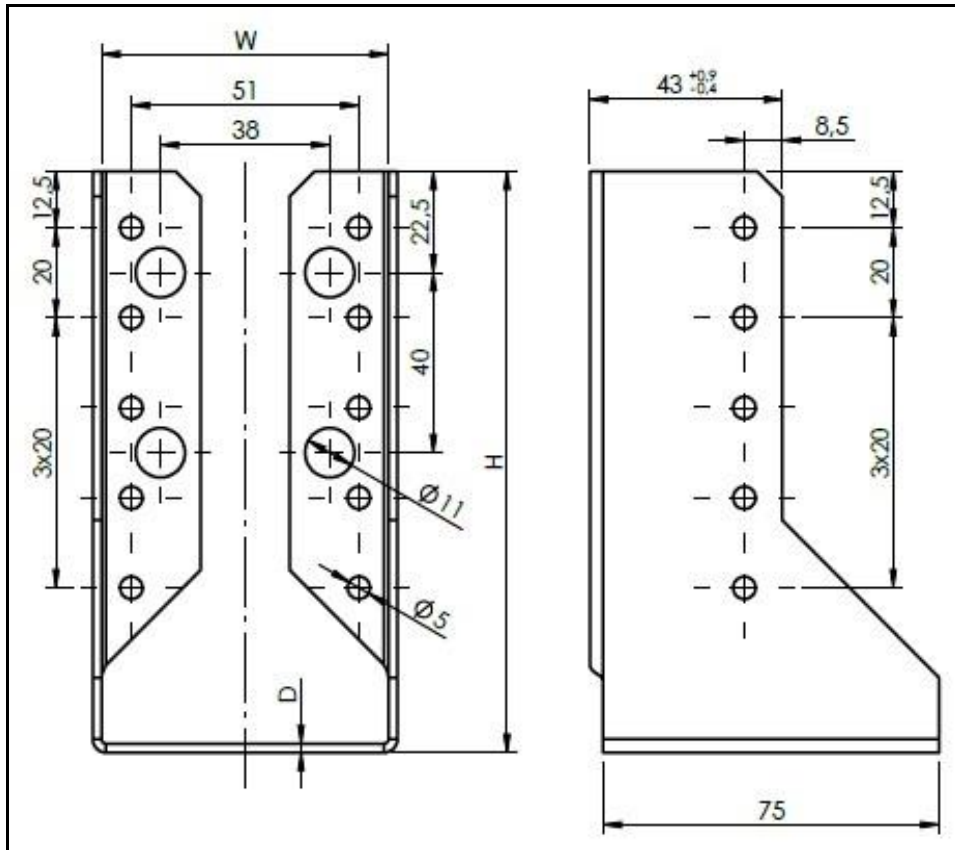
| Symbol | Dimensions [mm] |     | Template | Quantity of openings |      |
|--------|-----------------|-----|----------|----------------------|------|
|        | W               | H   |          | Ø 5                  | Ø 11 |
| WB1    | 25              | 118 | A        | 22                   | 2    |
| WB2    | 38              | 111 | A        | 22                   | 2    |
| WB3    | 38              | 141 | B        | 28                   | 4    |
| WB4    | 38              | 171 | C        | 34                   | 4    |
| WB5    | 41              | 110 | A        | 22                   | 2    |
| WB6    | 41              | 140 | B        | 28                   | 4    |
| WB7    | 41              | 170 | C        | 34                   | 4    |
| WB8    | 45              | 108 | A        | 22                   | 2    |
| WB9    | 45              | 138 | B        | 28                   | 4    |
| WB10   | 51              | 105 | A        | 22                   | 2    |
| WB11   | 51              | 135 | B        | 28                   | 4    |
| WB12   | 51              | 165 | C        | 34                   | 4    |
| WB13   | 51              | 195 | D        | 40                   | 6    |
| WB14   | 60              | 100 | A        | 22                   | 2    |
| WB15   | 60              | 130 | B        | 28                   | 4    |
| WB16   | 60              | 160 | C        | 34                   | 4    |
| WB17   | 60              | 190 | D        | 40                   | 6    |
| WB18   | 60              | 220 | E        | 46                   | 6    |
| WB19   | 64              | 98  | A        | 22                   | 2    |



**Figure 2** Type WB

**Table 4** WB three-dimensional nailing plate symbols and dimensions

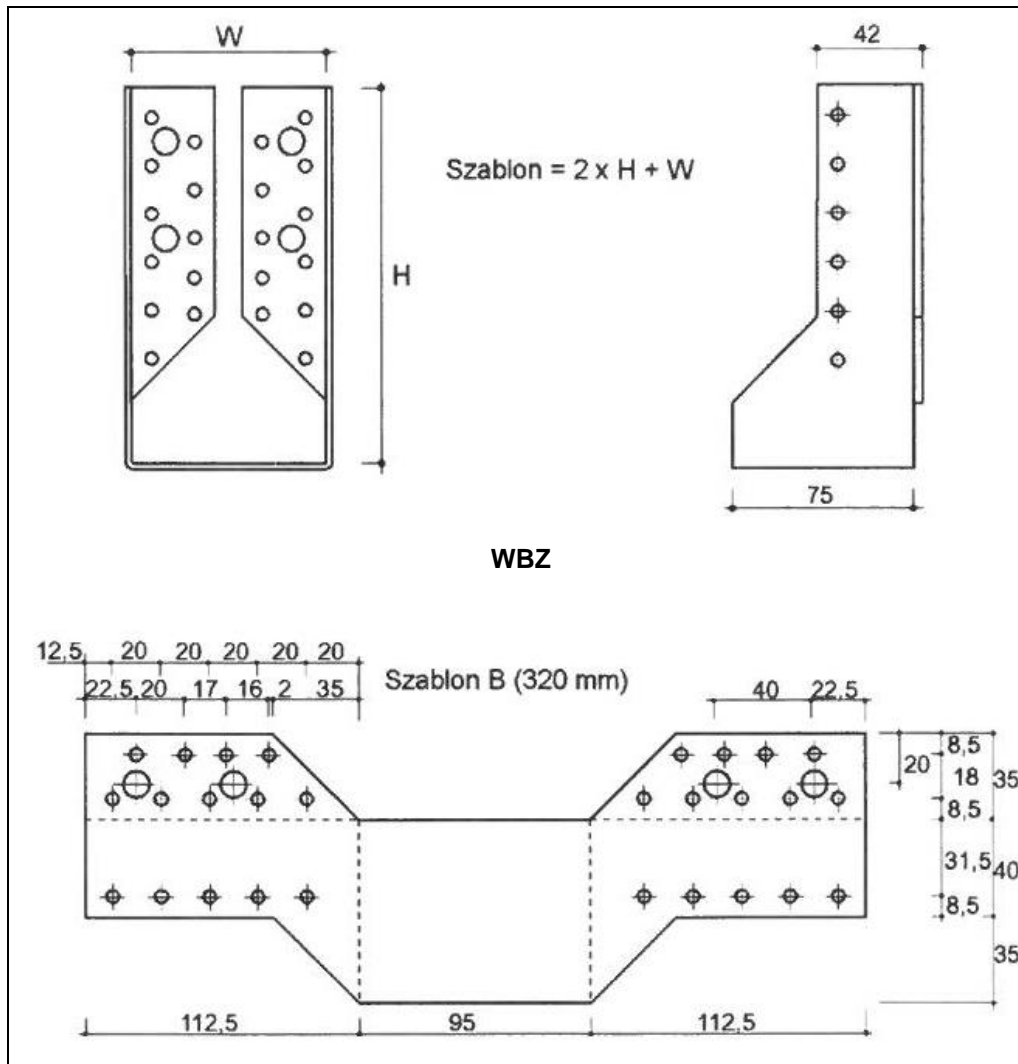
| Symbol | Dimensions [mm] |     | Template | Quantity of openings |      |
|--------|-----------------|-----|----------|----------------------|------|
|        | W               | H   |          | Ø 5                  | Ø 11 |
| WB20   | 64              | 128 | B        | 28                   | 4    |
| WB21   | 70              | 125 | B        | 28                   | 4    |
| WB22   | 70              | 155 | C        | 34                   | 4    |
| WB23   | 76              | 122 | B        | 28                   | 4    |
| WB24   | 76              | 152 | C        | 34                   | 4    |
| WB25   | 76              | 182 | D        | 40                   | 6    |
| WB26   | 80              | 120 | B        | 28                   | 4    |
| WB27   | 80              | 150 | C        | 34                   | 4    |
| WB28   | 80              | 180 | D        | 40                   | 6    |
| WB29   | 80              | 210 | E        | 46                   | 6    |
| WB30   | 100             | 140 | C        | 34                   | 4    |
| WB31   | 100             | 170 | D        | 40                   | 6    |
| WB32   | 100             | 200 | E        | 46                   | 6    |
| WB33   | 115             | 163 | D        | 40                   | 6    |
| WB34   | 115             | 193 | E        | 46                   | 6    |
| WB35   | 120             | 160 | D        | 40                   | 6    |
| WB36   | 120             | 190 | E        | 46                   | 6    |
| WB37   | 140             | 180 | E        | 46                   | 6    |
| WB38   | 160             | 170 | E        | 46                   | 6    |



**Figure 3** Type WBZ

**Table 5** WBZ three-dimensional nailing plate symbols and dimensions

| Symbol | Dimensions [mm] |     |   | Quantity of openings |     |
|--------|-----------------|-----|---|----------------------|-----|
|        | W               | H   | D | Ø5                   | Ø11 |
| WBZ 20 | 64              | 129 | 2 | 20                   | 4   |



**Figure 4** Type WBZ

**Table 6** WBZ three-dimensional nailing plate symbols and dimensions

| Symbol | Dimensions [mm] |     | Template | Quantity of openings |      |
|--------|-----------------|-----|----------|----------------------|------|
|        | W               | H   |          | Ø 5                  | Ø 11 |
| WBZ21  | 70              | 125 | B        | 28                   | 4    |
| WBZ22  | 70              | 155 | C        | 34                   | 4    |
| WBZ23  | 76              | 122 | B        | 28                   | 4    |
| WBZ24  | 76              | 152 | C        | 34                   | 4    |
| WBZ25  | 76              | 182 | D        | 40                   | 6    |
| WBZ26  | 80              | 120 | B        | 28                   | 4    |
| WBZ27  | 80              | 150 | C        | 34                   | 4    |
| WBZ28  | 80              | 180 | D        | 40                   | 6    |
| WBZ29  | 80              | 210 | E        | 46                   | 6    |
| WBZ30  | 100             | 140 | C        | 34                   | 4    |
| WBZ31  | 100             | 170 | D        | 40                   | 6    |
| WBZ32  | 100             | 200 | E        | 46                   | 6    |
| WBZ33  | 115             | 163 | D        | 40                   | 6    |
| WBZ34  | 115             | 193 | E        | 46                   | 6    |
| WBZ35  | 120             | 160 | D        | 40                   | 6    |
| WBZ36  | 120             | 190 | E        | 46                   | 6    |
| WBZ37  | 140             | 180 | E        | 46                   | 6    |



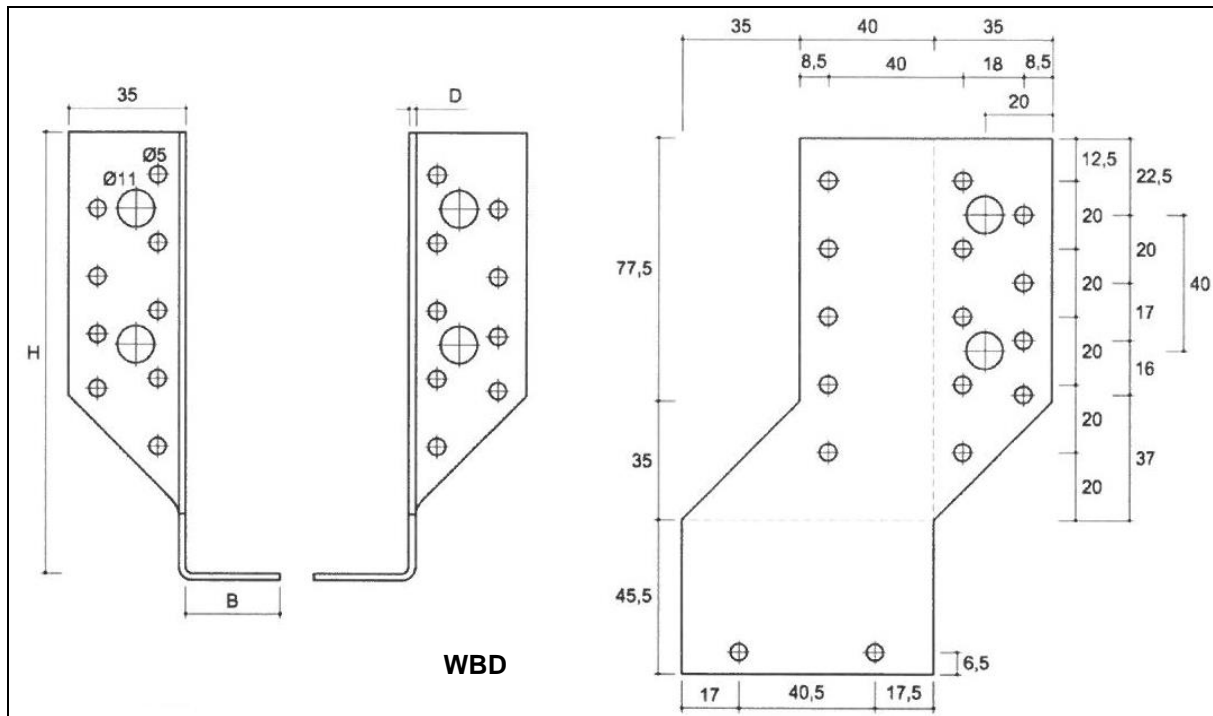
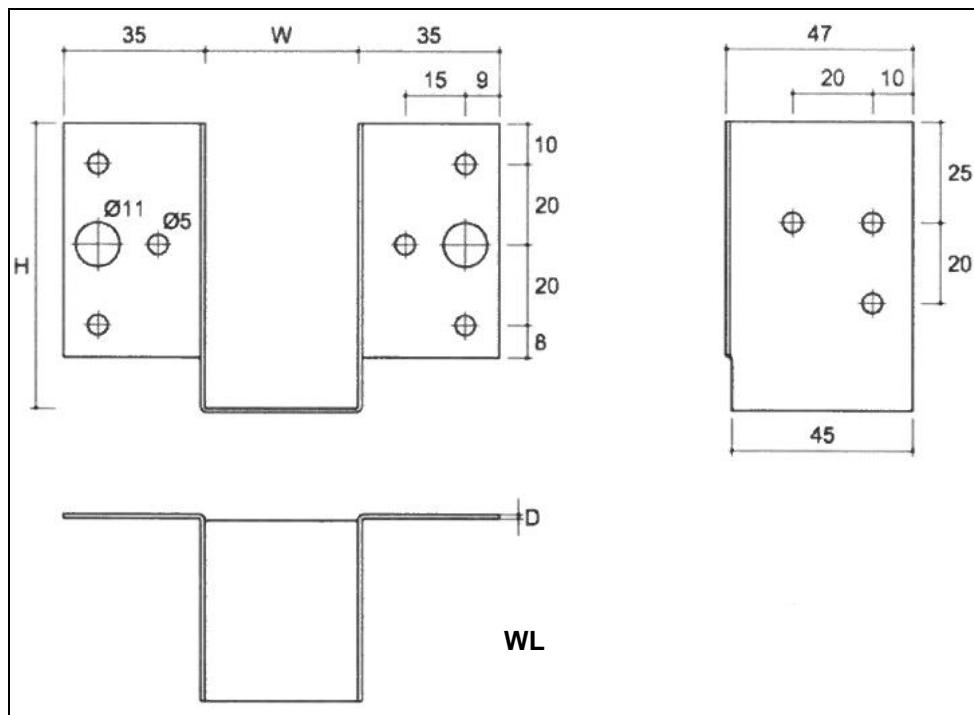


Figure 5 Type WBD

Table 7 WBD three-dimensional nailing plate symbols and dimensions

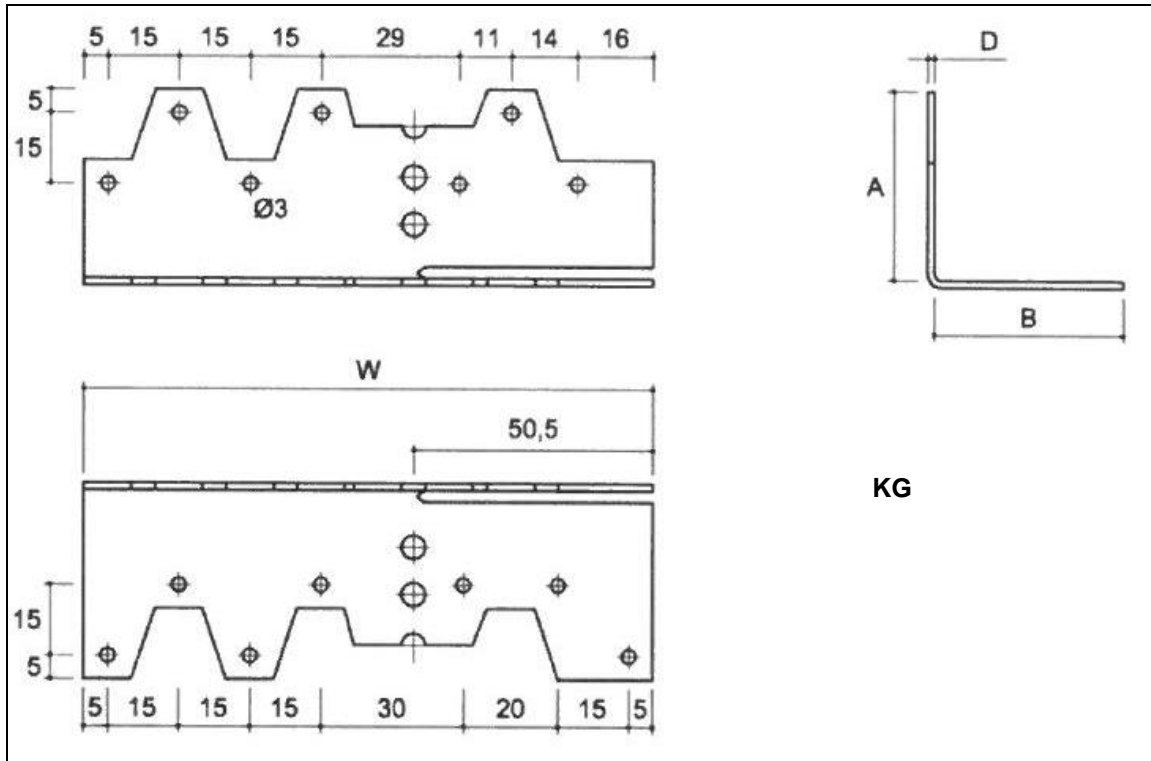
| Symbol             | Dimensions [mm] |    |   | Type | Quantity of openings |      |
|--------------------|-----------------|----|---|------|----------------------|------|
|                    | H               | B  | D |      | Ø 5                  | Ø 11 |
| WBD105L<br>WBD105P | 105             | 25 | 2 | A1   | 13                   | 1    |
| WBD130L<br>WBD130P | 130             | 28 | 2 | B1   | 16                   | 2    |
| WBD140L<br>WBD140P | 140             | 50 | 2 | C1   | 19                   | 2    |
| WBD170L<br>WBD170P | 170             | 50 | 2 | D1   | 22                   | 3    |
| WBD200L<br>WBD200P | 200             | 50 | 2 | E1   | 25                   | 3    |



**Figure 6** Type WL

**Table 8** WL three-dimensional nailing plate symbols and dimensions

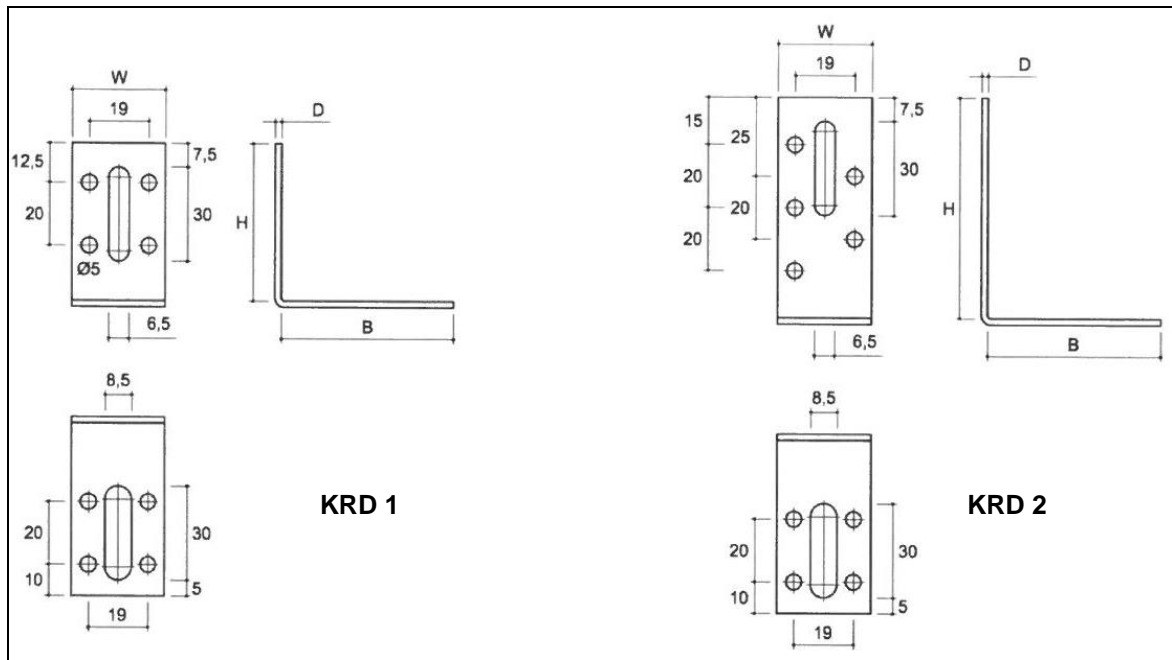
| Symbol | Dimensions [mm] |    |   | Quantity of openings |      |
|--------|-----------------|----|---|----------------------|------|
|        | W               | H  | D | Ø 5                  | Ø 11 |
| WL 5   | 25              | 77 | 1 | 12                   | 2    |
| WL 6   | 38              | 71 | 1 | 12                   | 2    |
| WL 7   | 41              | 70 | 1 | 12                   | 2    |
| WL 8   | 51              | 65 | 1 | 12                   | 2    |
| WL 9   | 60              | 60 | 1 | 12                   | 2    |



**Figure 7** Type KG

**Table 9** KG three-dimensional nailing plate symbols and dimensions

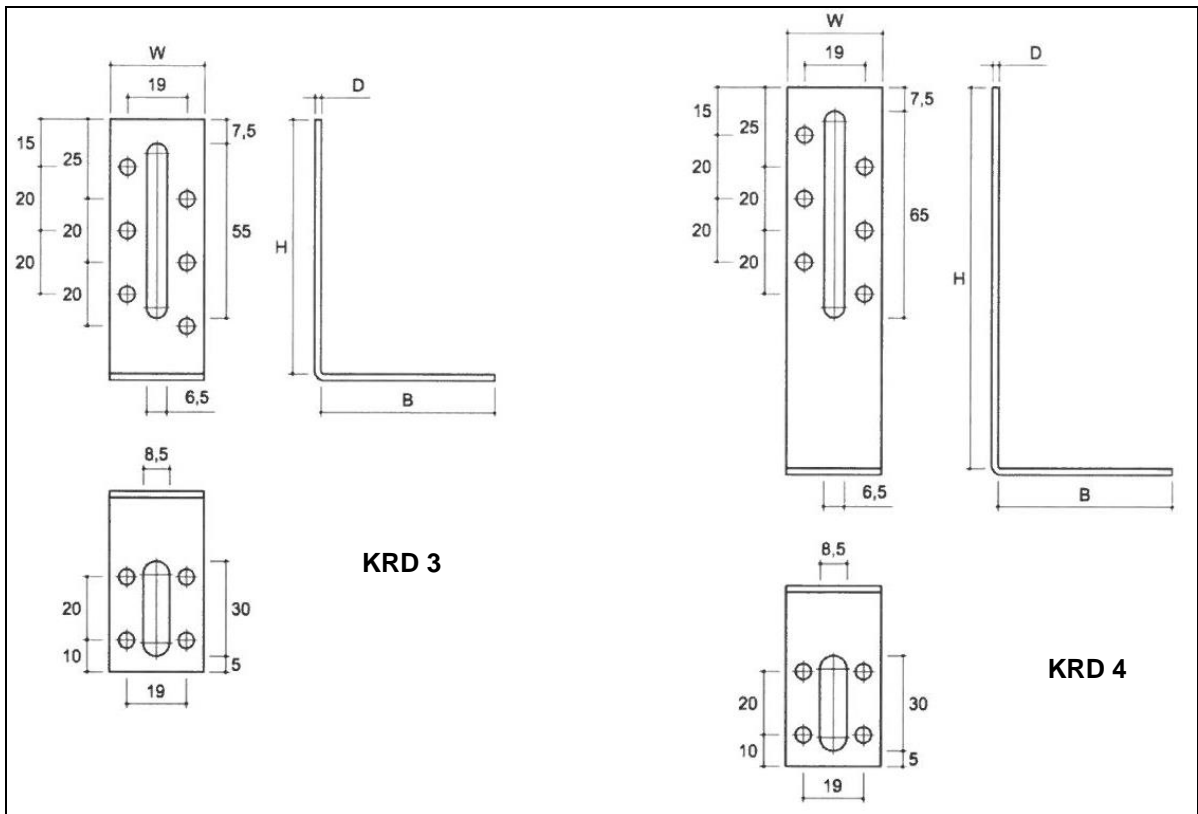
| Symbol | Dimensions [mm] |    |    |     | Quantity of openings |
|--------|-----------------|----|----|-----|----------------------|
|        | W               | A  | B  | D   |                      |
| KG     | 120             | 40 | 40 | 1.5 | 14                   |



**Figure 8** Type KRD

**Table 10** KRD three-dimensional nailing plate symbols and dimensions

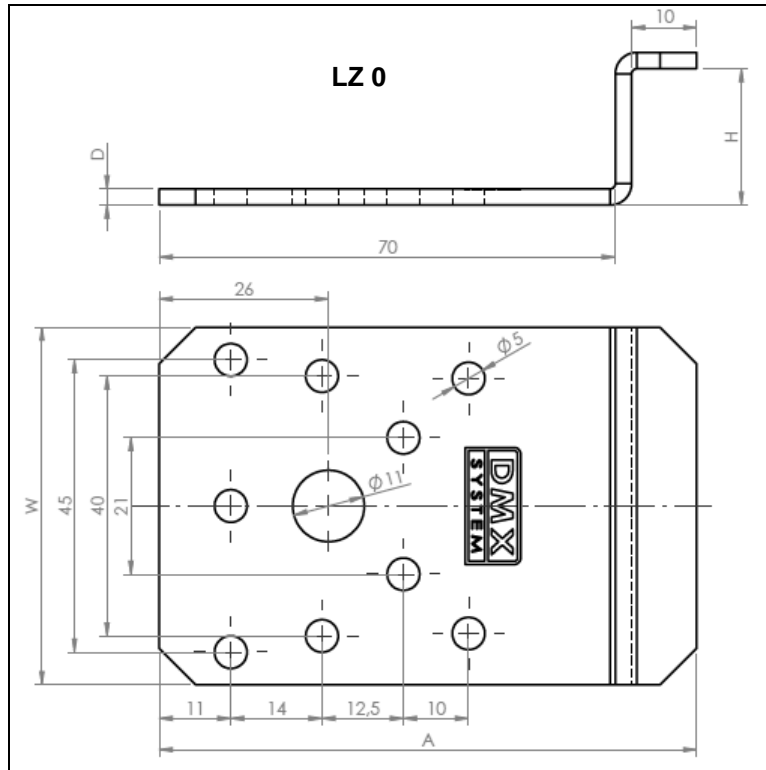
| Symbol | Dimensions [mm] |    |    |   | Quantity of openings |
|--------|-----------------|----|----|---|----------------------|
|        | W               | H  | B  | D | Ø 5                  |
| KRD 1  | 30              | 50 | 55 | 2 | 8                    |
| KRD 2  | 30              | 70 | 55 | 2 | 9                    |



**Figure 9** Type KRD

**Table 11** KRD three-dimensional nailing plate symbols and dimensions

| Symbol | Dimensions [mm] |     |    |   | Quantity of openings |
|--------|-----------------|-----|----|---|----------------------|
|        | W               | H   | B  | D | Ø 5                  |
| KRD 3  | 30              | 80  | 55 | 2 | 10                   |
| KRD 4  | 30              | 120 | 55 | 2 | 10                   |



**Figure 10** Type LZ

**Table 12** LZ three-dimensional nailing plate symbols and dimensions

| Symbol | Dimensions [mm] |    |      |     | Quantity of openings |      |
|--------|-----------------|----|------|-----|----------------------|------|
|        | W               | H  | A    | D   | Ø 5                  | Ø 11 |
| LZ 0   | 55              | 21 | 82.5 | 2.5 | 9                    | 1    |

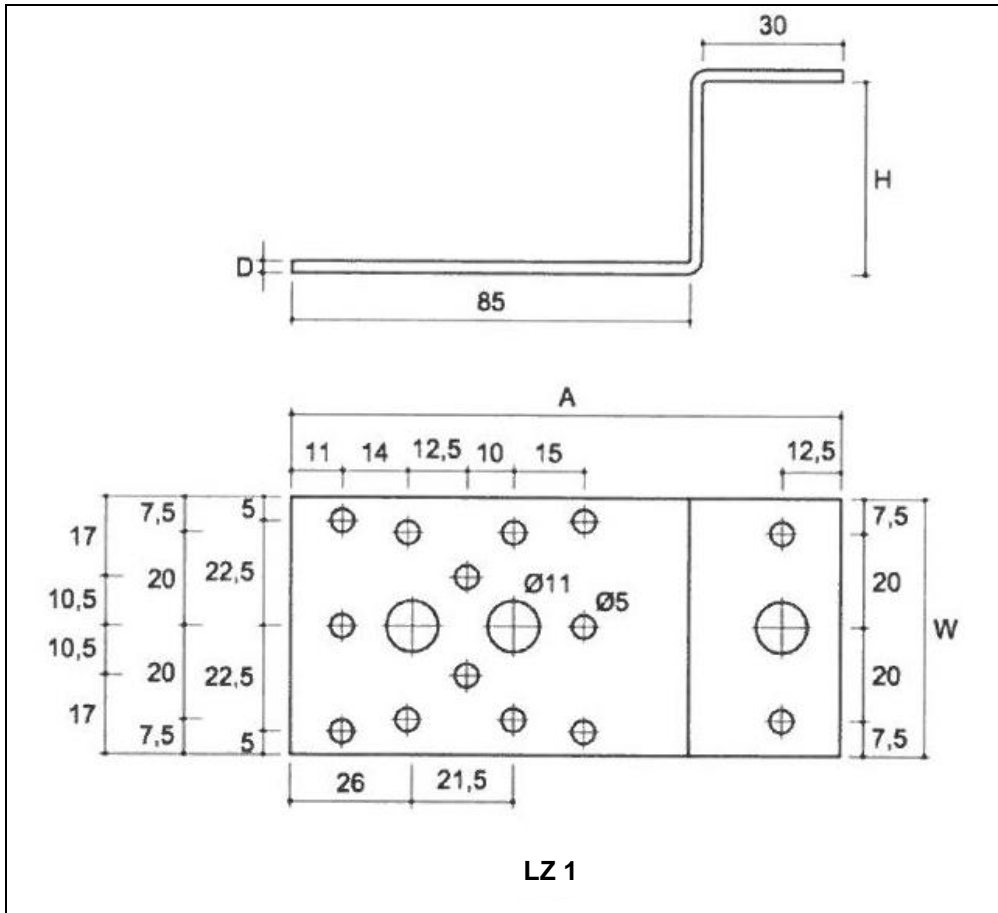
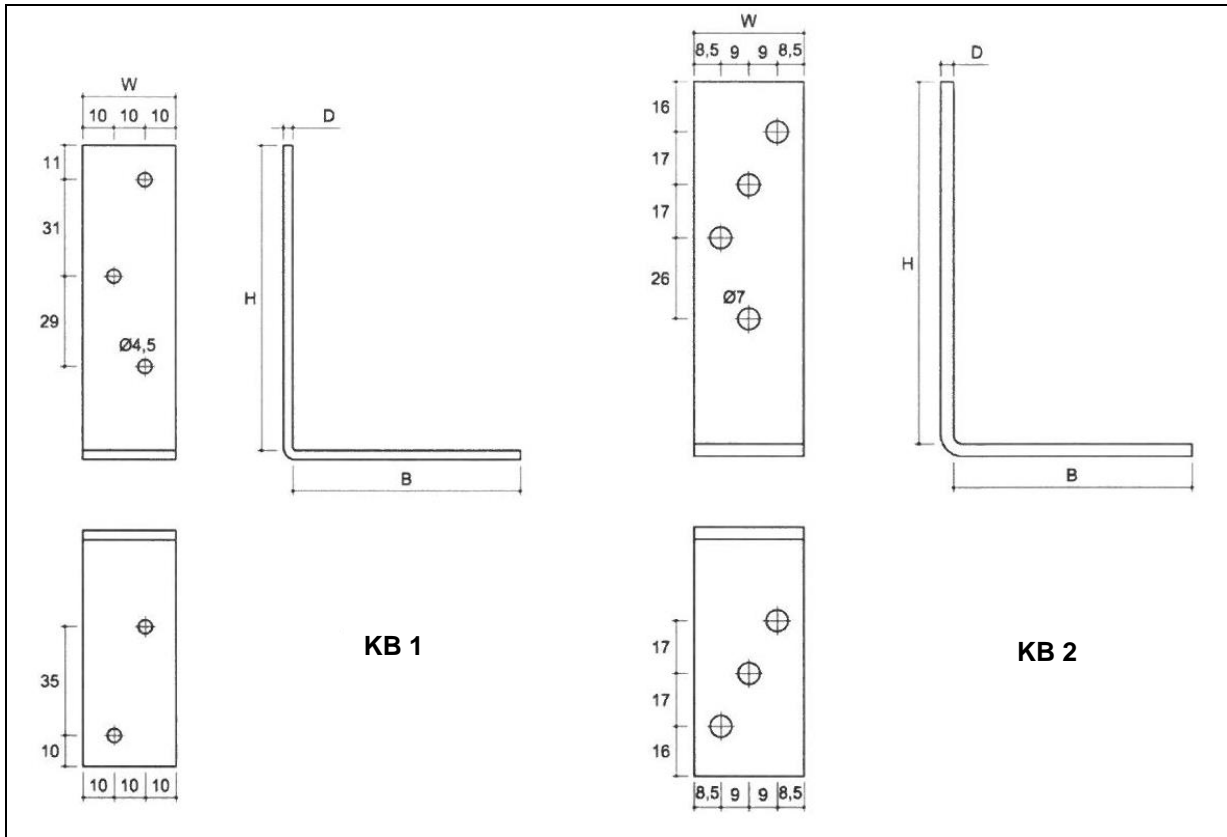


Figure 11 Type LZ

Table 13 LZ three-dimensional nailing plate symbols and dimensions

| Symbol | Dimensions [mm] |    |       |     | Quantity of openings |      |
|--------|-----------------|----|-------|-----|----------------------|------|
|        | W               | H  | A     | D   | Ø 5                  | Ø 11 |
| LZ 1   | 55              | 41 | 117.5 | 2.5 | 14                   | 3    |
| LZ 2   | 55              | 51 | 117.5 | 2.5 | 14                   | 3    |
| LZ 3   | 55              | 61 | 117.5 | 2.5 | 14                   | 3    |

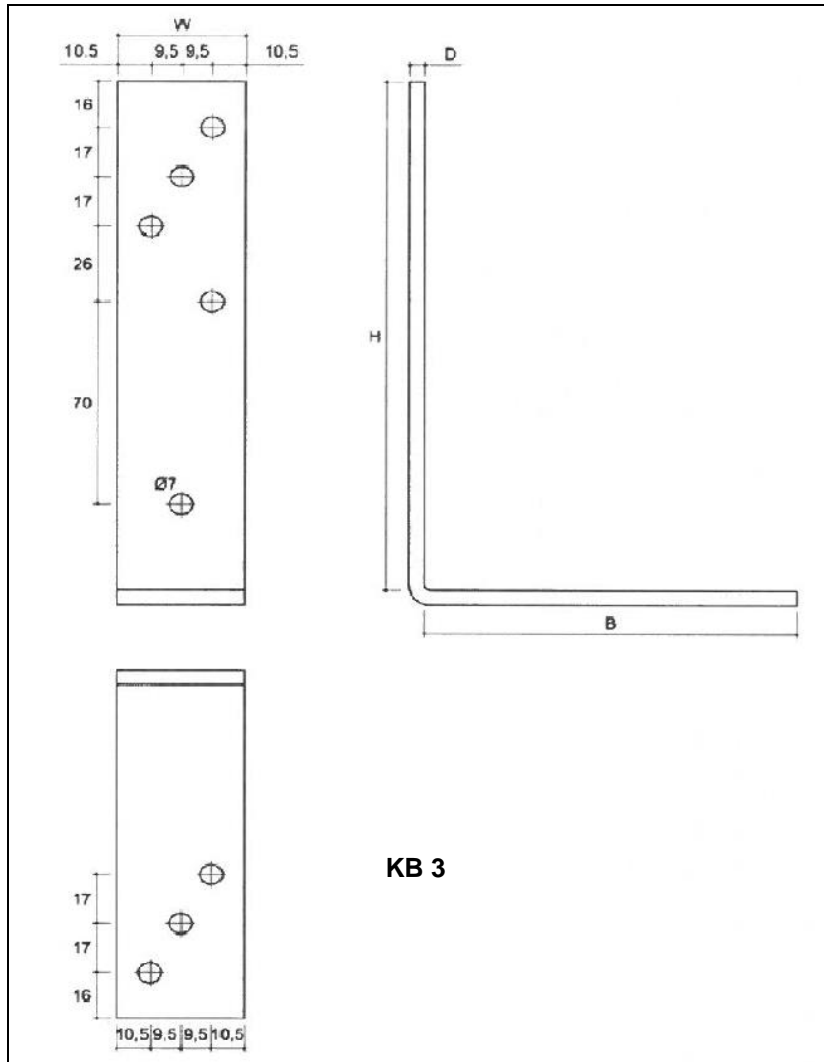


**Figure 12** Type KB

**Table 14** KB three-dimensional nailing plate symbols and dimensions

| Symbol | Dimensions [mm] |     |    |   | Quantity of openings |     |
|--------|-----------------|-----|----|---|----------------------|-----|
|        | W               | H   | B  | D | Ø 4.5                | Ø 7 |
| KB 1   | 30              | 98  | 73 | 3 | 5                    | -   |
| KB 2   | 35              | 116 | 76 | 4 | -                    | 7   |

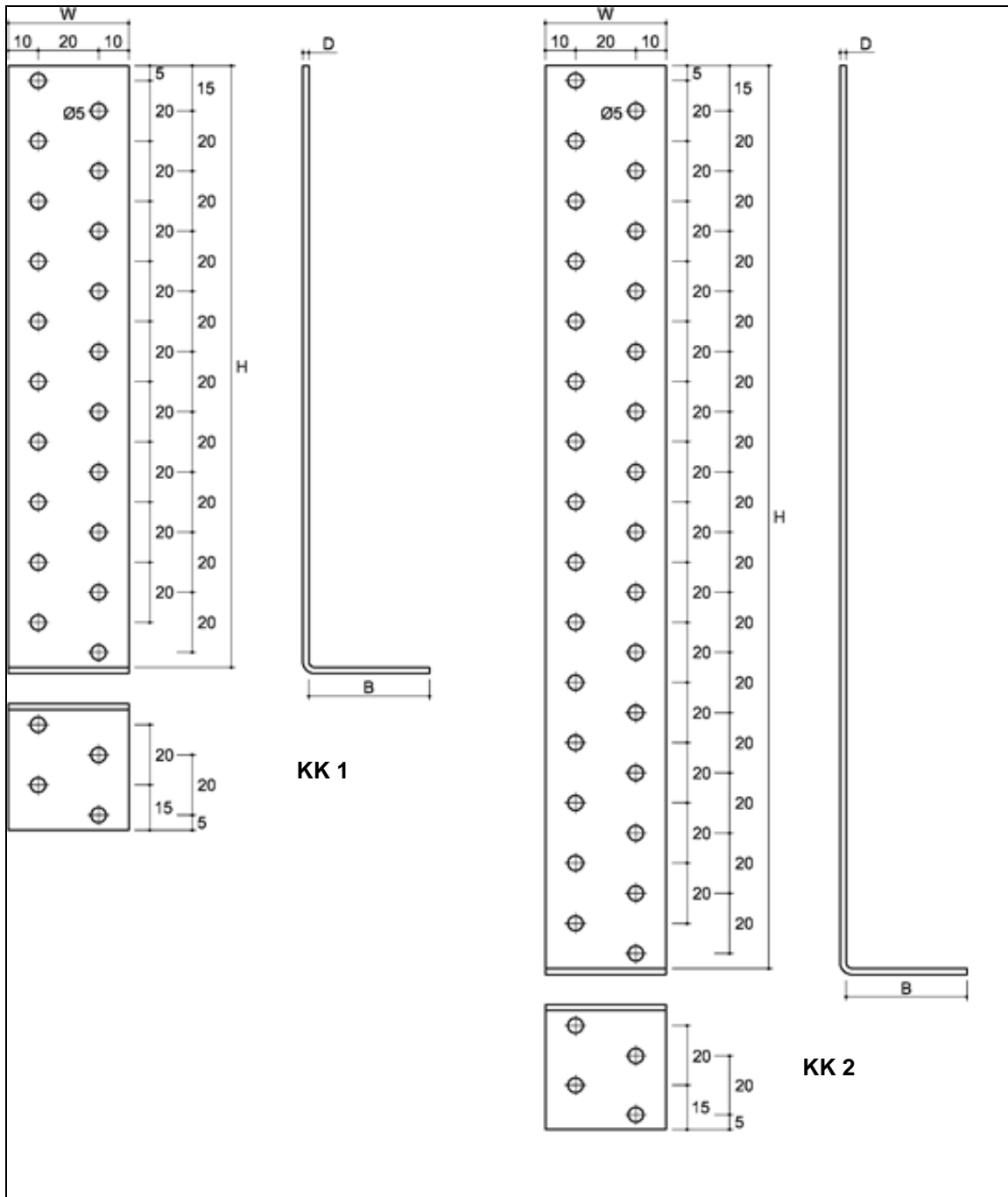




**Figure 13** Type KB

**Table 15** KB three-dimensional nailing plate symbols and dimensions

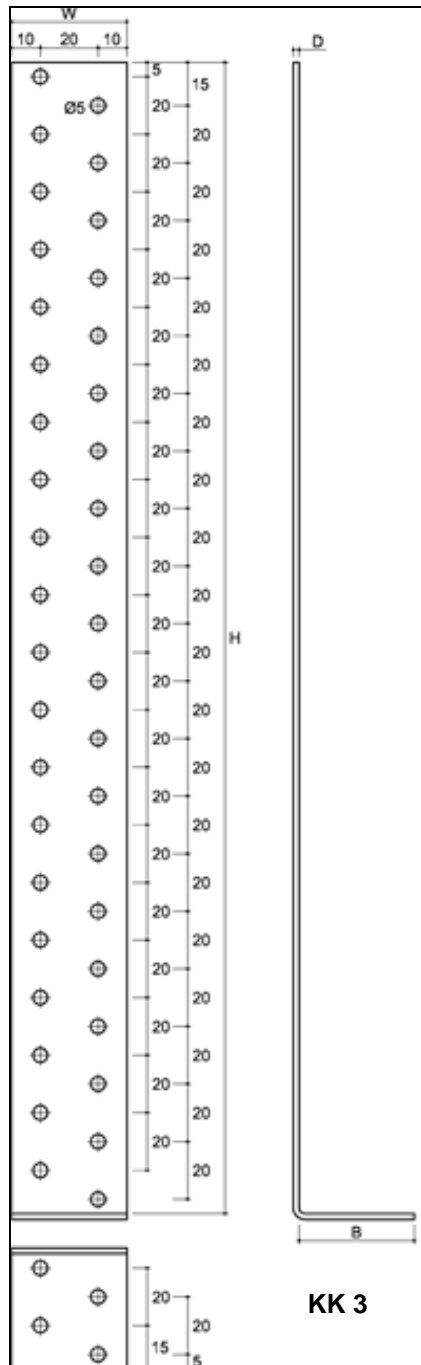
| Symbol | Dimensions [mm] |     |     |   | Quantity of openings |     |
|--------|-----------------|-----|-----|---|----------------------|-----|
|        | W               | H   | B   | D | Ø 4.5                | Ø 7 |
| KB 3   | 40              | 176 | 116 | 5 | -                    | 8   |



**Figure 14** Type KK

**Table 16** KK three-dimensional nailing plate symbols and dimensions

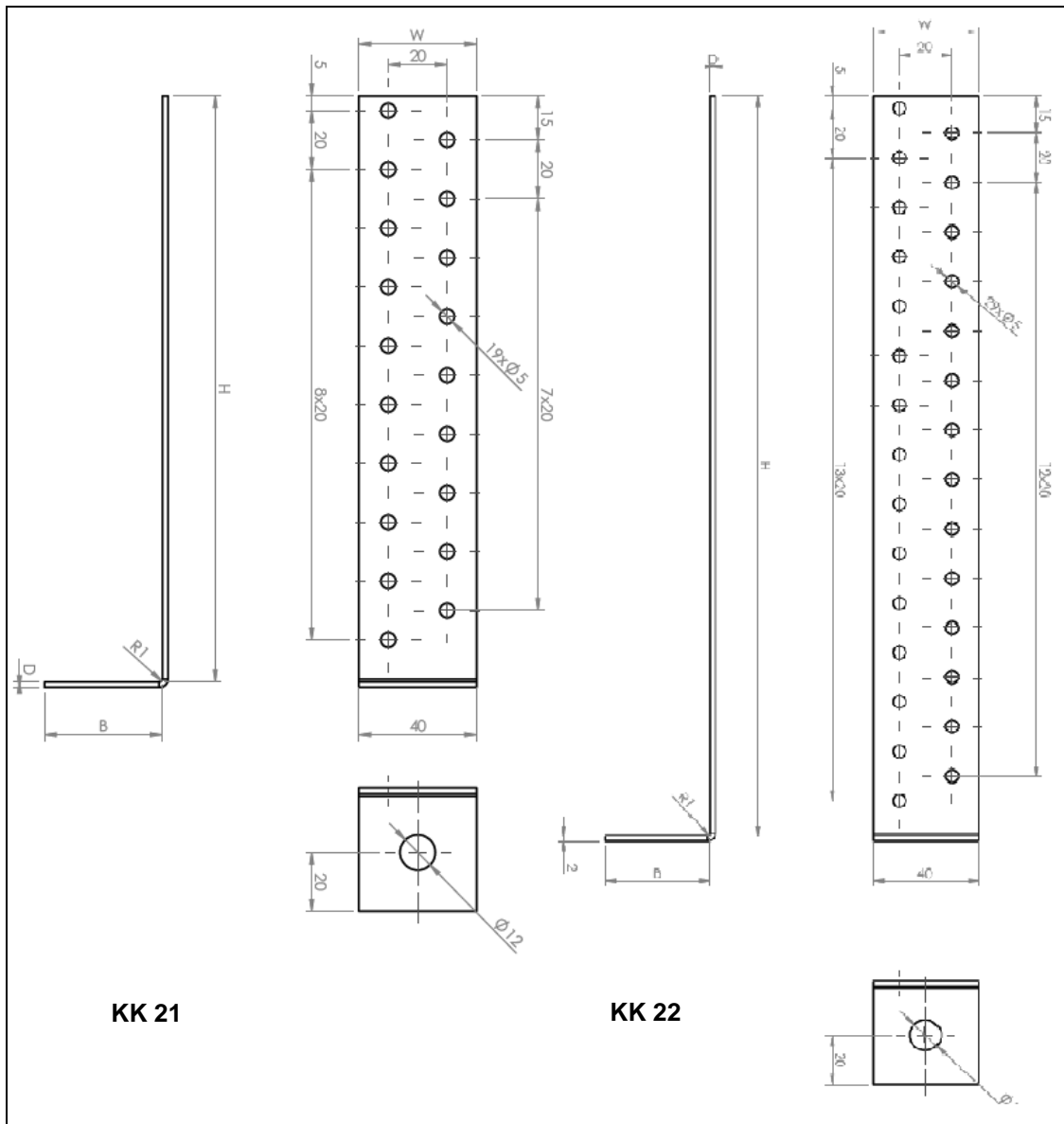
| Symbol | Dimensions [mm] |     |    |   | Quantity of openings |
|--------|-----------------|-----|----|---|----------------------|
|        | W               | H   | B  | D |                      |
| KK 1   | 40              | 200 | 40 | 2 | 24                   |
| KK 2   | 40              | 300 | 40 | 2 | 34                   |



**Figure 15** Type KK

**Table 17** KK three-dimensional nailing plate symbols and dimensions

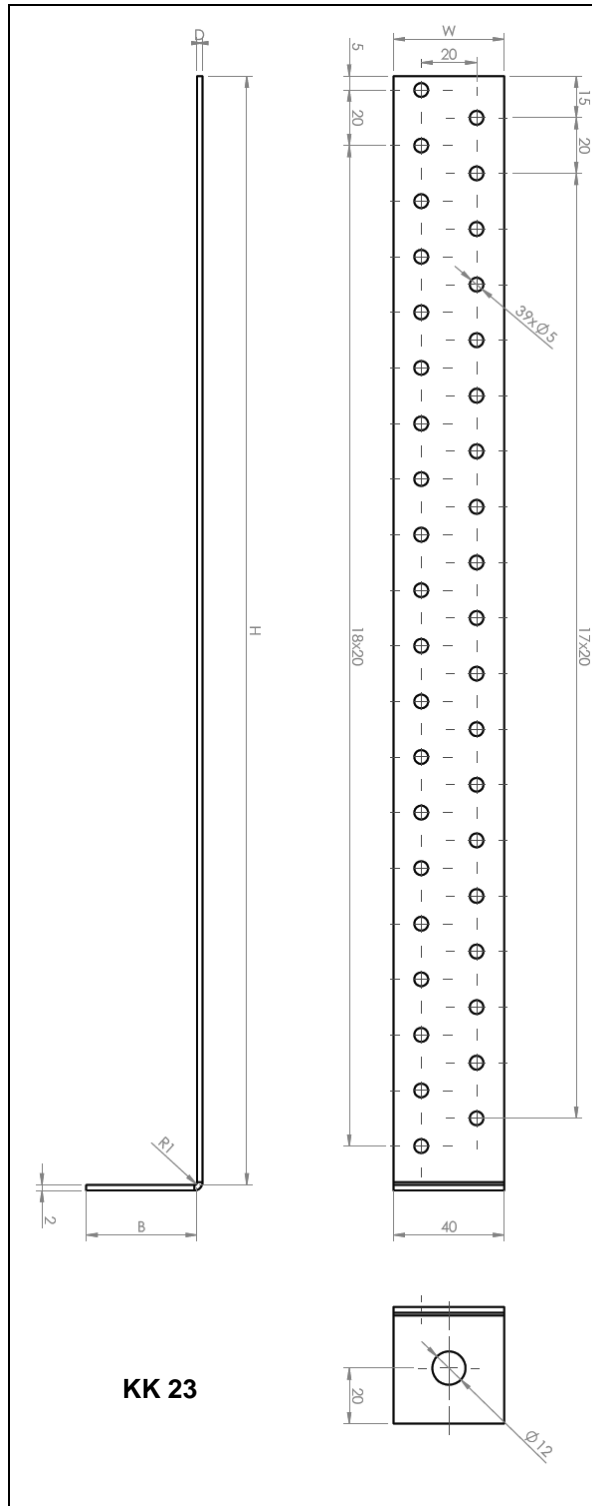
| Symbol | Dimensions [mm] |     |    |   | Quantity of openings |
|--------|-----------------|-----|----|---|----------------------|
|        | W               | H   | B  | D | Ø 5                  |
| KK 3   | 40              | 400 | 40 | 2 | 44                   |



**Figure 16** Type KK

**Table 18** KK three-dimensional nailing plate symbols and dimensions

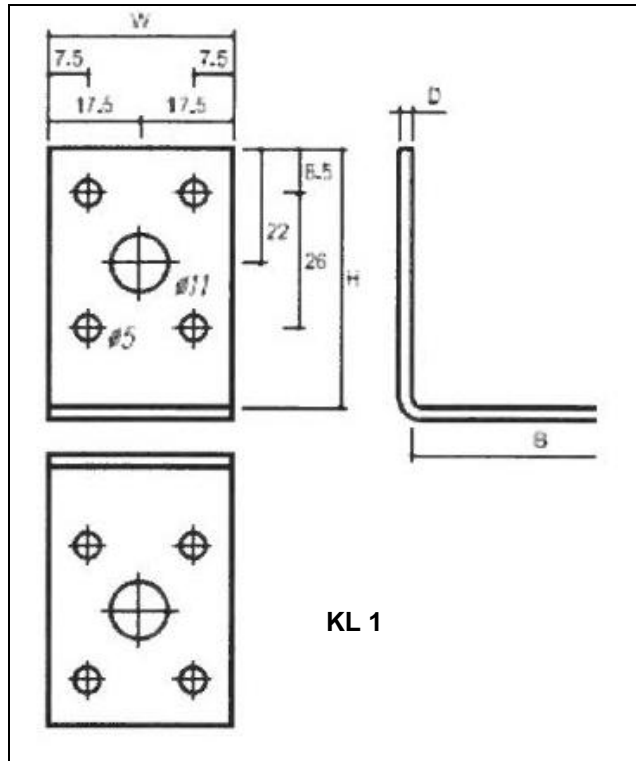
| Symbol | Dimensions [mm] |     |    |   | Quantity of openings |      |
|--------|-----------------|-----|----|---|----------------------|------|
|        | W               | H   | B  | D | Ø 5                  | Ø 12 |
| KK 21  | 40              | 200 | 40 | 2 | 19                   | 1    |
| KK 22  | 40              | 300 | 40 | 2 | 29                   | 1    |



**Figure 17** Type KK

**Table 19** KK three-dimensional nailing plate symbols and dimensions

| Symbol | Dimensions [mm] |     |    |   | Quantity of openings |      |
|--------|-----------------|-----|----|---|----------------------|------|
|        | W               | H   | B  | D | Ø 5                  | Ø 12 |
| KK 23  | 40              | 400 | 40 | 2 | 39                   | 1    |



**Figure 18** Type KL

**Table 20** KL three-dimensional nailing plate symbols and dimensions

| Symbol | Dimensions [mm] |    |    |     | Quantity of openings |     |      |     |
|--------|-----------------|----|----|-----|----------------------|-----|------|-----|
|        | W               | H  | B  | D   | Ø 5                  | Ø 7 | Ø 11 | Ø14 |
| KL 1   | 35              | 50 | 50 | 2.5 | 8                    | -   | 2    | -   |

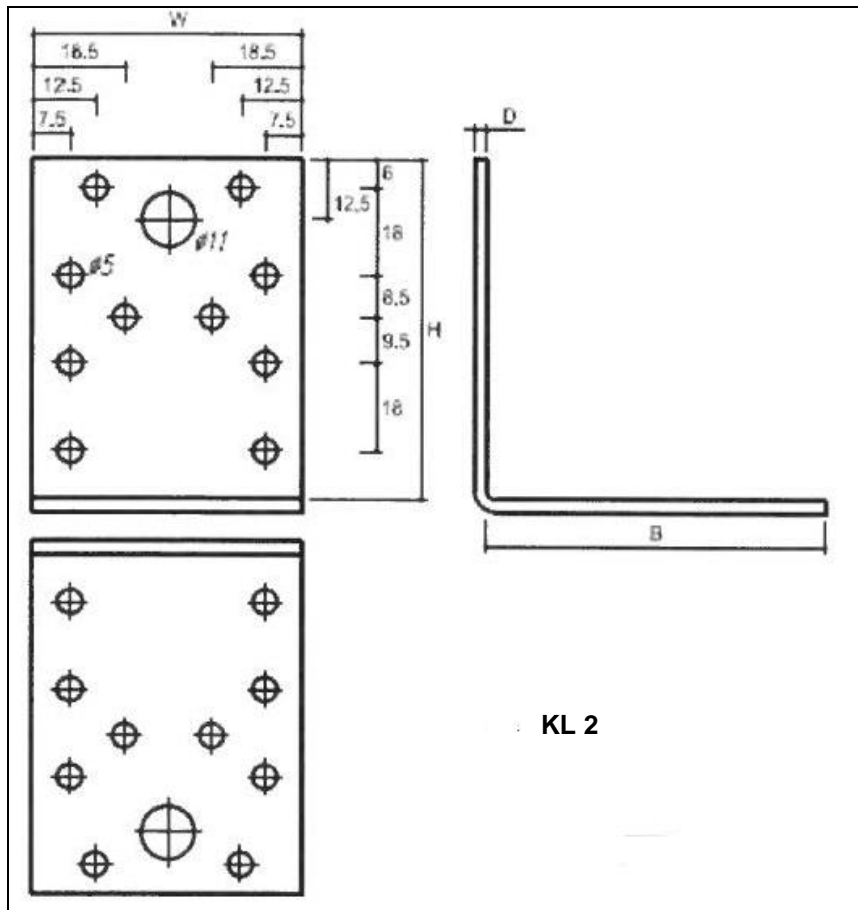


Figure 19 Type KL

Table 21 KL three-dimensional nailing plate symbols and dimensions

| Symbol | Dimensions [mm] |    |    |     | Quantity of openings |     |      |      |
|--------|-----------------|----|----|-----|----------------------|-----|------|------|
|        | W               | H  | B  | D   | Ø 5                  | Ø 7 | Ø 11 | Ø 14 |
| KL 2   | 55              | 70 | 70 | 2.5 | 20                   | -   | 2    | -    |

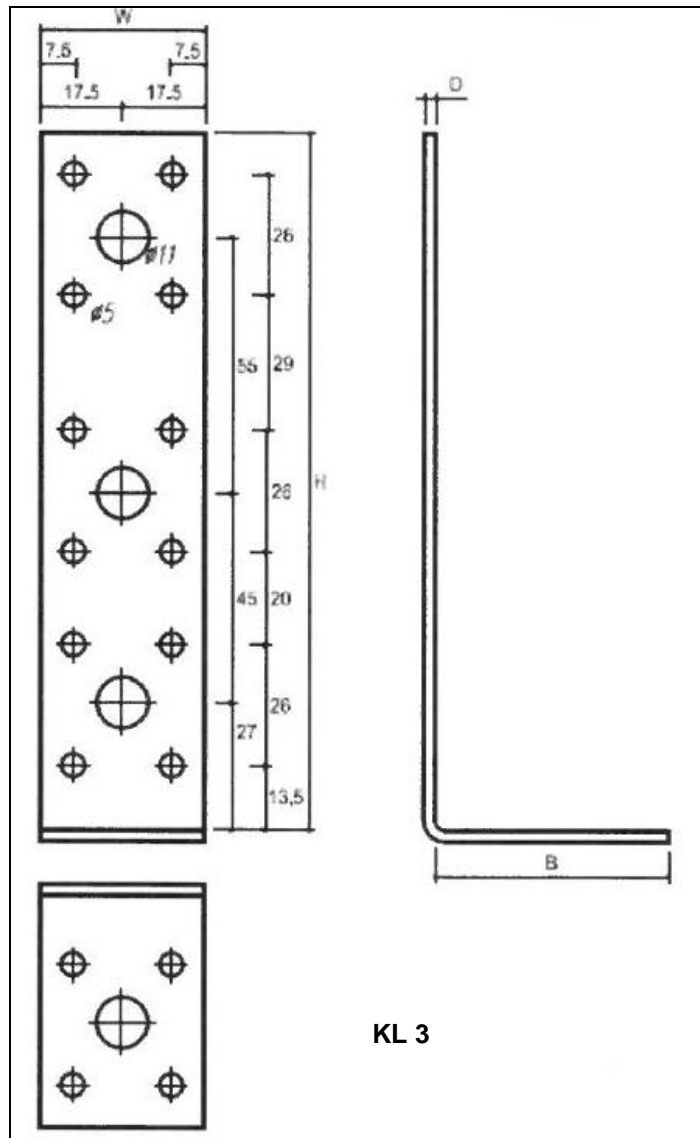
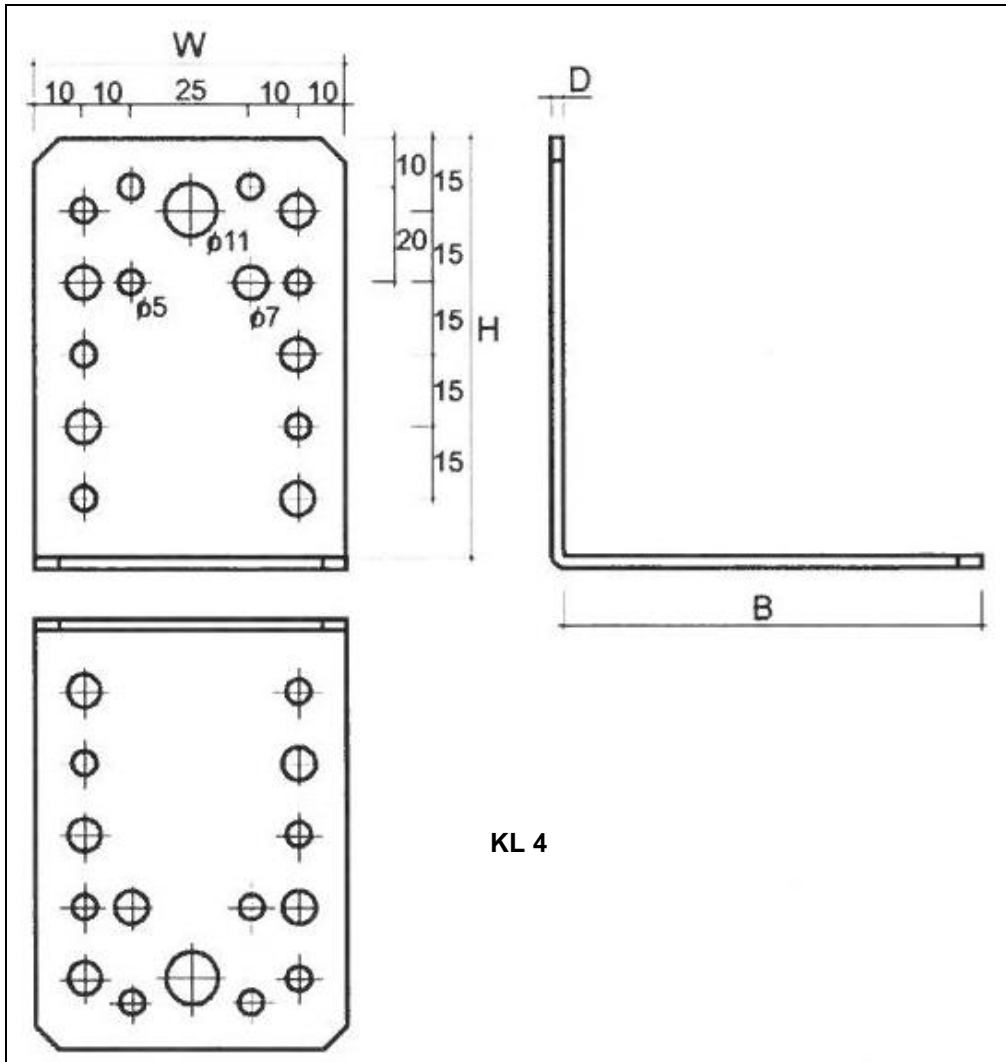


Figure 20 Type KL

Table 22 KL three-dimensional nailing plate symbols and dimensions

| Symbol | Dimensions [mm] |     |    |     | Quantity of openings |     |      |     |
|--------|-----------------|-----|----|-----|----------------------|-----|------|-----|
|        | W               | H   | B  | D   | Ø 5                  | Ø 7 | Ø 11 | Ø14 |
| KL 3   | 35              | 150 | 50 | 2.5 | 16                   | -   | 4    | -   |





**Figure 21** Type KL

**Table 23** KL three-dimensional nailing plate symbols and dimensions

| Symbol | Dimensions [mm] |    |    |     | Quantity of openings |          |           |           |
|--------|-----------------|----|----|-----|----------------------|----------|-----------|-----------|
|        | W               | H  | B  | D   | $\phi 5$             | $\phi 7$ | $\phi 11$ | $\phi 14$ |
| KL 4   | 65              | 90 | 90 | 2.5 | 16                   | 12       | 2         | -         |

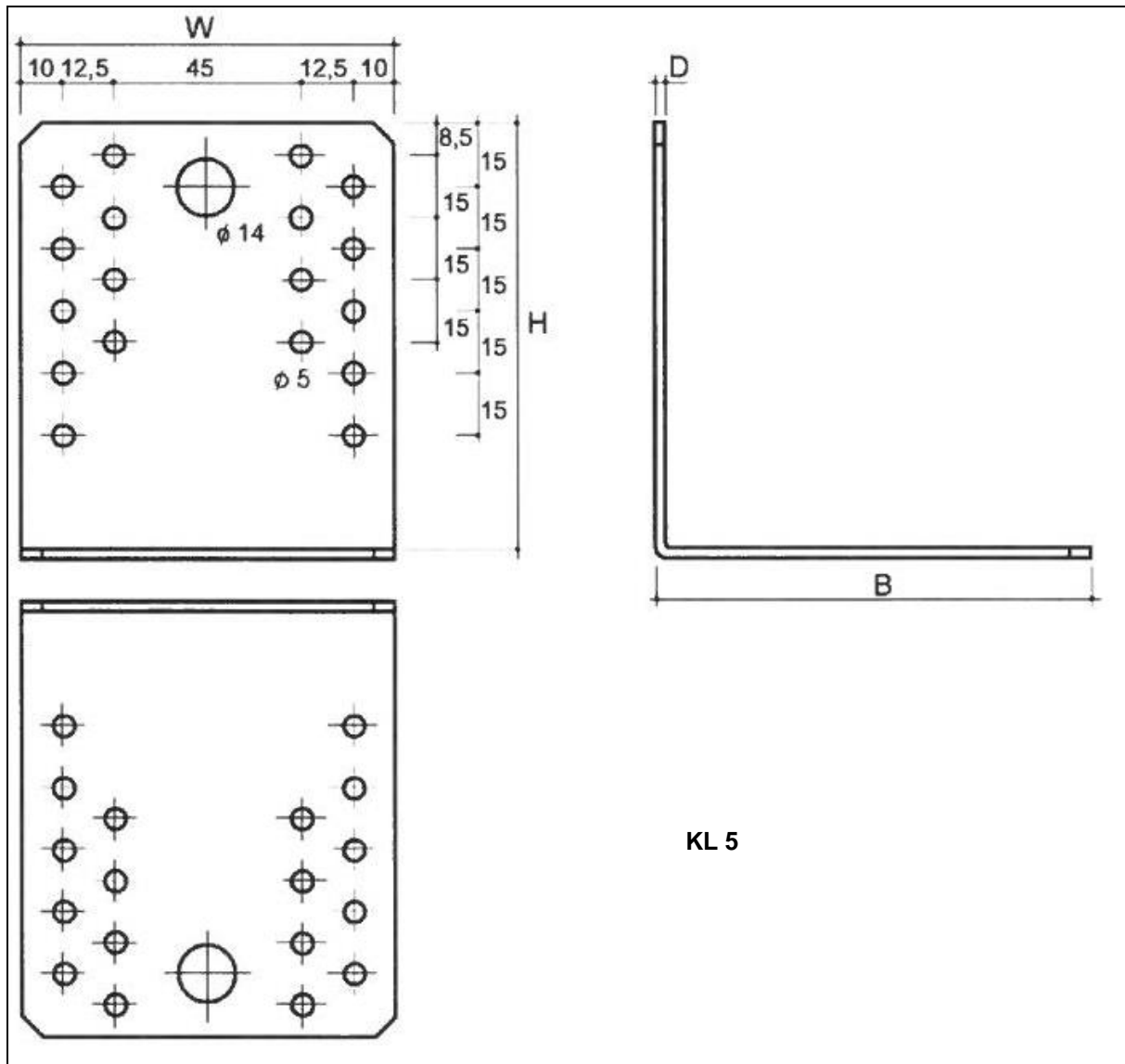
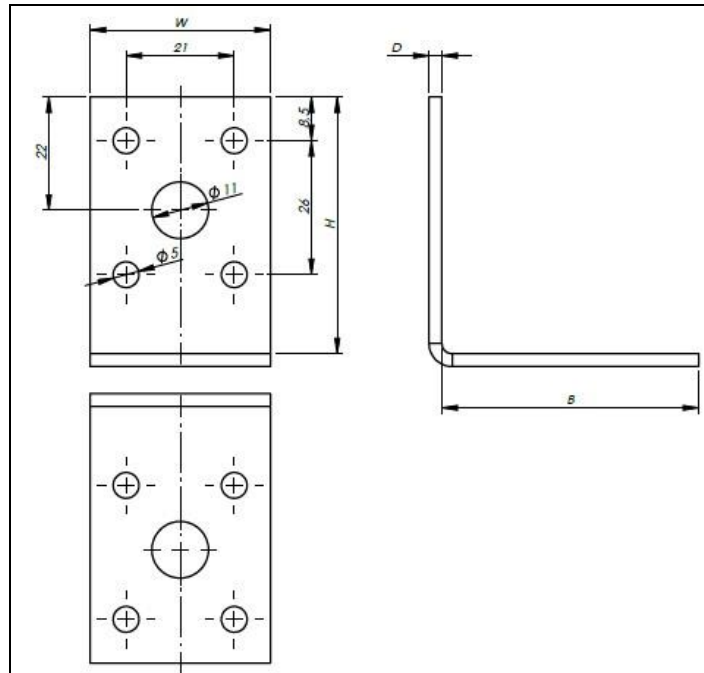


Figure 22 Type KL

Table 24 KL three-dimensional nailing plate symbols and dimensions

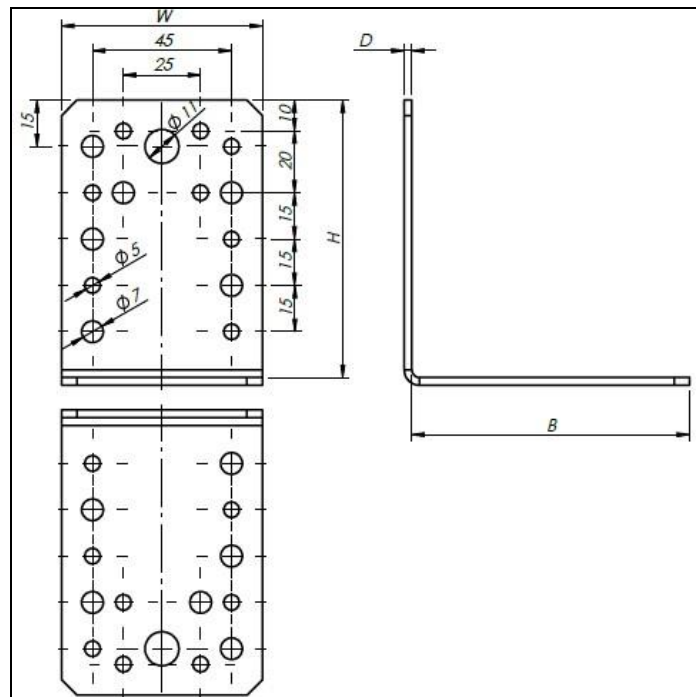
| Symbol | Dimensions [mm] |     |     |     | Quantity of openings |          |           |           |
|--------|-----------------|-----|-----|-----|----------------------|----------|-----------|-----------|
|        | W               | H   | B   | D   | $\phi 5$             | $\phi 7$ | $\phi 11$ | $\phi 14$ |
| KL 5   | 90              | 105 | 105 | 2.5 | 36                   | -        | -         | 2         |



**Figure 23** Type KL

**Table 25** KL three-dimensional nailing plate symbols and dimensions

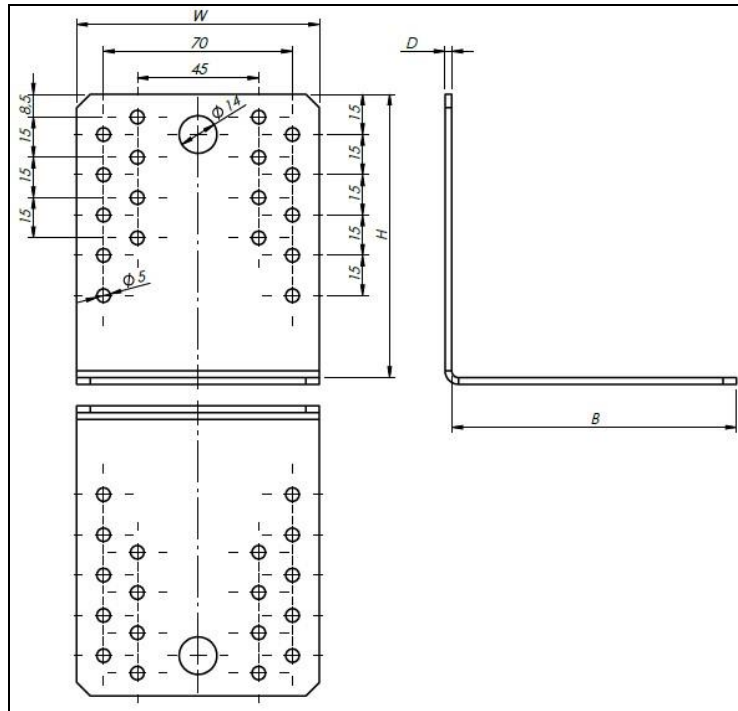
| Symbol | Dimensions [mm] |    |    |     | Quantity of openings |           |
|--------|-----------------|----|----|-----|----------------------|-----------|
|        | W               | H  | B  | D   | $\phi 5$             | $\phi 11$ |
| KL 101 | 35              | 50 | 50 | 2.0 | 8                    | 2         |



**Figure 24** Type KL

**Table 26** KL three-dimensional nailing plate symbols and dimensions

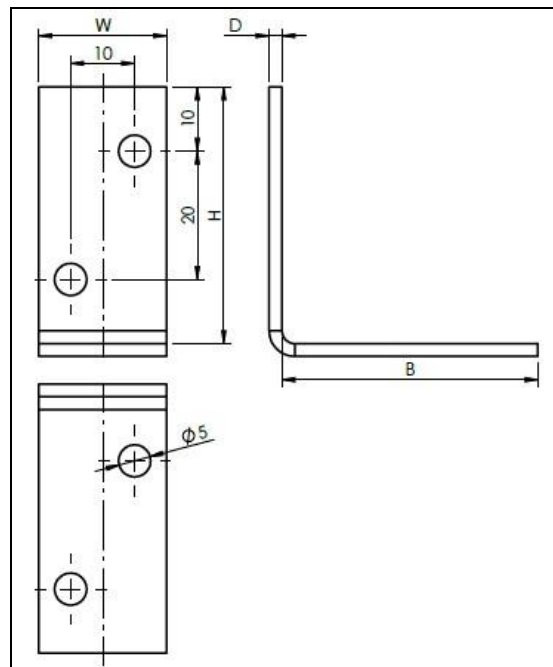
| Symbol | Dimensions [mm] |    |    |     | Quantity of openings |           |
|--------|-----------------|----|----|-----|----------------------|-----------|
|        | W               | H  | B  | D   | $\phi 5$             | $\phi 11$ |
| KL 104 | 65              | 90 | 90 | 2.0 | 16                   | 2         |



**Figure 25** Type KL

**Table 27** KL three-dimensional nailing plate symbols and dimensions

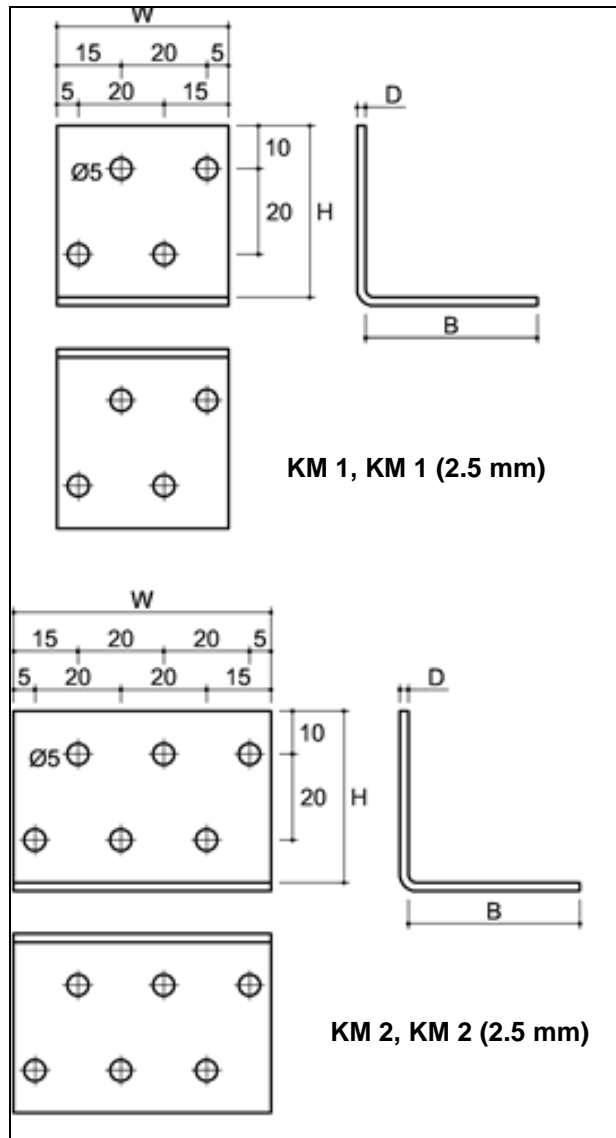
| Symbol | Dimensions [mm] |     |     |     | Quantity of openings |     |
|--------|-----------------|-----|-----|-----|----------------------|-----|
|        | W               | H   | B   | D   | Ø5                   | Ø14 |
| KL 105 | 90              | 105 | 105 | 2.0 | 36                   | 2   |



**Figure 26** Type KM

**Table 28** KM three-dimensional nailing plate symbols and dimensions

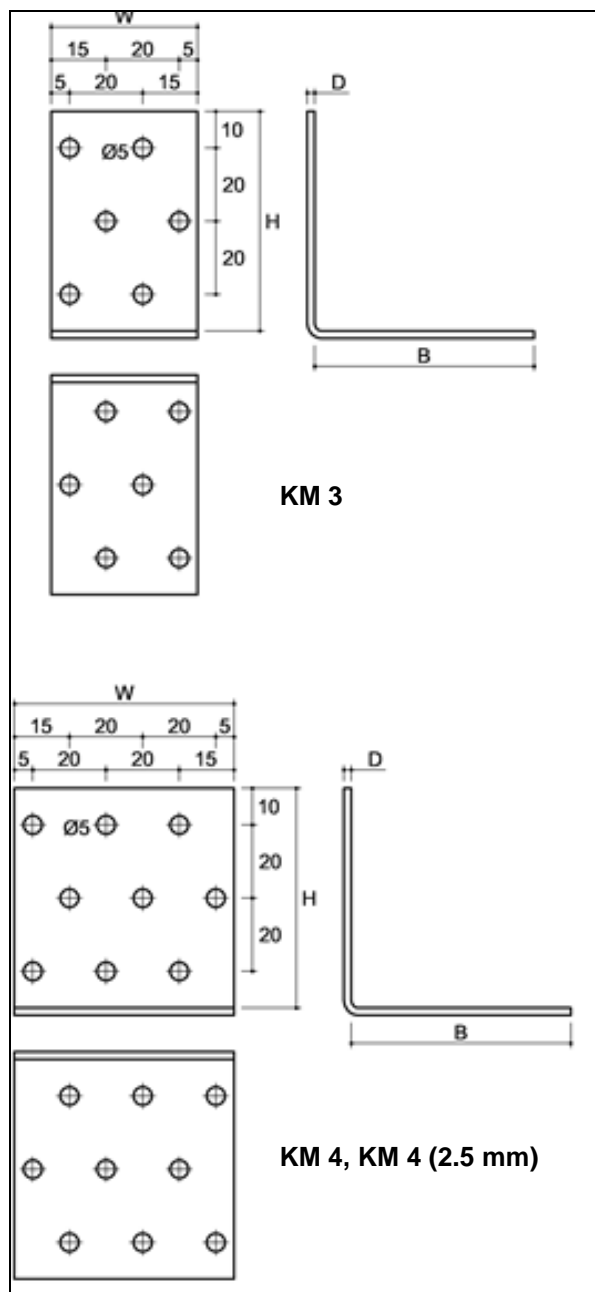
| Symbol | Dimensions [mm] |    |    |     | Quantity of openings |
|--------|-----------------|----|----|-----|----------------------|
|        | W               | H  | B  | D   | Ø5                   |
| KM 0   | 20              | 40 | 40 | 2.0 | 4                    |



**Figure 27** Type KM

**Table 29** KM three-dimensional nailing plate symbols and dimensions

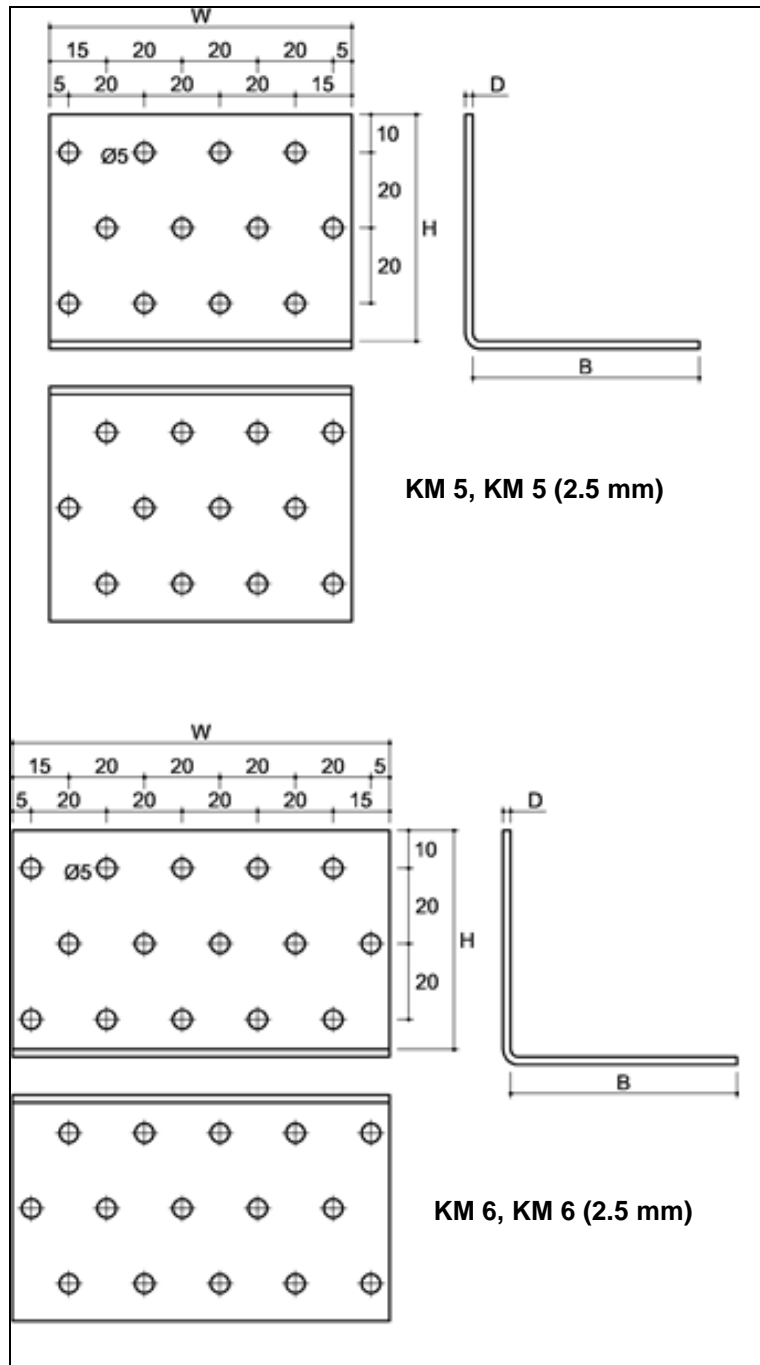
| Symbol        | Dimensions [mm] |    |    |     | Quantity of openings |
|---------------|-----------------|----|----|-----|----------------------|
|               | W               | H  | B  | D   | Ø 5                  |
| KM 1          | 40              | 40 | 40 | 2   | 8                    |
| KM 1 (2.5 mm) | 40              | 40 | 40 | 2.5 | 8                    |
| KM 2          | 60              | 40 | 40 | 2   | 12                   |
| KM 2 (2.5 mm) | 60              | 40 | 40 | 2.5 | 12                   |



**Figure 28** Type KM

**Table 30** KM three-dimensional nailing plate symbols and dimensions

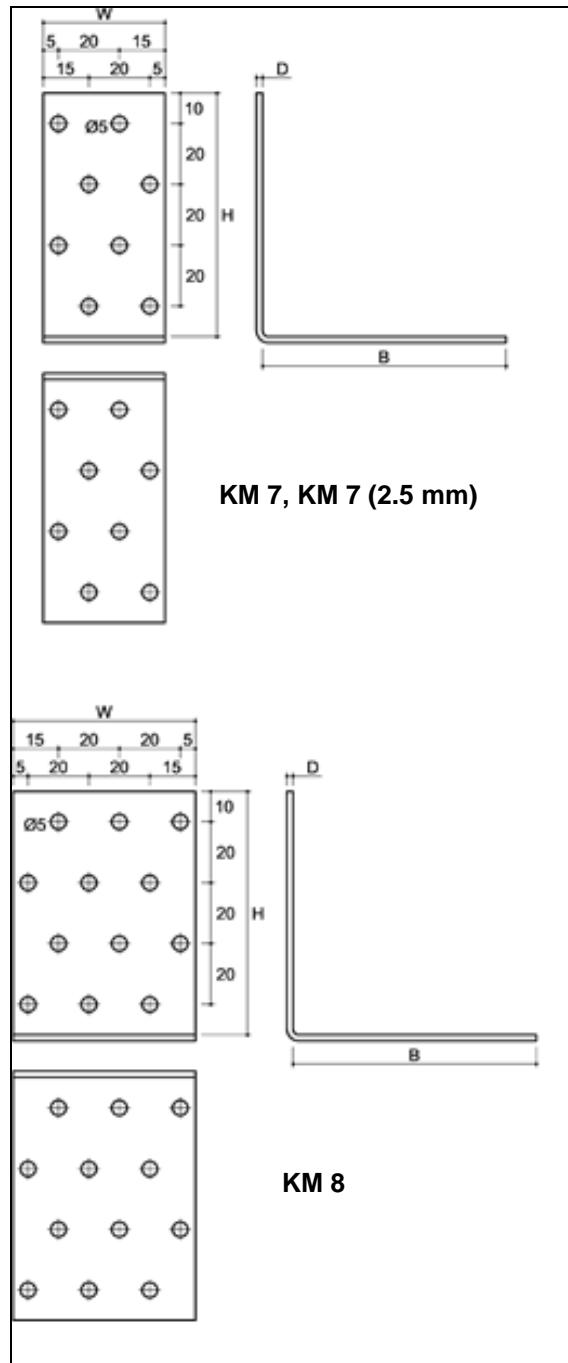
| Symbol        | Dimensions [mm] |    |    |     | Quantity of openings |
|---------------|-----------------|----|----|-----|----------------------|
|               | W               | H  | B  | D   | Ø 5                  |
| KM 3          | 40              | 60 | 60 | 2   | 12                   |
| KM 4          | 60              | 60 | 60 | 2   | 18                   |
| KM 4 (2.5 mm) | 60              | 60 | 60 | 2.5 | 18                   |



**Figure 29** Type KM

**Table 31** KM three-dimensional nailing plate symbols and dimensions

| Symbol        | Dimensions [mm] |    |    |     | Quantity of openings |
|---------------|-----------------|----|----|-----|----------------------|
|               | W               | H  | B  | D   | Ø 5                  |
| KM 5          | 80              | 60 | 60 | 2   | 24                   |
| KM 5 (2.5 mm) | 80              | 60 | 60 | 2.5 | 24                   |
| KM 6          | 100             | 60 | 60 | 2   | 30                   |
| KM 6 (2.5 mm) | 100             | 60 | 60 | 2.5 | 30                   |

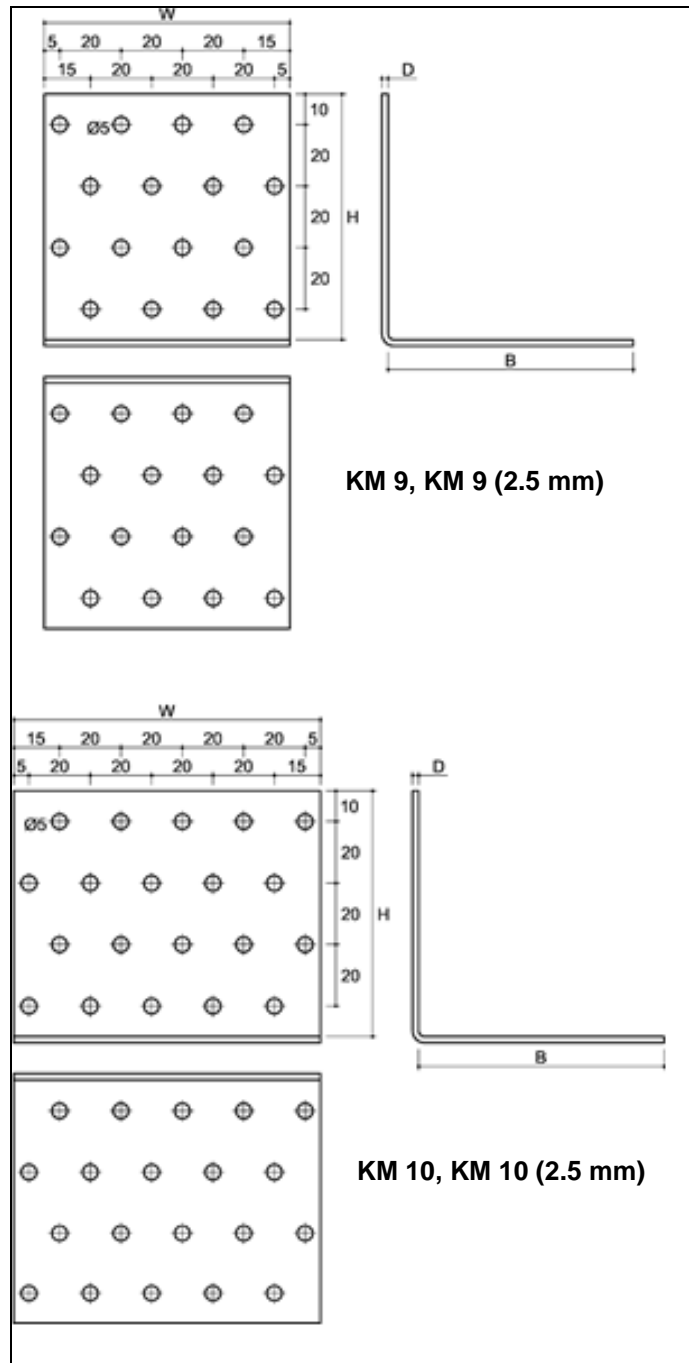


**Figure 30** Type KM

**Table 32** KM three-dimensional nailing plate symbols and dimensions

| Symbol        | Dimensions [mm] |    |    |     | Quantity of openings |
|---------------|-----------------|----|----|-----|----------------------|
|               | W               | H  | B  | D   |                      |
| KM 7          | 40              | 80 | 80 | 2   | 16                   |
| KM 7 (2.5 mm) | 40              | 80 | 80 | 2.5 | 16                   |
| KM 8          | 60              | 80 | 80 | 2   | 24                   |

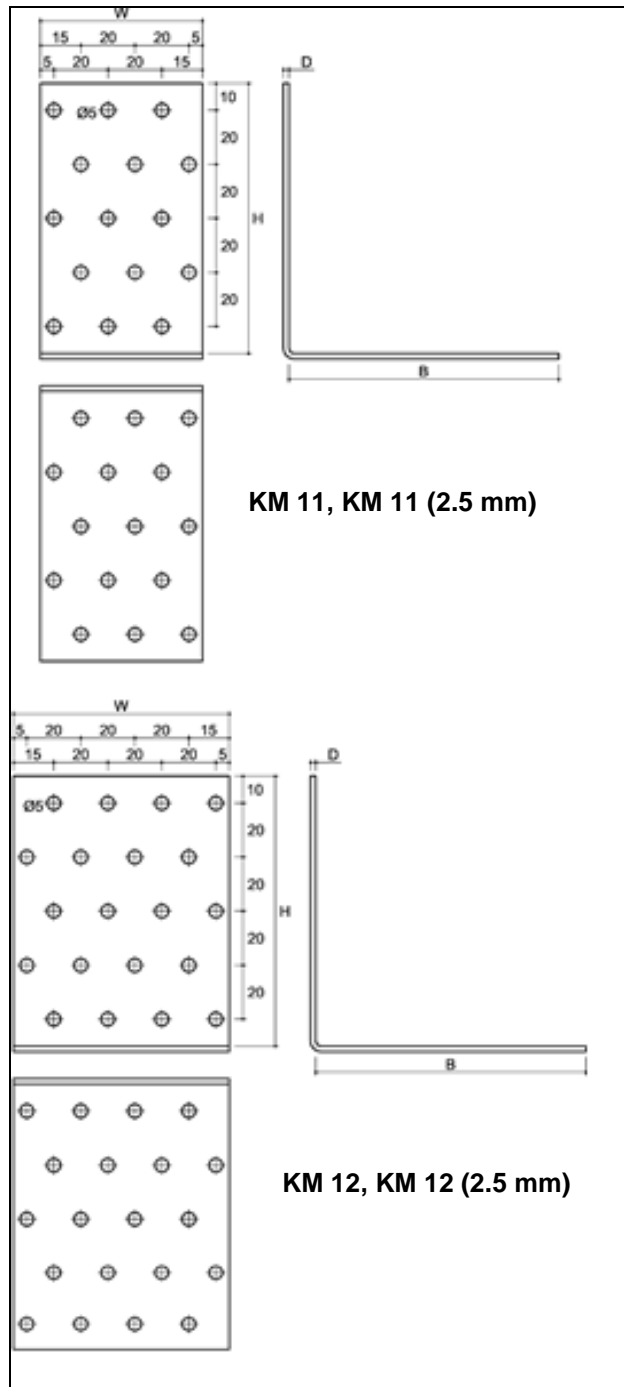




**Figure 31** Type KM

**Table 33** KM three-dimensional nailing plate symbols and dimensions

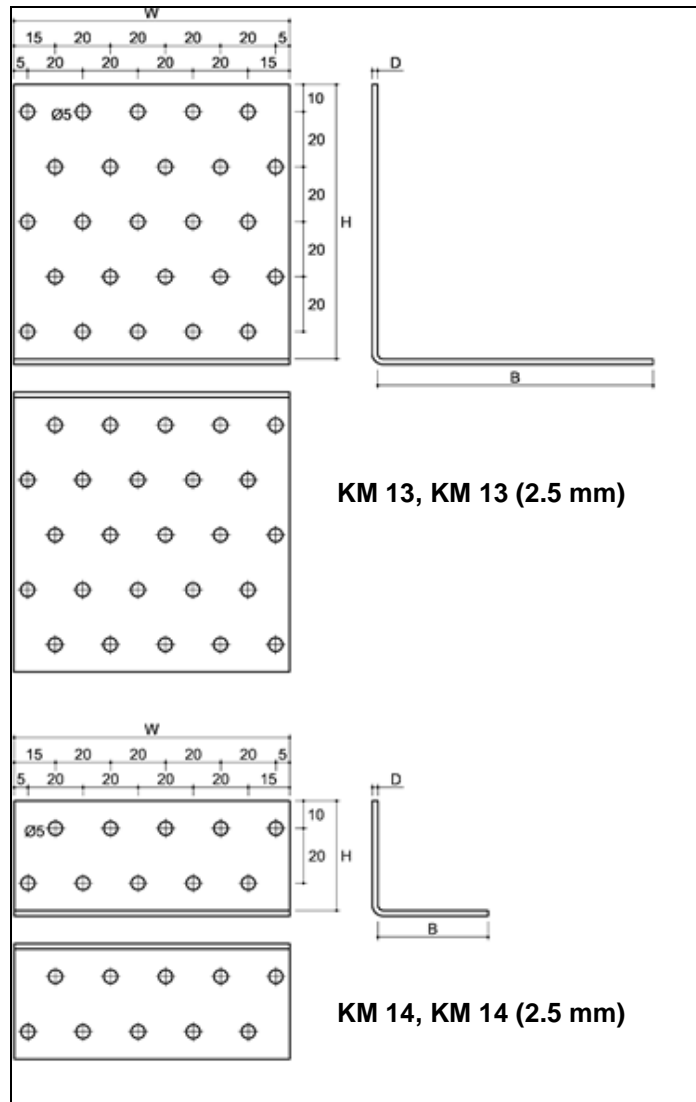
| Symbol        | Dimensions [mm] |    |    |     | Quantity of openings |
|---------------|-----------------|----|----|-----|----------------------|
|               | W               | H  | B  | D   |                      |
| KM 9          | 80              | 80 | 80 | 2   | 32                   |
| KM 9 (2.5 mm) | 80              | 80 | 80 | 2.5 | 32                   |
| KM 10         | 100             | 80 | 80 | 2   | 40                   |
| KM 10(2.5 mm) | 100             | 80 | 80 | 2.5 | 40                   |



**Figure 32** Type KM

**Table 34** KM three-dimensional nailing plate symbols and dimensions

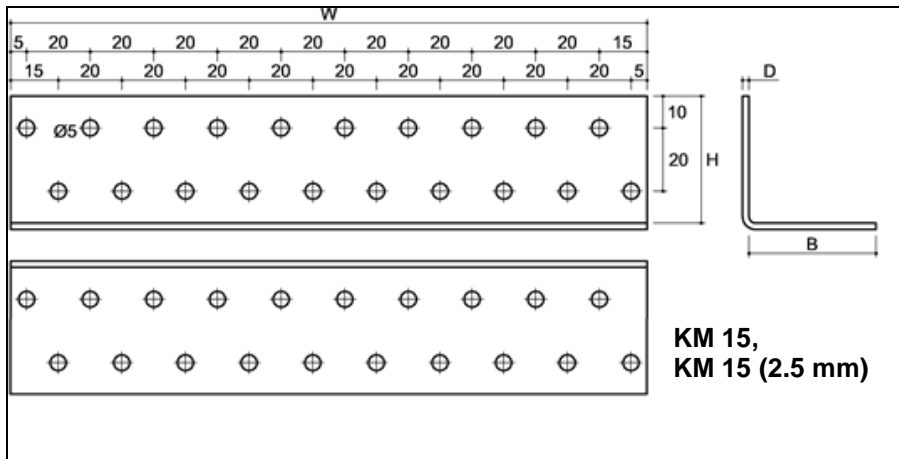
| Symbol         | Dimensions [mm] |     |     |     | Quantity of openings |
|----------------|-----------------|-----|-----|-----|----------------------|
|                | W               | H   | B   | D   | Ø 5                  |
| KM 11          | 60              | 100 | 100 | 2   | 30                   |
| KM 11 (2.5 mm) | 60              | 100 | 100 | 2.5 | 30                   |
| KM 12          | 80              | 100 | 100 | 2   | 40                   |
| KM 12 (2.5 mm) | 80              | 100 | 100 | 2.5 | 40                   |



**Figure 33** Type KM

**Table 35** KM three-dimensional nailing plate symbols and dimensions

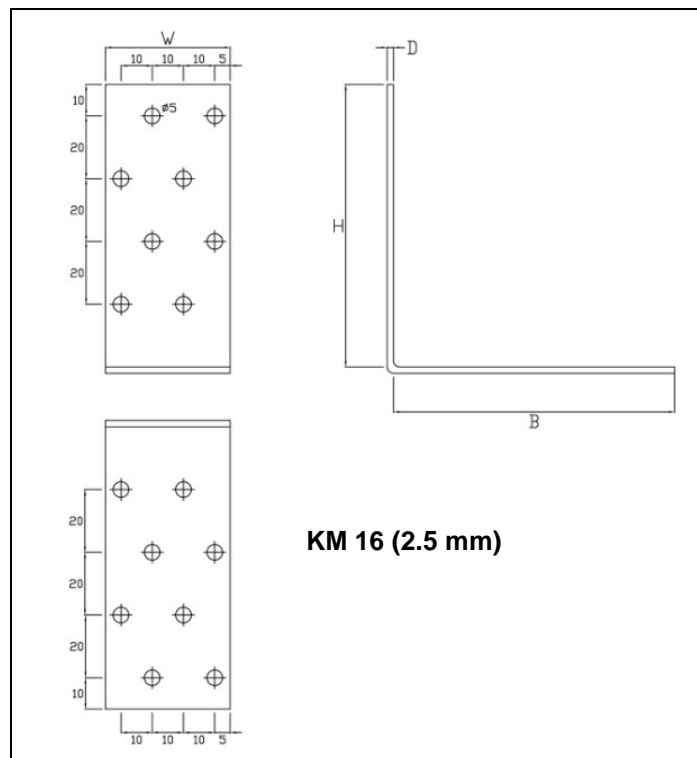
| Symbol         | Dimensions [mm] |     |     |     | Quantity of openings |
|----------------|-----------------|-----|-----|-----|----------------------|
|                | W               | H   | B   | D   | Ø 5                  |
| KM 13          | 100             | 100 | 100 | 2   | 50                   |
| KM 13 (2.5 mm) | 100             | 100 | 100 | 2.5 | 50                   |
| KM 14          | 100             | 40  | 40  | 2   | 20                   |
| KM 14 (2.5 mm) | 100             | 40  | 40  | 2.5 | 20                   |



**Figure 34** Type KM

**Table 36** KM three-dimensional nailing plate symbols and dimensions

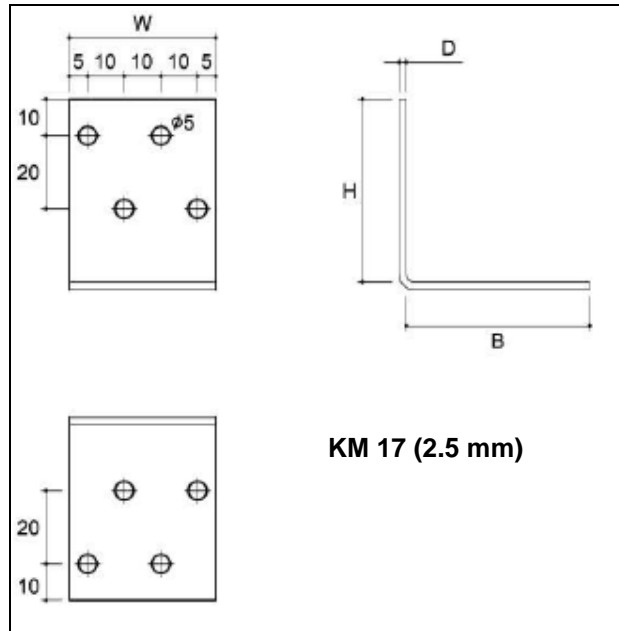
| Symbol         | Dimensions [mm] |    |    |     | Quantity of openings |
|----------------|-----------------|----|----|-----|----------------------|
|                | W               | H  | B  | D   | Ø 5                  |
| KM 15          | 200             | 40 | 40 | 2   | 40                   |
| KM 15 (2.5 mm) | 200             | 40 | 40 | 2.5 | 40                   |



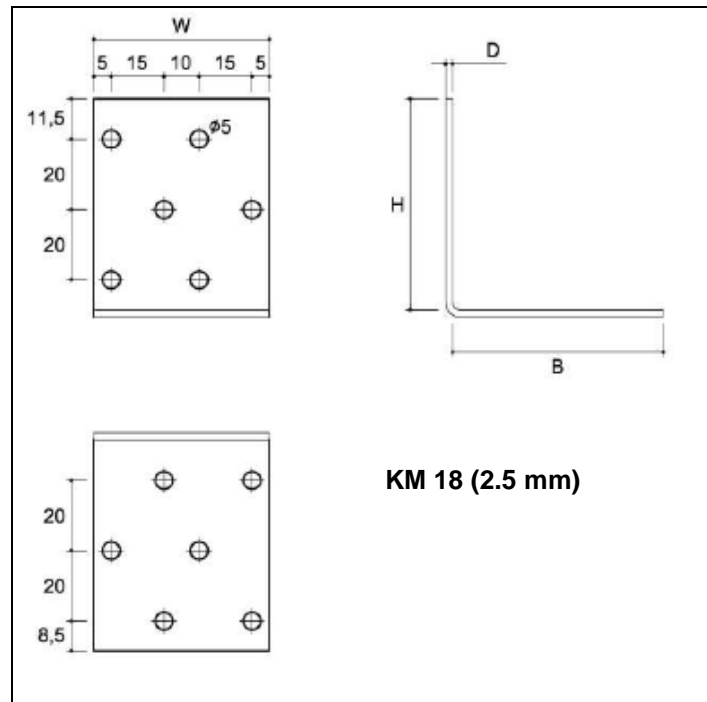
**Figure 35** Type KM

**Table 37** KM three-dimensional nailing plate symbols and dimensions

| Symbol         | Dimensions [mm] |    |    |     | Quantity of openings |
|----------------|-----------------|----|----|-----|----------------------|
|                | W               | H  | B  | D   | Ø 5                  |
| KM 16 (2.5 mm) | 40              | 90 | 90 | 2.5 | 16                   |



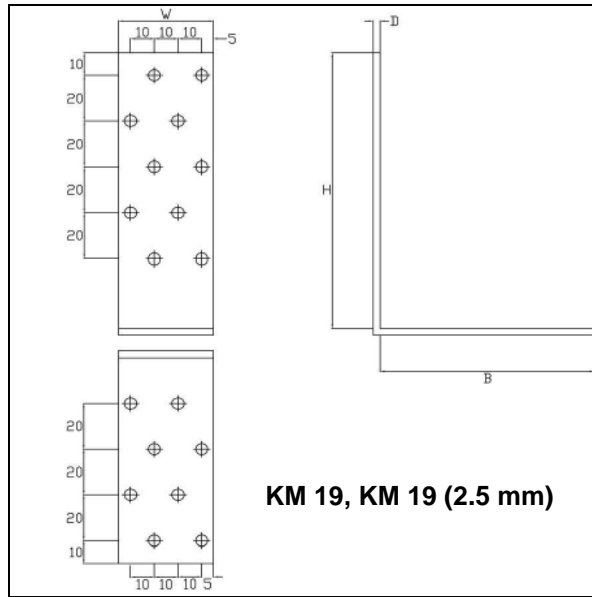
**Figure 36** Type KM



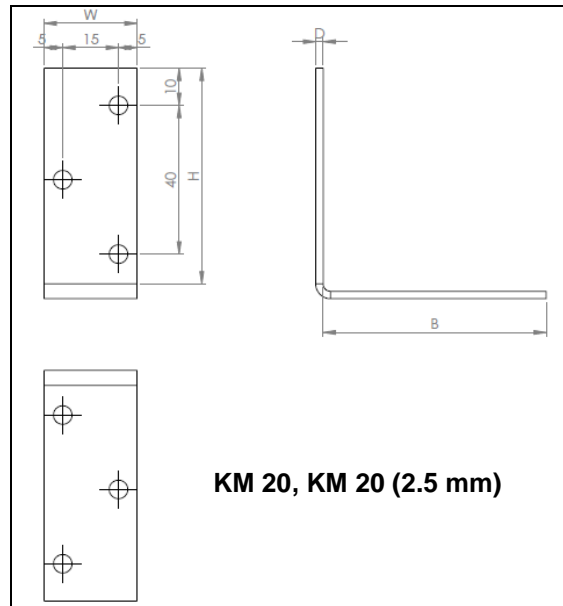
**Figure 37** Type KM

**Table 38** KM three-dimensional nailing plate symbols and dimensions

| Symbol         | Dimensions [mm] |    |    |     | Quantity of openings |
|----------------|-----------------|----|----|-----|----------------------|
|                | W               | H  | B  | D   |                      |
| KM 17 (2.5 mm) | 40              | 50 | 50 | 2.5 | 8                    |
| KM 18 (2.5 mm) | 50              | 60 | 60 | 2.5 | 12                   |



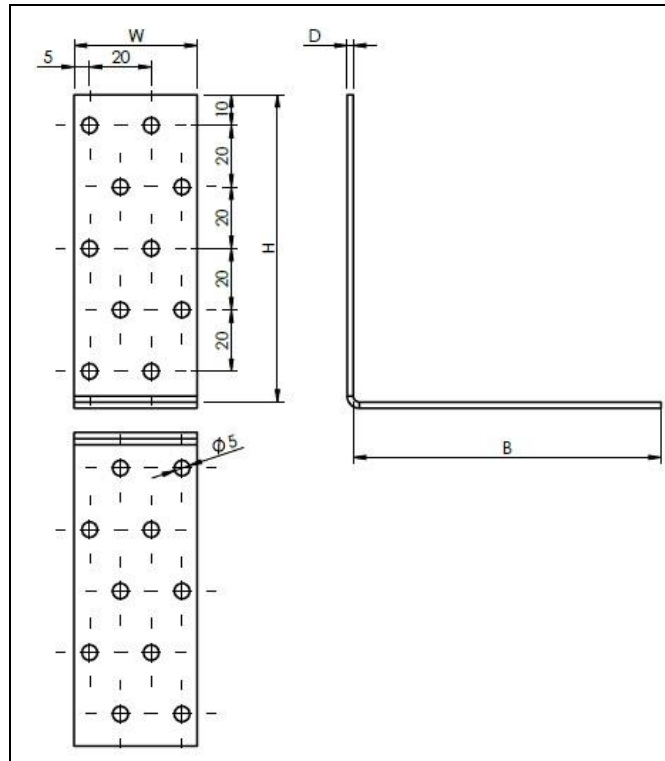
**Figure 38** Type KM



**Figure 39** Type KM

**Table 39** KM three-dimensional nailing plate symbols and dimensions

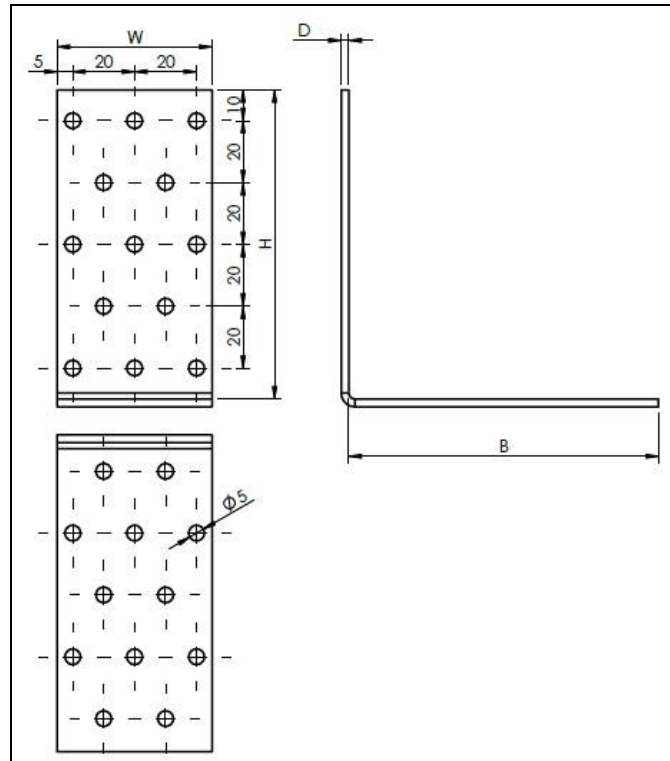
| Symbol         | Dimensions [mm] |     |    |     | Quantity of openings |
|----------------|-----------------|-----|----|-----|----------------------|
|                | W               | H   | B  | D   |                      |
| KM 19          | 40              | 120 | 90 | 2.0 | Ø 5                  |
| KM 19 (2.5 mm) | 40              | 120 | 90 | 2.5 | 18                   |
| KM 20          | 25              | 60  | 60 | 2.0 | 6                    |
| KM 20 (2.5 mm) | 25              | 60  | 60 | 2.5 | 6                    |



**Figure 40** Type KM

**Table 40** KM three-dimensional nailing plate symbols and dimensions

| Symbol | Dimensions [mm] |     |     |     | Quantity of openings |
|--------|-----------------|-----|-----|-----|----------------------|
|        | W               | H   | B   | D   | Ø5                   |
| KM 21  | 40              | 100 | 100 | 2.0 | 20                   |

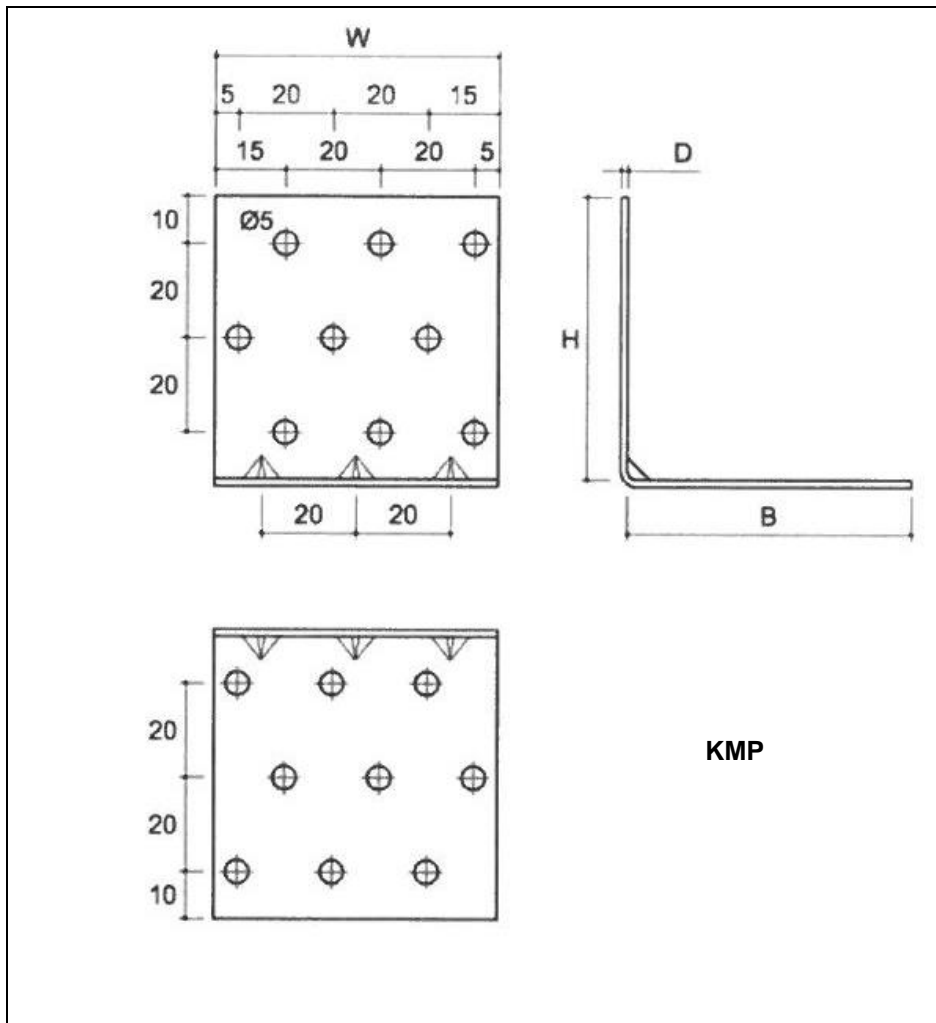


**Figure 41** Type KM

**Table 41** KM three-dimensional nailing plate symbols and dimensions

| Symbol         | Dimensions [mm] |     |     |     | Quantity of openings |
|----------------|-----------------|-----|-----|-----|----------------------|
|                | W               | H   | B   | D   | Ø5                   |
| KM 22 (2.5 mm) | 50              | 100 | 100 | 2.5 | 25                   |

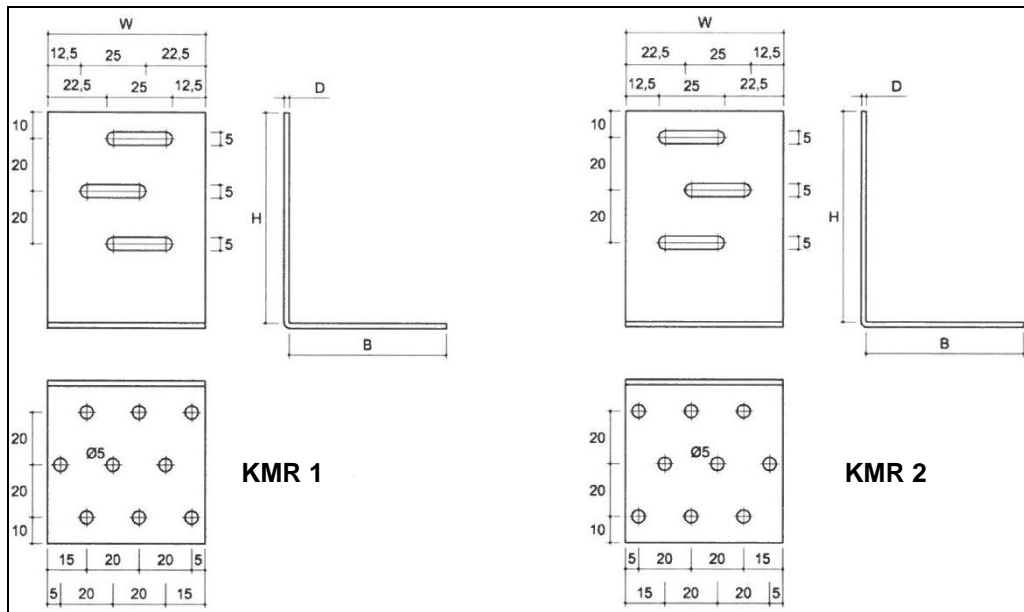




**Figure 42** Type KMP

**Table 42** KMP three-dimensional nailing plate symbols and dimensions

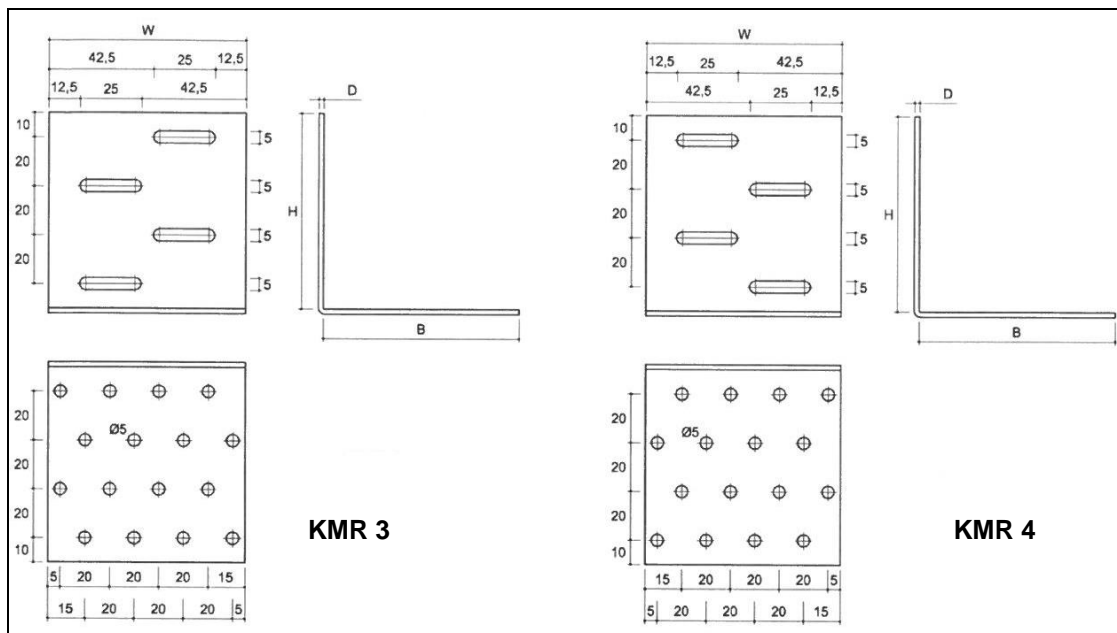
| Symbol | Dimensions [mm] |    |    |     | Quantity of openings |
|--------|-----------------|----|----|-----|----------------------|
|        | W               | H  | B  | D   | Ø 5                  |
| KMP1   | 40              | 40 | 40 | 1.5 | 8                    |
| KMP2   | 60              | 40 | 40 | 1.5 | 12                   |
| KMP3   | 80              | 40 | 40 | 1.5 | 16                   |
| KMP4   | 40              | 60 | 60 | 1.5 | 12                   |
| KMP5   | 60              | 60 | 60 | 1.5 | 18                   |
| KMP6   | 80              | 60 | 60 | 1.5 | 24                   |
| KMP7   | 40              | 80 | 80 | 1.5 | 16                   |
| KMP8   | 60              | 80 | 80 | 1.5 | 24                   |
| KMP9   | 80              | 80 | 80 | 1.5 | 32                   |



**Figure 43** Type KMR

**Table 43** KMR three-dimensional nailing plate symbols and dimensions

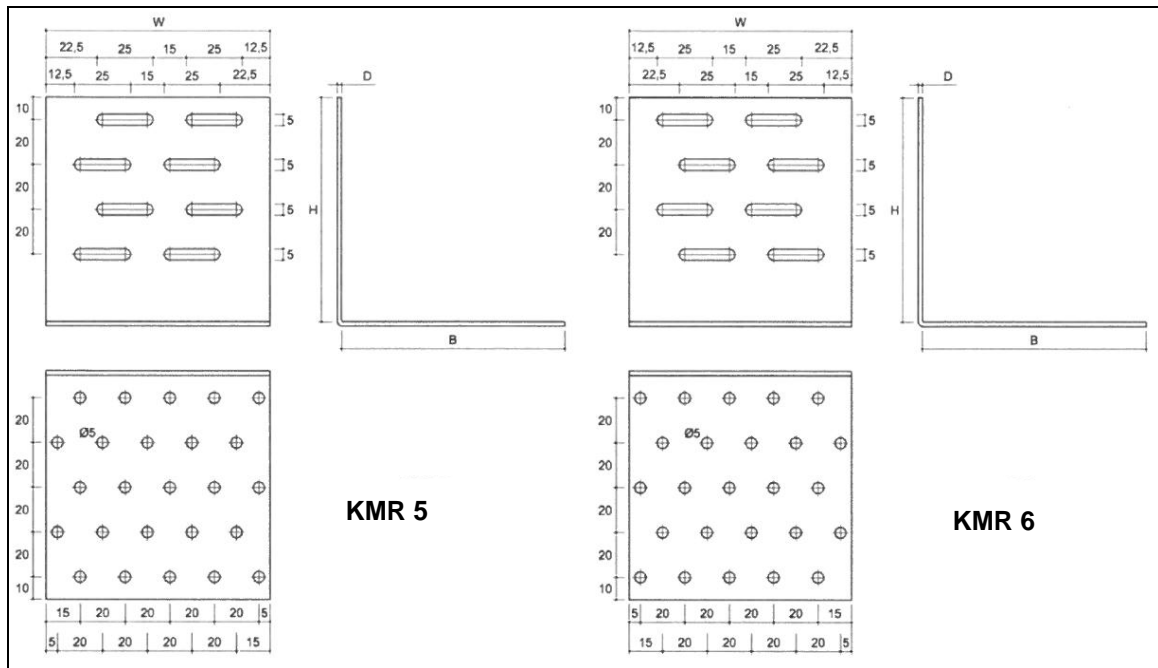
| Symbol | Dimensions [mm] |    |    |   | Quantity of openings |
|--------|-----------------|----|----|---|----------------------|
|        | W               | H  | B  | D | Ø 5                  |
| KMR 1  | 60              | 80 | 60 | 2 | 9                    |
| KMR 2  | 60              | 80 | 60 | 2 | 9                    |



**Figure 44** Type KMR

**Table 44** KMR three-dimensional nailing plate symbols and dimensions

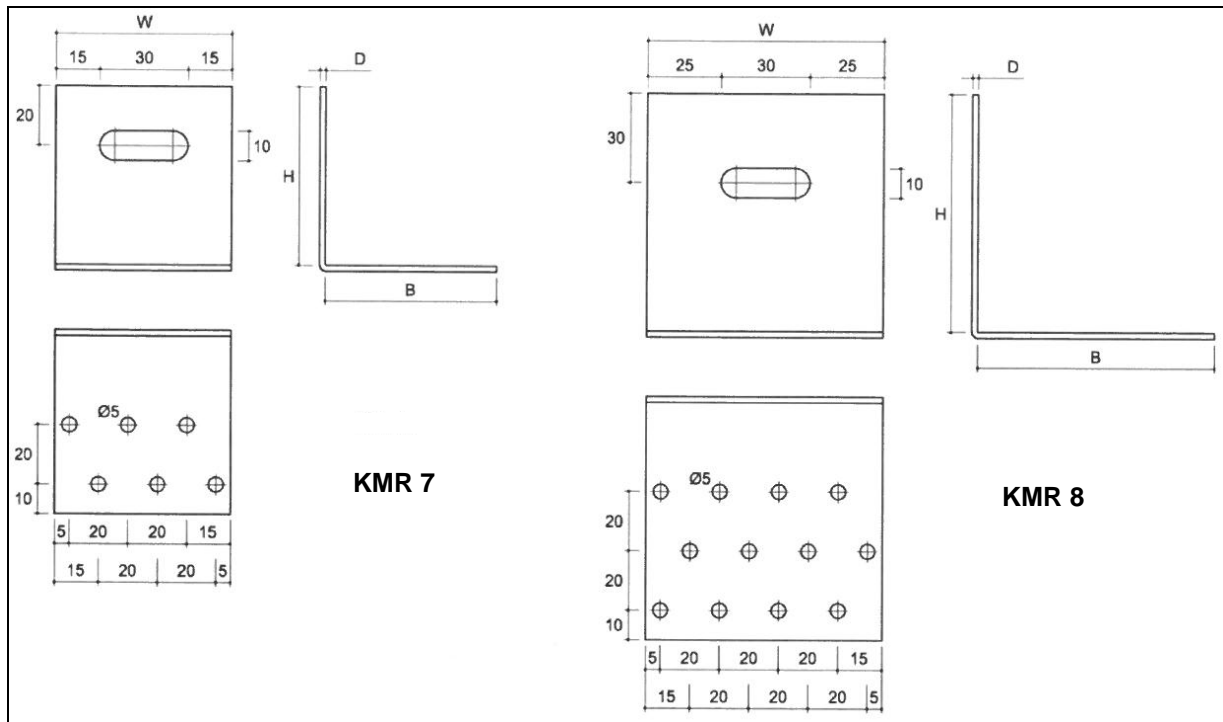
| Symbol | Dimensions [mm] |    |    |   | Quantity of openings |
|--------|-----------------|----|----|---|----------------------|
|        | W               | H  | B  | D | Ø 5                  |
| KMR 3  | 80              | 80 | 80 | 2 | 16                   |
| KMR 4  | 80              | 80 | 80 | 2 | 16                   |



**Figure 45** Type KMR

**Table 45** KMR three-dimensional nailing plate symbols and dimensions

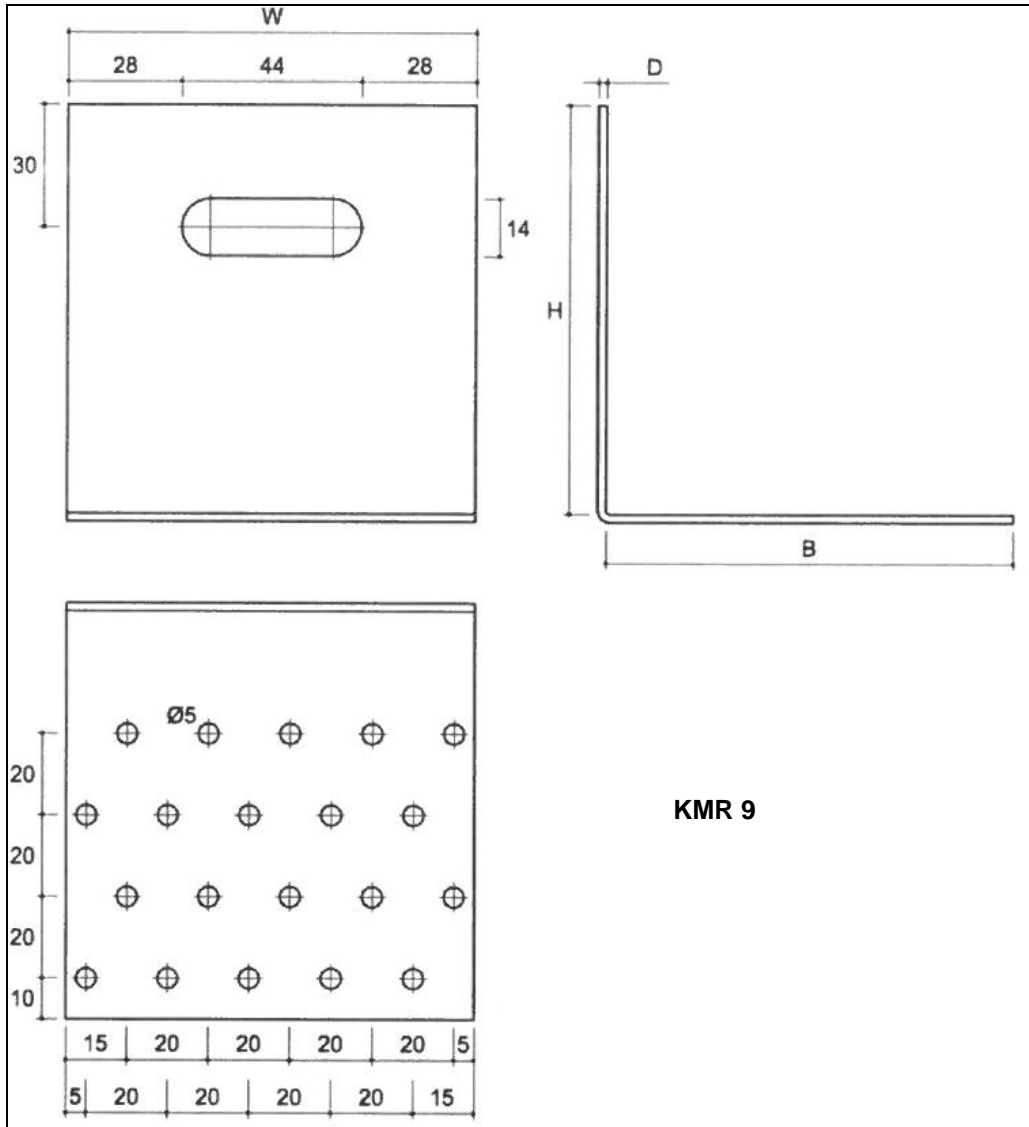
| Symbol | Dimensions [mm] |     |     |   | Quantity of openings |
|--------|-----------------|-----|-----|---|----------------------|
|        | W               | H   | B   | D | Ø 5                  |
| KMR 5  | 100             | 100 | 100 | 2 | 25                   |
| KMR 6  | 100             | 100 | 100 | 2 | 25                   |



**Figure 46** Type KMR

**Table 46** KMR three-dimensional nailing plate symbols and dimensions

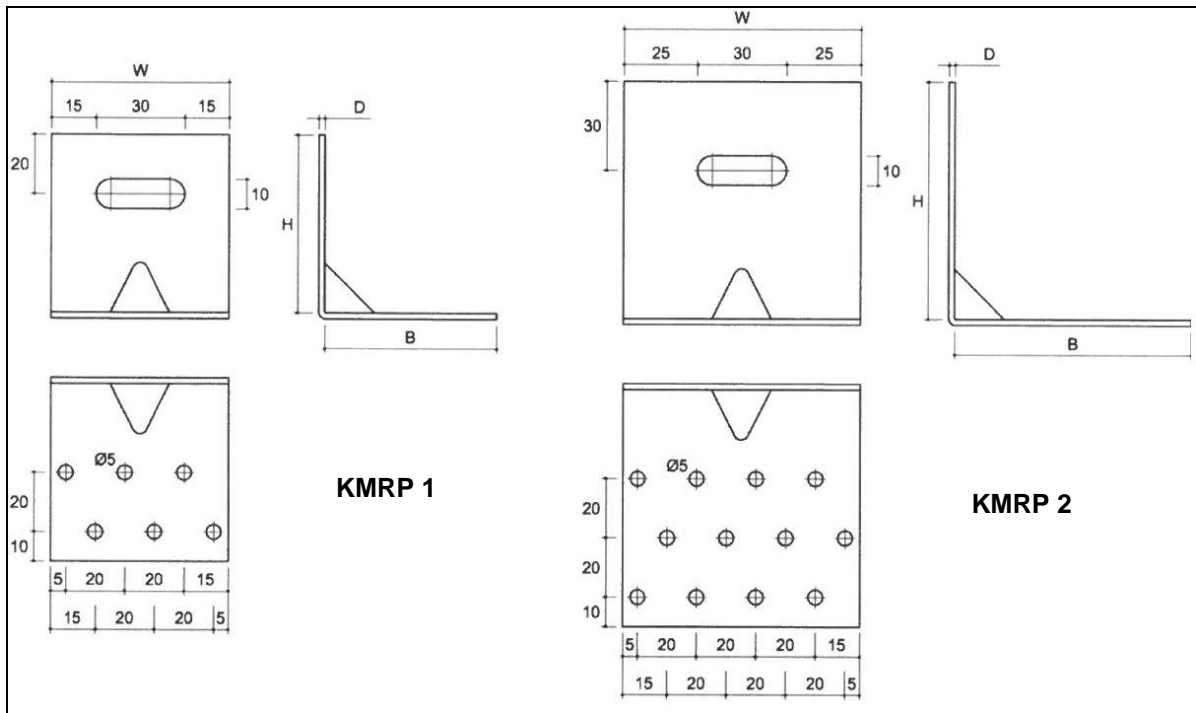
| Symbol | Dimensions [mm] |    |    |   | Quantity of openings |
|--------|-----------------|----|----|---|----------------------|
|        | W               | H  | B  | D | Ø 5                  |
| KMR 7  | 60              | 60 | 60 | 2 | 6                    |
| KMR 8  | 80              | 80 | 80 | 2 | 12                   |



**Figure 47** Type KMR

**Table 47** KMR three-dimensional nailing plate symbols and dimensions

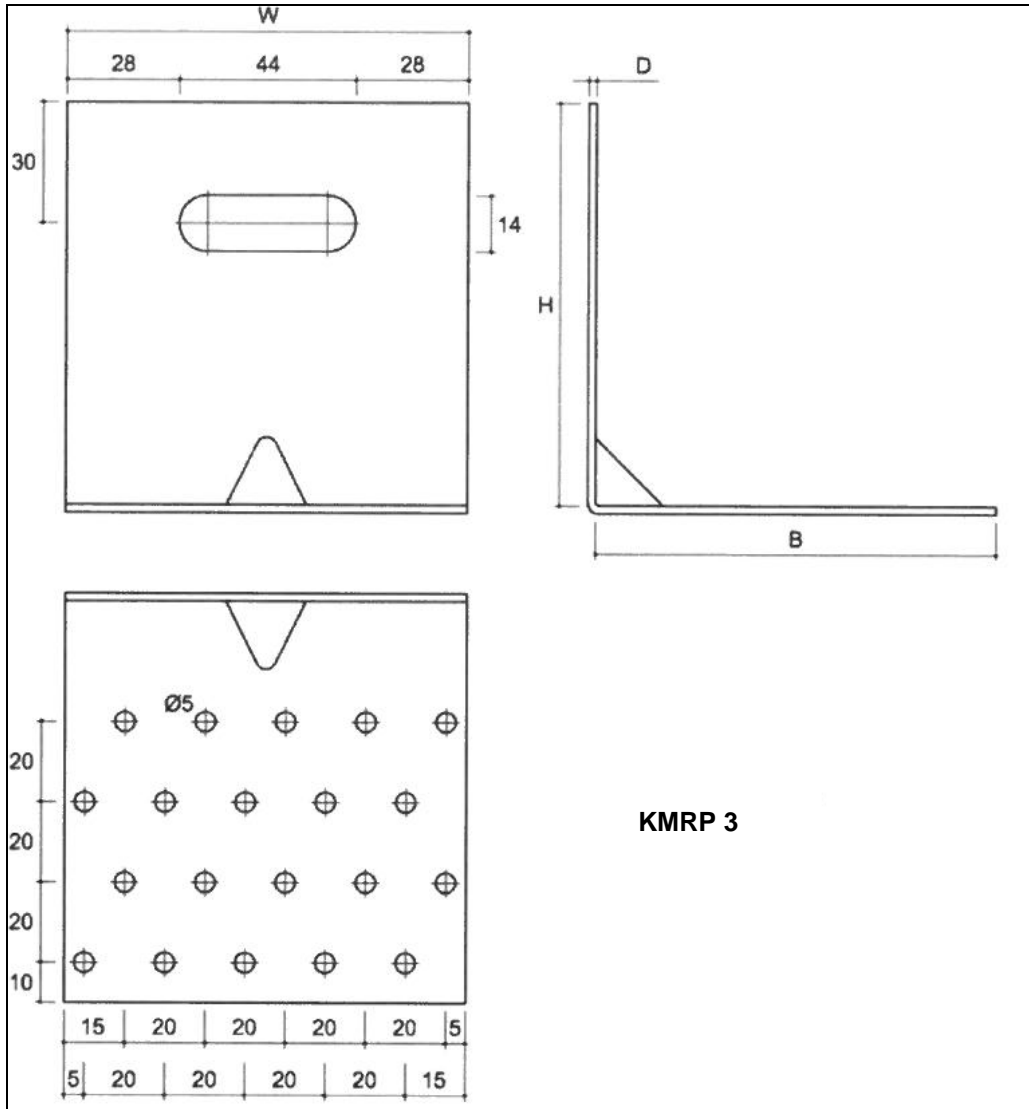
| Symbol | Dimensions [mm] |     |     |   | Quantity of openings |
|--------|-----------------|-----|-----|---|----------------------|
|        | W               | H   | B   | D | Ø 5                  |
| KMR 9  | 100             | 100 | 100 | 2 | 20                   |



**Figure 48** Type KMRP

**Table 48** KMRP three-dimensional nailing plate symbols and dimensions

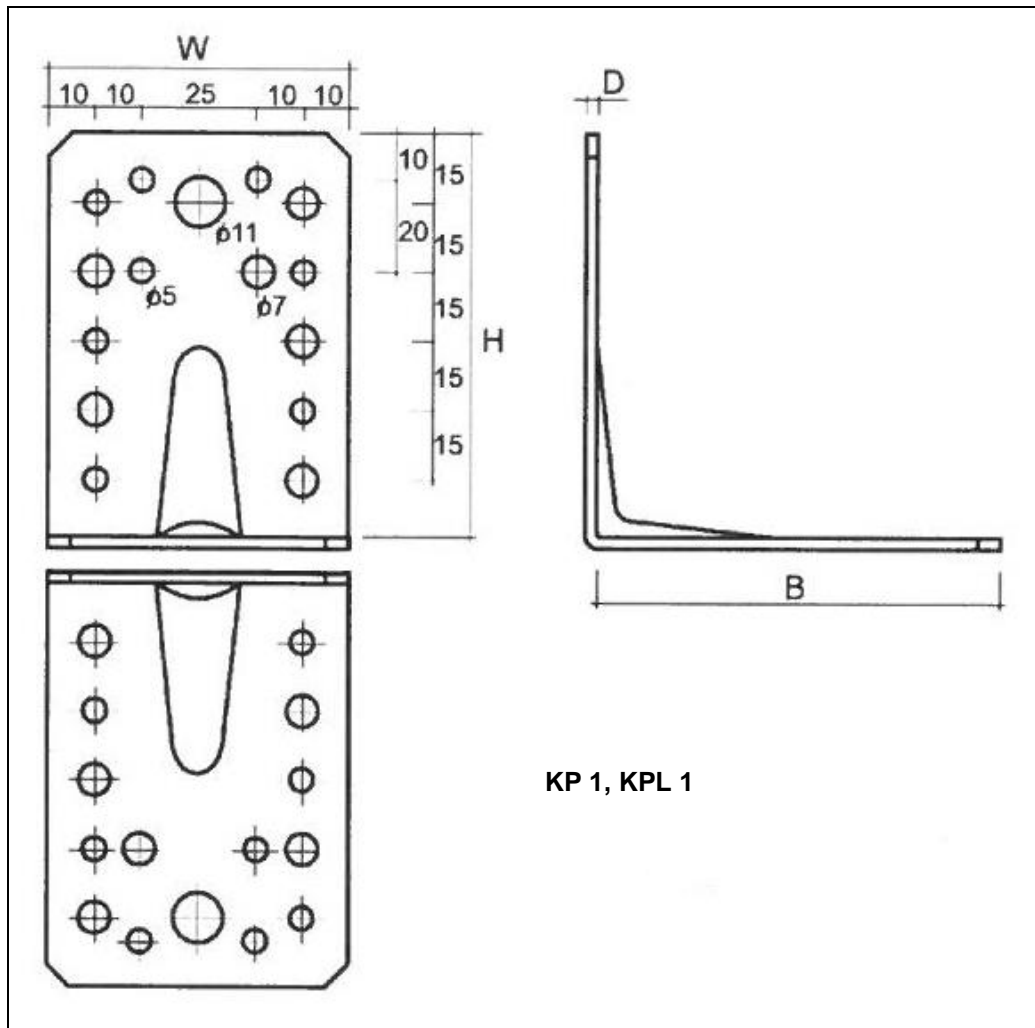
| Symbol | Dimensions [mm] |    |    |   | Quantity of openings |
|--------|-----------------|----|----|---|----------------------|
|        | W               | H  | B  | D | Ø 5                  |
| KMRP 1 | 60              | 60 | 60 | 2 | 6                    |
| KMRP 2 | 80              | 80 | 80 | 2 | 12                   |



**Figure 49** Type KMRP

**Table 49** KMRP three-dimensional nailing plate symbols and dimensions

| Symbol | Dimensions [mm] |     |     |   | Quantity of openings |
|--------|-----------------|-----|-----|---|----------------------|
|        | W               | H   | B   | D | $\varnothing 5$      |
| KMRP 3 | 100             | 100 | 100 | 2 | 20                   |

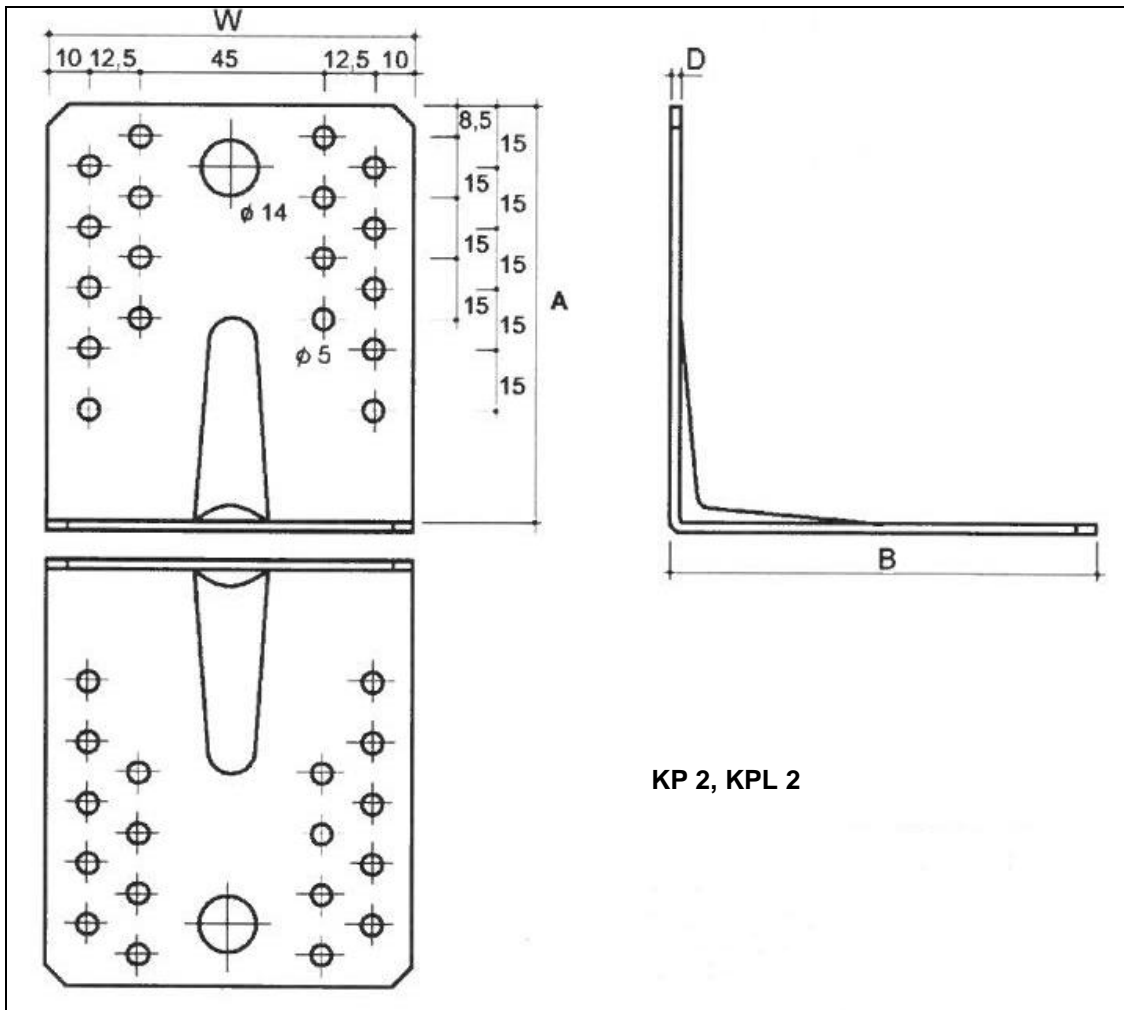


**Figure 50** Type KP, KPL

**Table 50** KP, KPL three-dimensional nailing plate symbols and dimensions

| Symbol | Dimensions [mm] |    |    |     | Quantity of openings |     |      |      |
|--------|-----------------|----|----|-----|----------------------|-----|------|------|
|        | W               | H  | B  | D   | Ø 5                  | Ø 7 | Ø 11 | Ø 14 |
| KP 1   | 65              | 90 | 90 | 2.5 | 16                   | 12  | 2    | -    |
| KPL 1  | 65              | 90 | 90 | 2.0 | 16                   | 12  | 2    | -    |

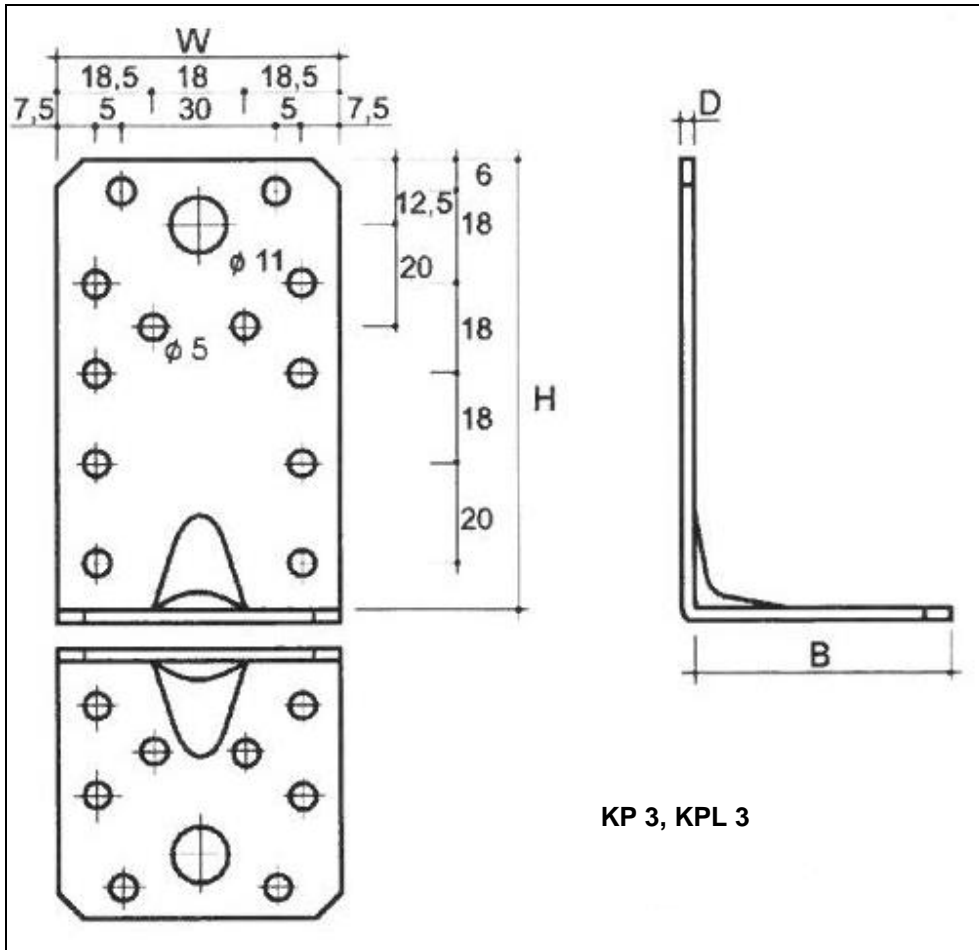




**Figure 51** Type KP, KPL

**Table 51** KP, KPL three-dimensional nailing plate symbols and dimensions

| Symbol | Dimensions [mm] |     |     |     | Quantity of openings |     |      |      |
|--------|-----------------|-----|-----|-----|----------------------|-----|------|------|
|        | W               | H   | B   | D   | Ø 5                  | Ø 7 | Ø 11 | Ø 14 |
| KP 2   | 90              | 105 | 105 | 2.5 | 36                   | -   | -    | 2    |
| KPL 2  | 90              | 105 | 105 | 2.0 | 36                   | -   | -    | 2    |

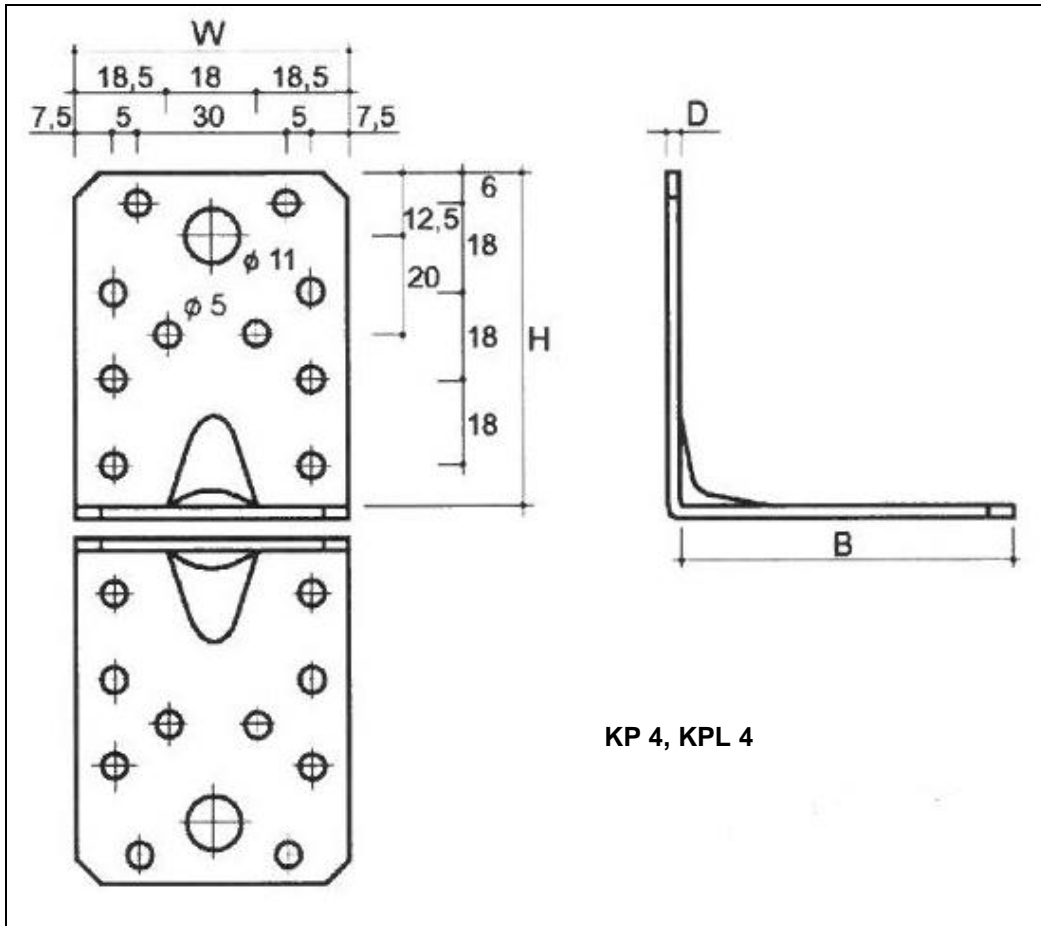


KP 3, KPL 3

Figure 52 Type KP, KPL

Table 52 KP, KPL three-dimensional nailing plate symbols and dimensions

| Symbol | Dimensions [mm] |    |    |     | Quantity of openings |     |      |      |
|--------|-----------------|----|----|-----|----------------------|-----|------|------|
|        | W               | H  | B  | D   | Ø 5                  | Ø 7 | Ø 11 | Ø 14 |
| KP 3   | 55              | 90 | 50 | 2.5 | 20                   | -   | 2    | -    |
| KPL 3  | 55              | 90 | 50 | 2.0 | 20                   | -   | 2    | -    |

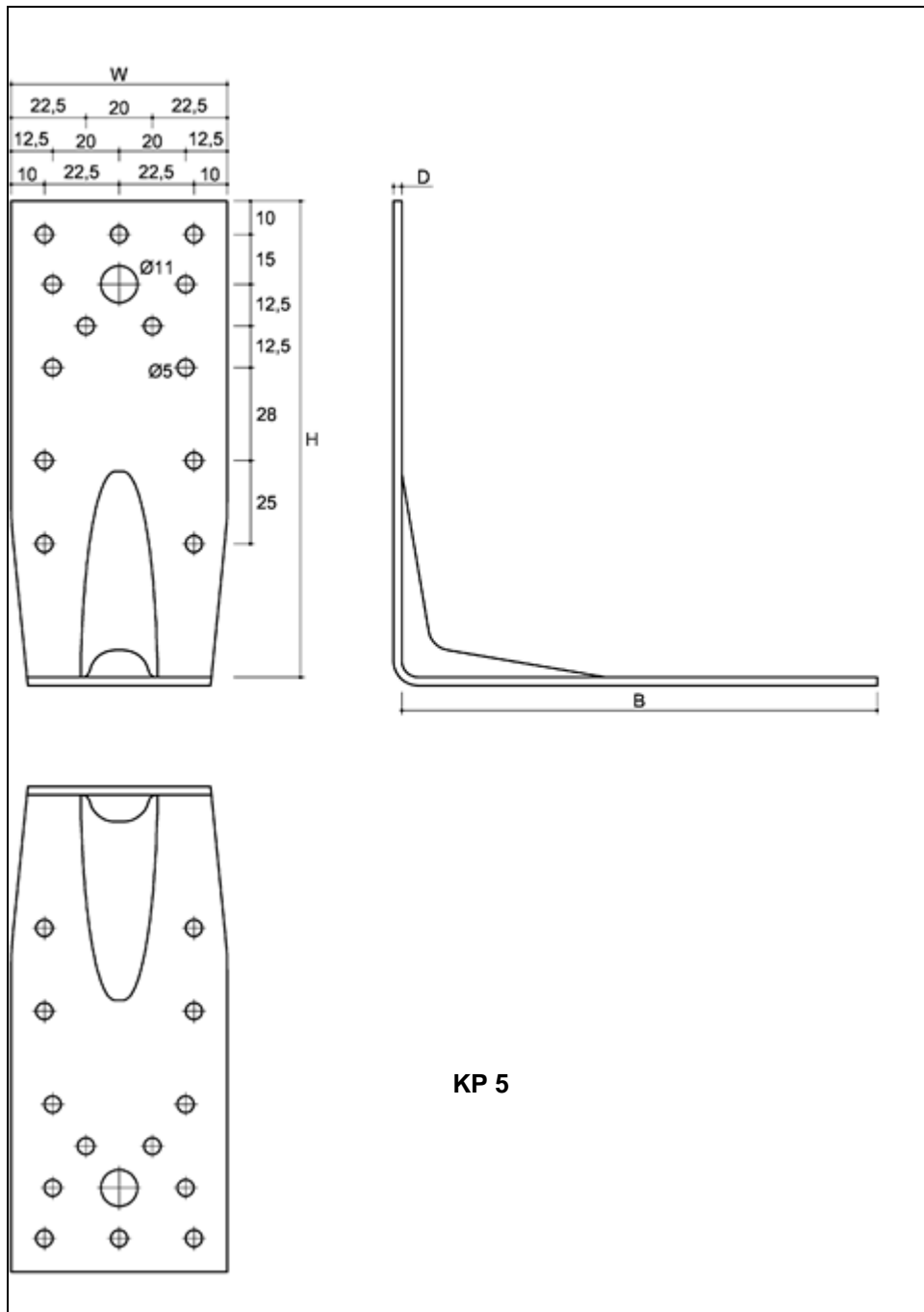


KP 4, KPL 4

Figure 53 Type KP, KPL

Table 53 KP, KPL three-dimensional nailing plate symbols and dimensions

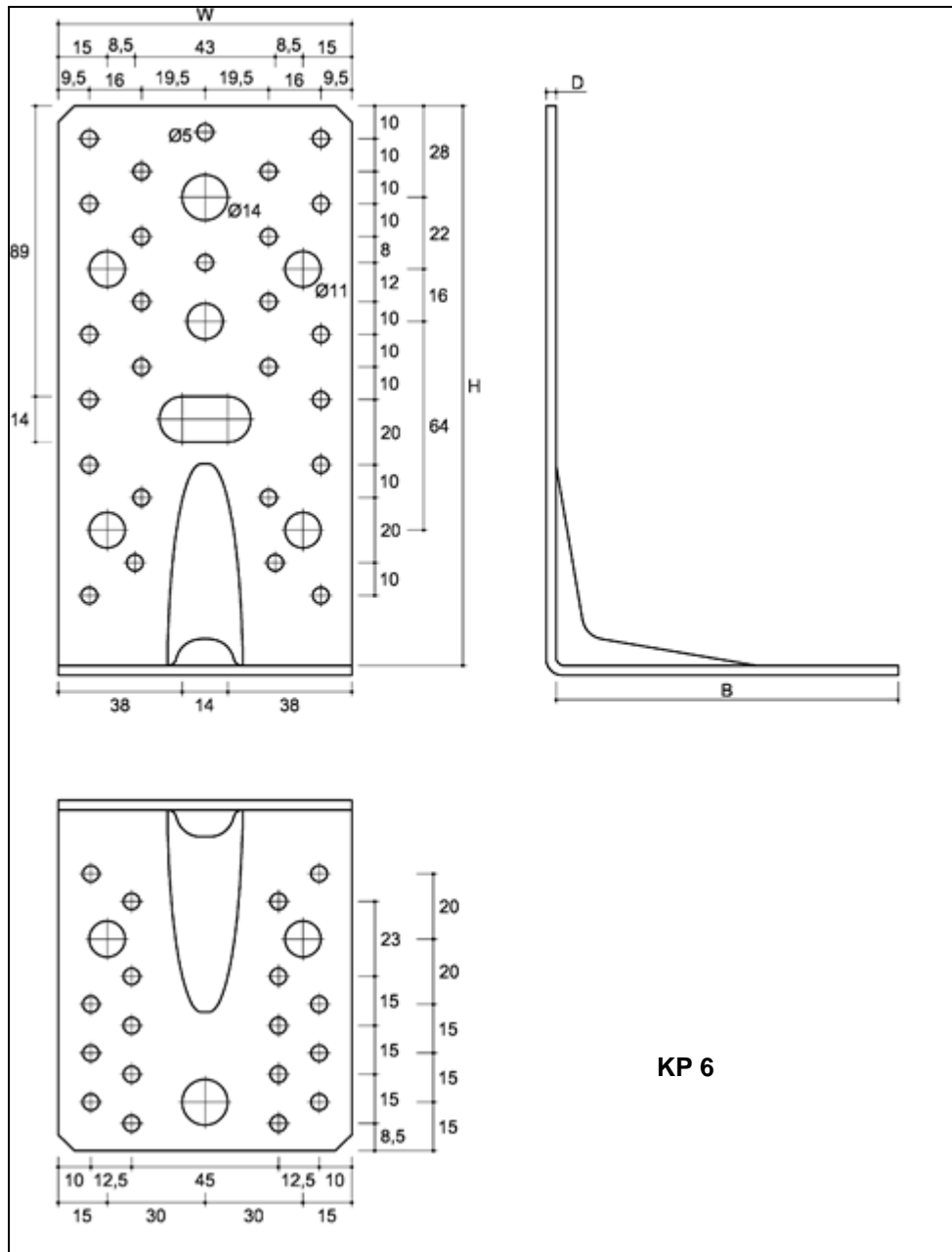
| Symbol | Dimensions [mm] |    |    |     | Quantity of openings |     |      |      |
|--------|-----------------|----|----|-----|----------------------|-----|------|------|
|        | W               | H  | B  | D   | Ø 5                  | Ø 7 | Ø 11 | Ø 14 |
| KP 4   | 55              | 70 | 70 | 2.5 | 20                   | -   | 2    | -    |
| KPL 4  | 55              | 70 | 70 | 2.0 | 20                   | -   | 2    | -    |



**Figure 54** Type KP

**Table 54** KP three-dimensional nailing plate symbols and dimensions

| Symbol | Dimensions [mm] |     |     |     | Quantity of openings |     |      |      |
|--------|-----------------|-----|-----|-----|----------------------|-----|------|------|
|        | W               | H   | B   | D   | Ø 5                  | Ø 7 | Ø 11 | Ø 14 |
| KP 5   | 65              | 140 | 140 | 2.5 | 26                   | 2   | -    | -    |

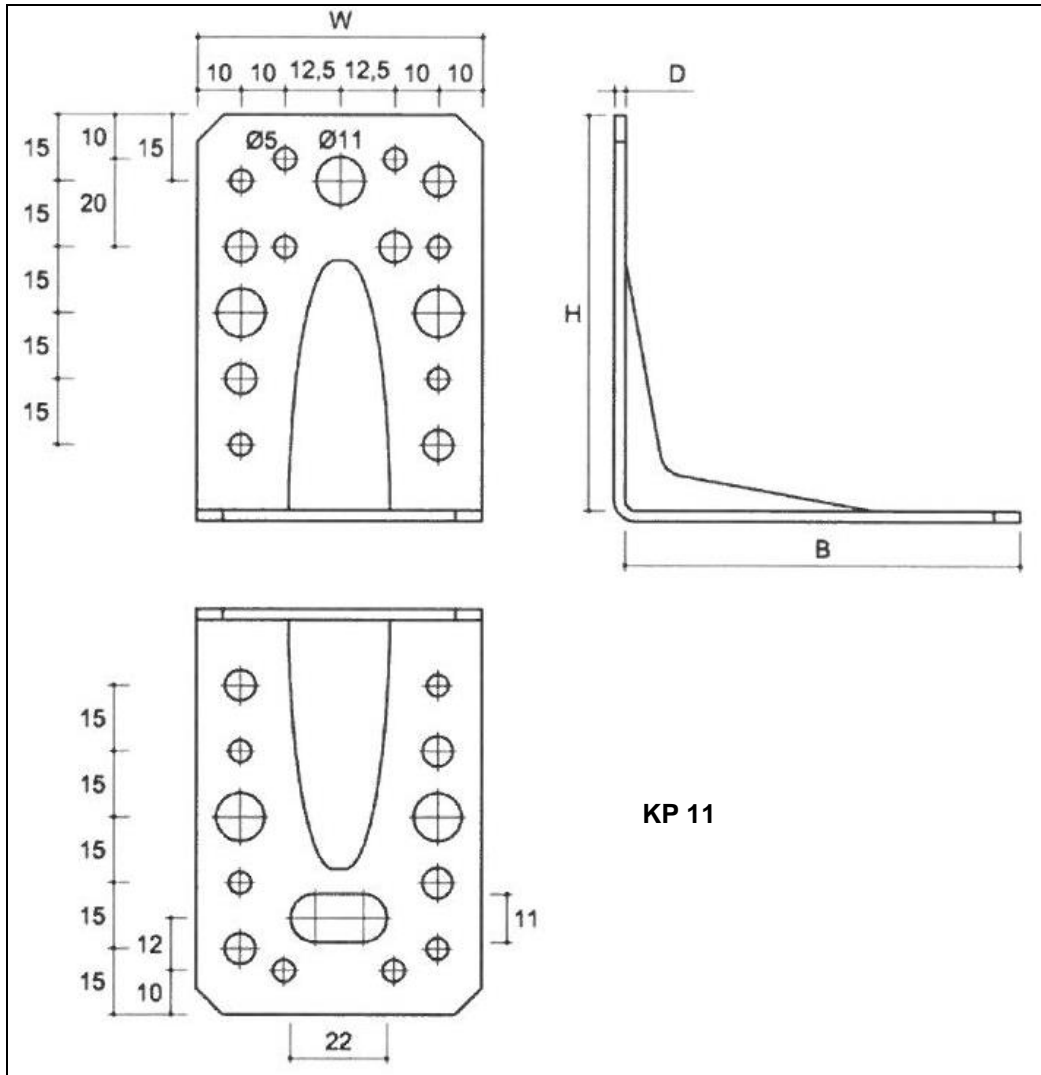


**Figure 55** Type KP

**Table 55** KP three-dimensional nailing plate symbols and dimensions

| Symbol | Dimensions [mm] |     |     |   | Quantity of openings |     |      |      |
|--------|-----------------|-----|-----|---|----------------------|-----|------|------|
|        | W               | H   | B   | D | Ø 5                  | Ø 7 | Ø 11 | Ø 14 |
| KP 6   | 90              | 172 | 105 | 3 | 44                   | 7   | -    | 2    |

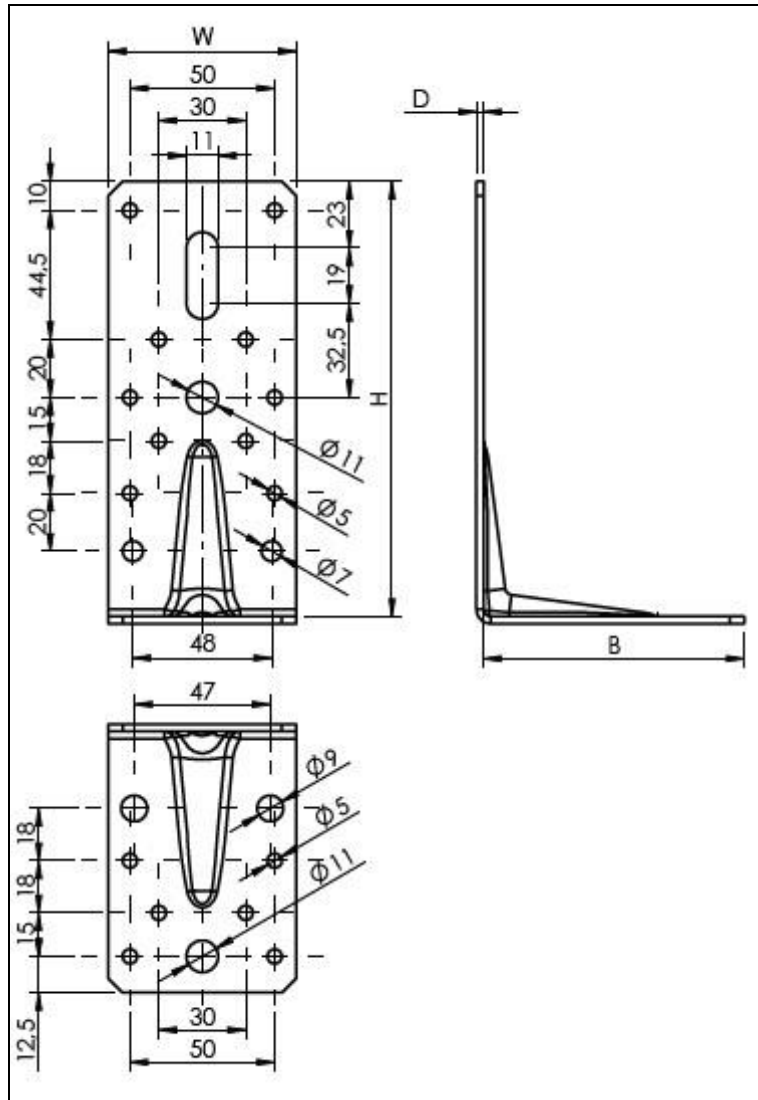




**Figure 57** Type KP

**Table 57** KP three-dimensional nailing plate symbols and dimensions

| Symbol | Dimensions [mm] |    |    |     | Quantity of openings |                 |                  |                  |
|--------|-----------------|----|----|-----|----------------------|-----------------|------------------|------------------|
|        | W               | H  | B  | D   | $\varnothing 5$      | $\varnothing 7$ | $\varnothing 11$ | $\varnothing 14$ |
| KP 11  | 65              | 90 | 90 | 2.5 | 13                   | 9               | 5                | -                |

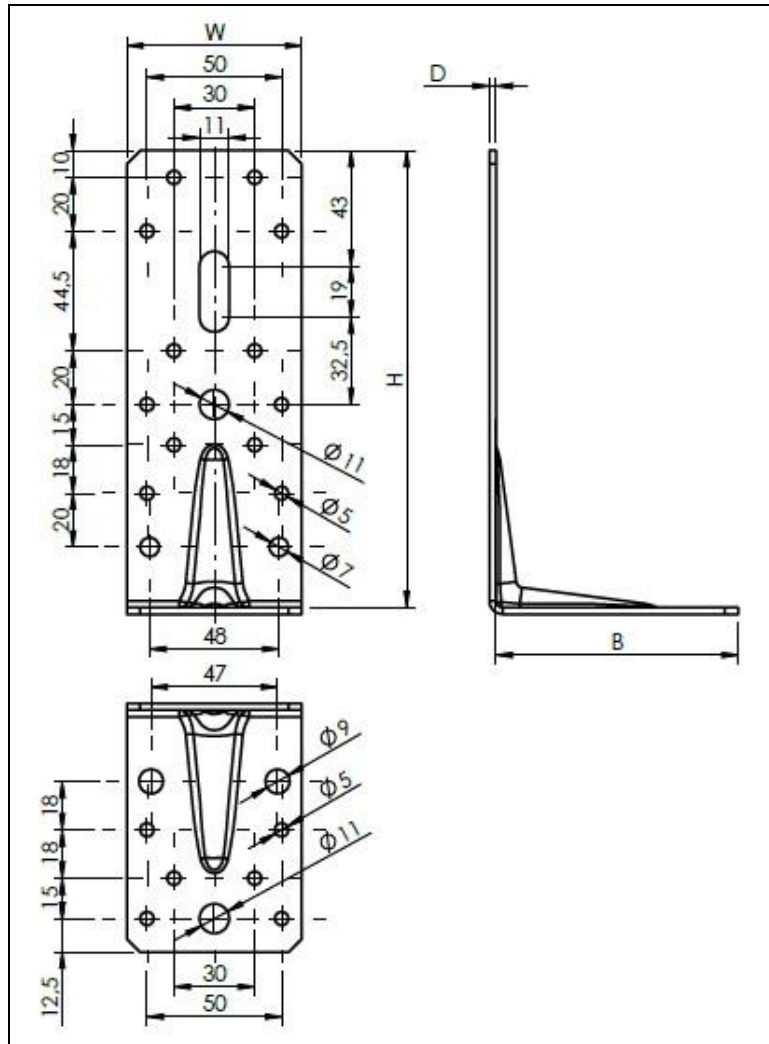


**Figure 58** Type KP 12, KPL 12

**Table 58** KP, KPL three-dimensional nailing plate symbols and dimensions

| Symbol | Dimensions [mm] |     |    |     | Quantity of openings |    |    |     |
|--------|-----------------|-----|----|-----|----------------------|----|----|-----|
|        | W               | H   | B  | D   | Ø5                   | Ø7 | Ø9 | Ø11 |
| KP 12  | 65              | 150 | 90 | 2.5 | 16                   | 2  | 2  | 2   |
| KPL 12 | 65              | 150 | 90 | 2.0 | 16                   | 2  | 2  | 2   |

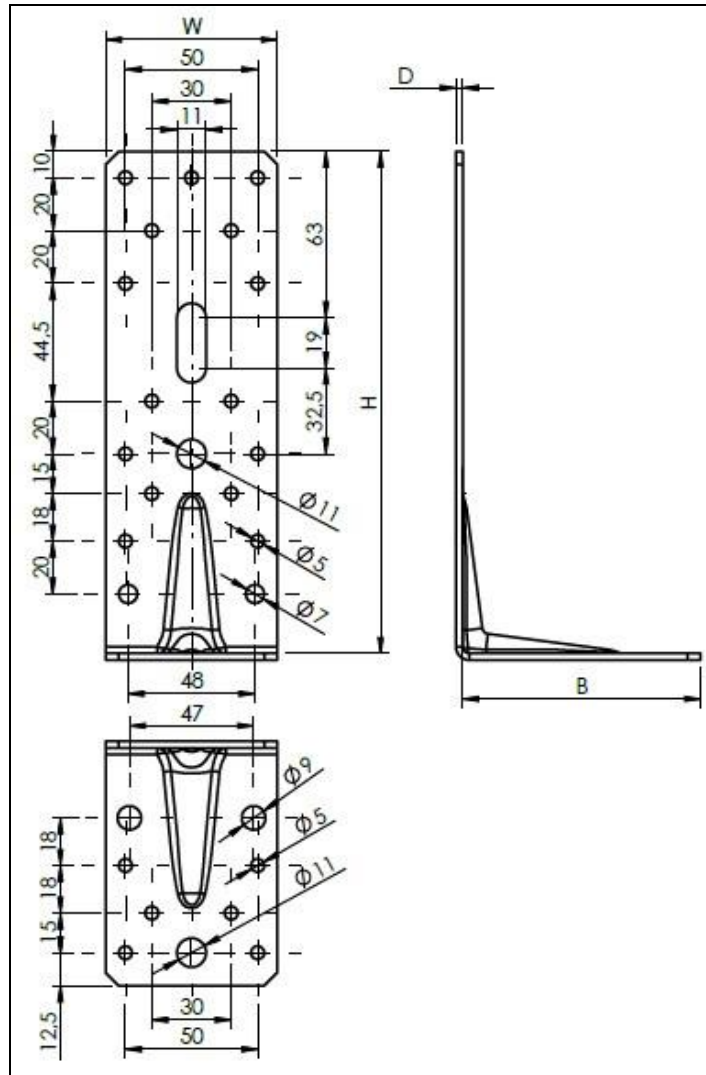




**Figure 59** Type KP 13

**Table 59** KP three-dimensional nailing plate symbols and dimensions

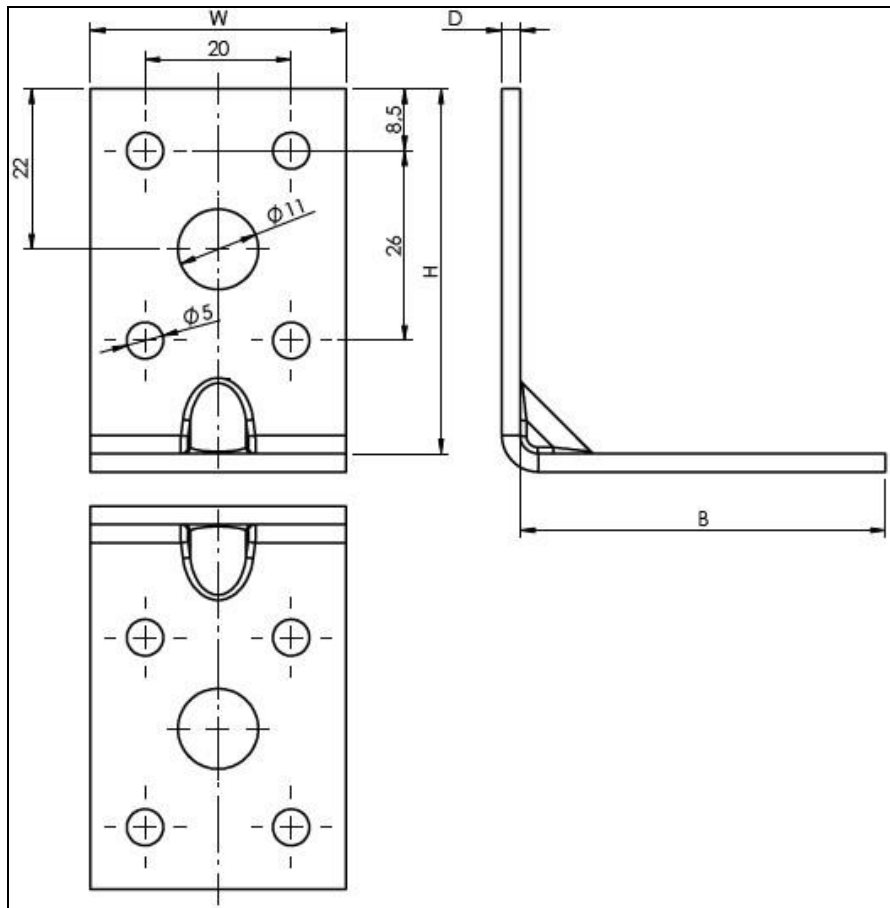
| Symbol | Dimensions [mm] |     |    |     | Quantity of openings |    |    |     |
|--------|-----------------|-----|----|-----|----------------------|----|----|-----|
|        | W               | H   | B  | D   | Ø5                   | Ø7 | Ø9 | Ø11 |
| KP 13  | 65              | 170 | 90 | 2.5 | 18                   | 2  | 2  | 2   |



**Figure 60** Type KP 14

**Table 60** KP three-dimensional nailing plate symbols and dimensions

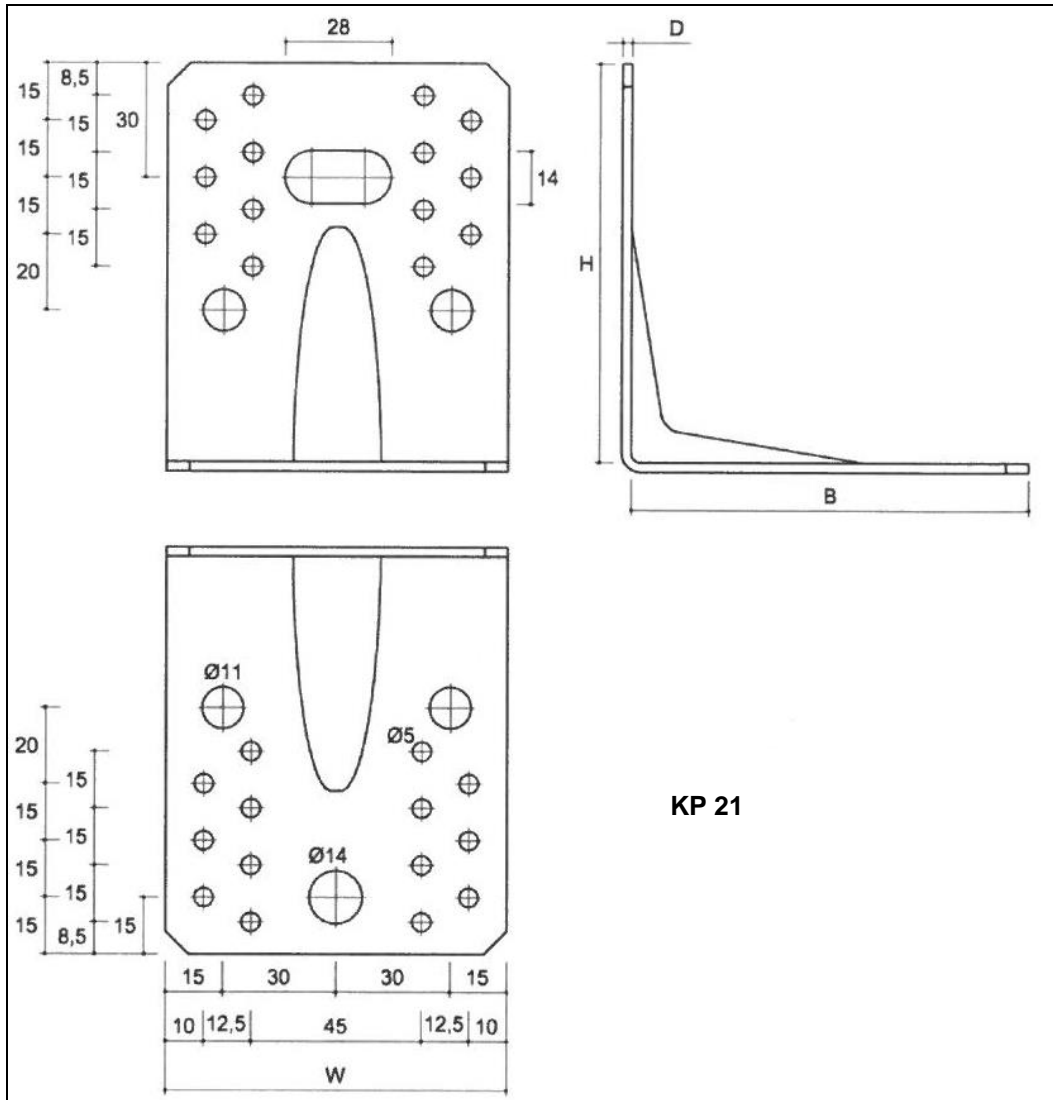
| Symbol | Dimensions [mm] |     |    |     | Quantity of openings |    |    |     |
|--------|-----------------|-----|----|-----|----------------------|----|----|-----|
|        | W               | H   | B  | D   | Ø5                   | Ø7 | Ø9 | Ø11 |
| KP 14  | 65              | 190 | 90 | 2.5 | 21                   | 2  | 2  | 2   |



**Figure 61** Type KP 15

**Table 61** KP three-dimensional nailing plate symbols and dimensions

| Symbol | Dimensions [mm] |    |    |     | Quantity of openings |     |
|--------|-----------------|----|----|-----|----------------------|-----|
|        | W               | H  | B  | D   | Ø5                   | Ø11 |
| KP 15  | 35              | 50 | 50 | 2.5 | 8                    | 2   |

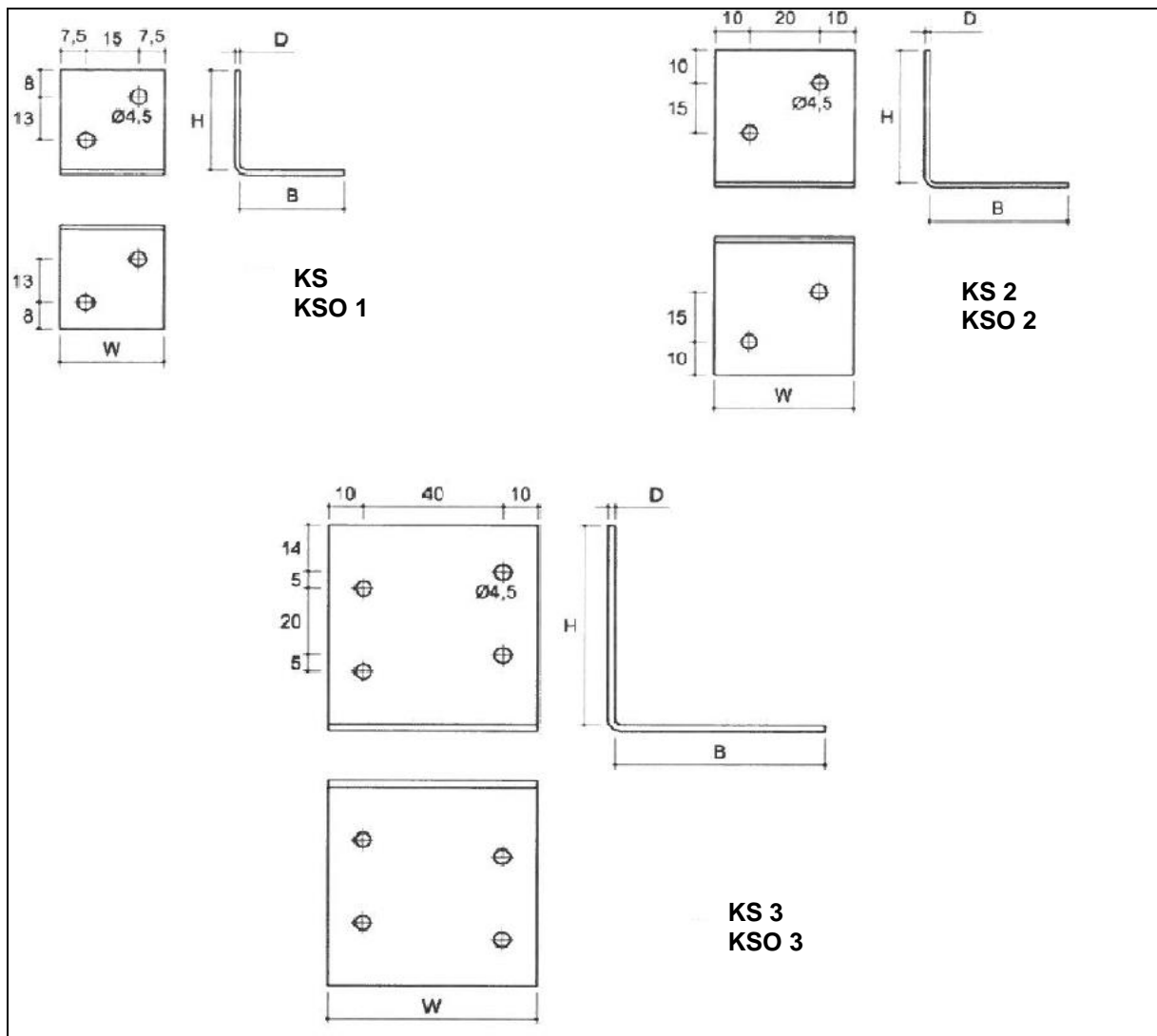


KP 21

Figure 62 Type KP

Table 62 KP three-dimensional nailing plate symbols and dimensions

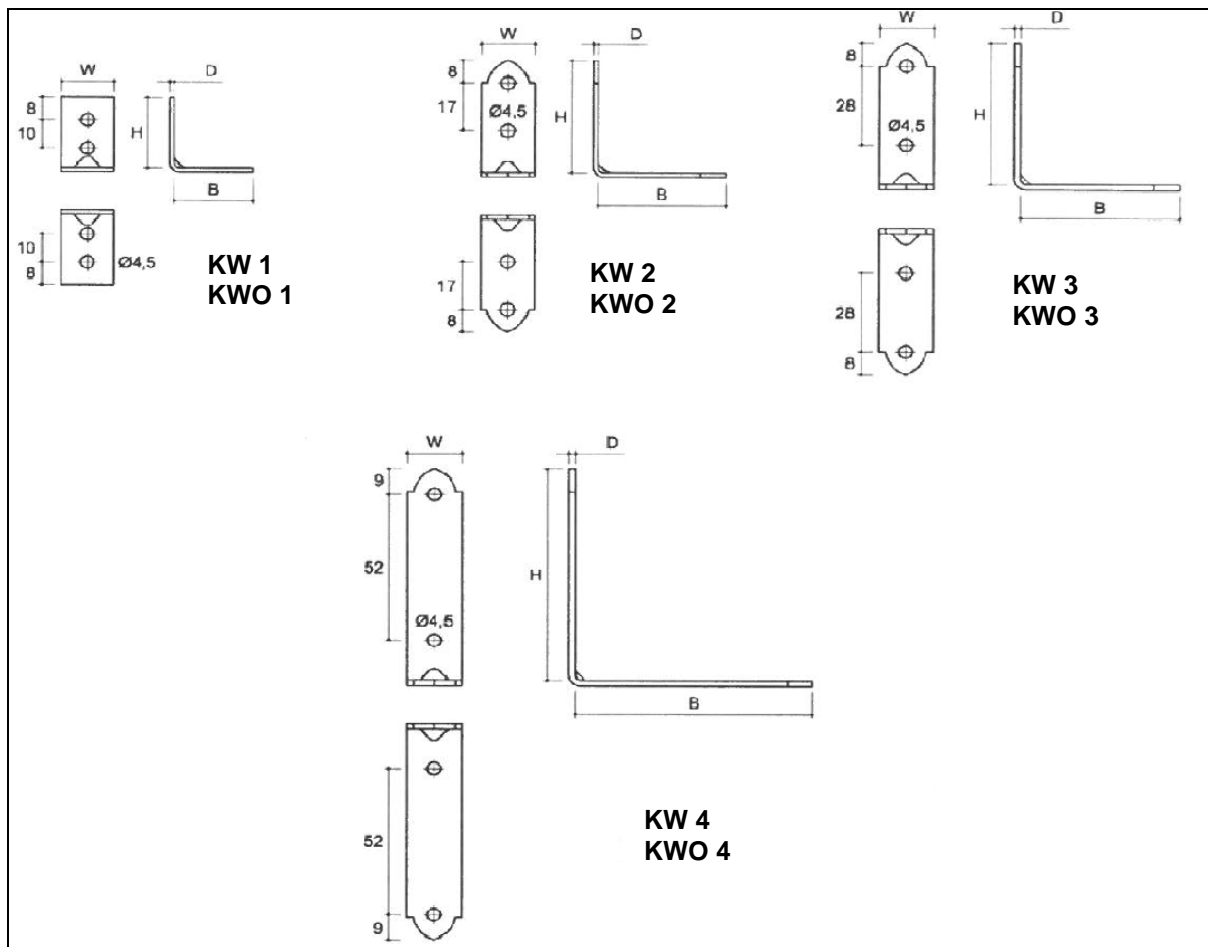
| Symbol | Dimensions [mm] |     |     |     | Quantity of openings |                 |                  |                  |
|--------|-----------------|-----|-----|-----|----------------------|-----------------|------------------|------------------|
|        | W               | H   | B   | D   | $\varnothing 5$      | $\varnothing 7$ | $\varnothing 11$ | $\varnothing 14$ |
| KP 21  | 90              | 105 | 105 | 2,5 | 28                   | -               | 4                | 1                |



**Figure 63** Type KS, KSO

**Table 63** KS, KSO three-dimensional nailing plate symbols and dimensions

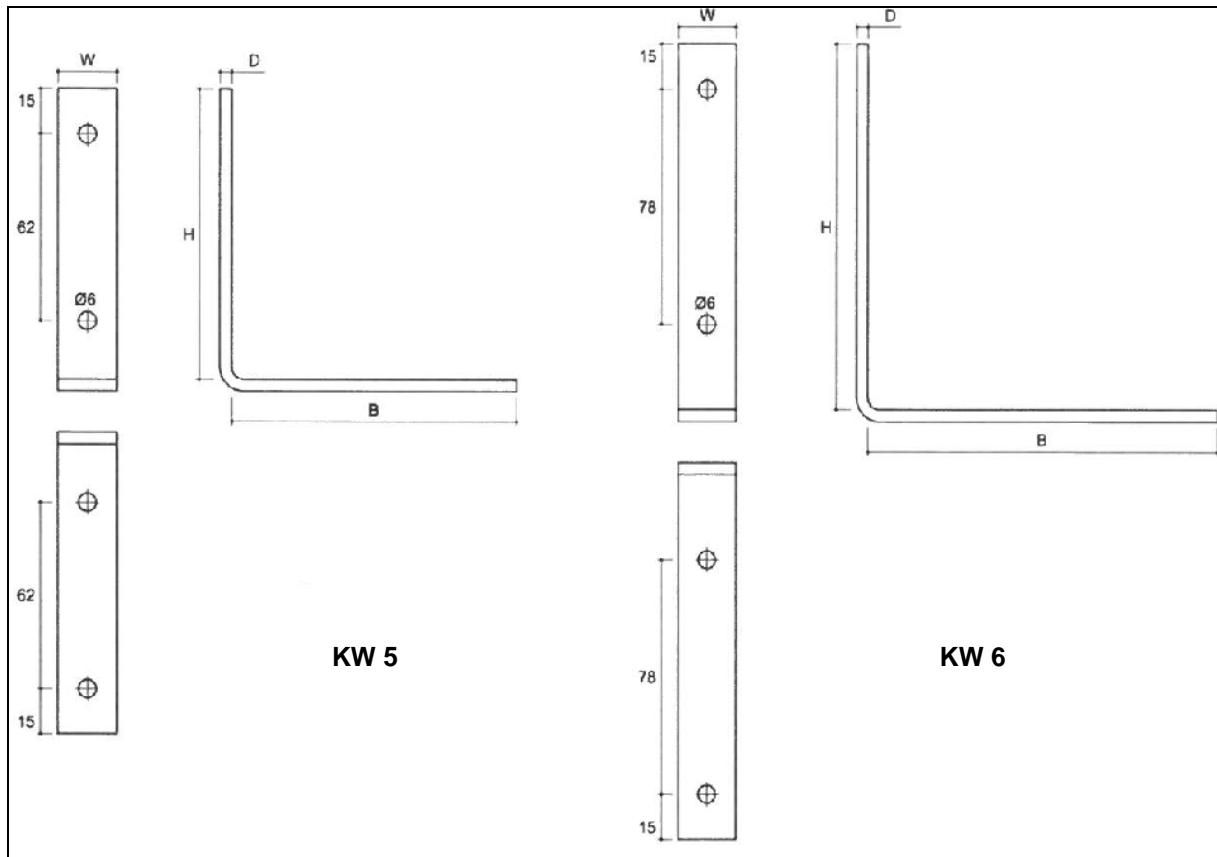
| Symbol        | Dimensions [mm] |    |    |     | Quantity of openings |
|---------------|-----------------|----|----|-----|----------------------|
|               | W               | H  | B  | D   | Ø 4.5                |
| KS 1<br>KSO 1 | 30              | 30 | 30 | 1.5 | 4                    |
| KS 2<br>KSO 2 | 40              | 40 | 40 | 1.5 | 4                    |
| KS 3<br>KSO 3 | 60              | 60 | 60 | 2   | 8                    |



**Figure 64** Type KW, KWO

**Table 64** KW, KWO three-dimensional nailing plate symbols and dimensions

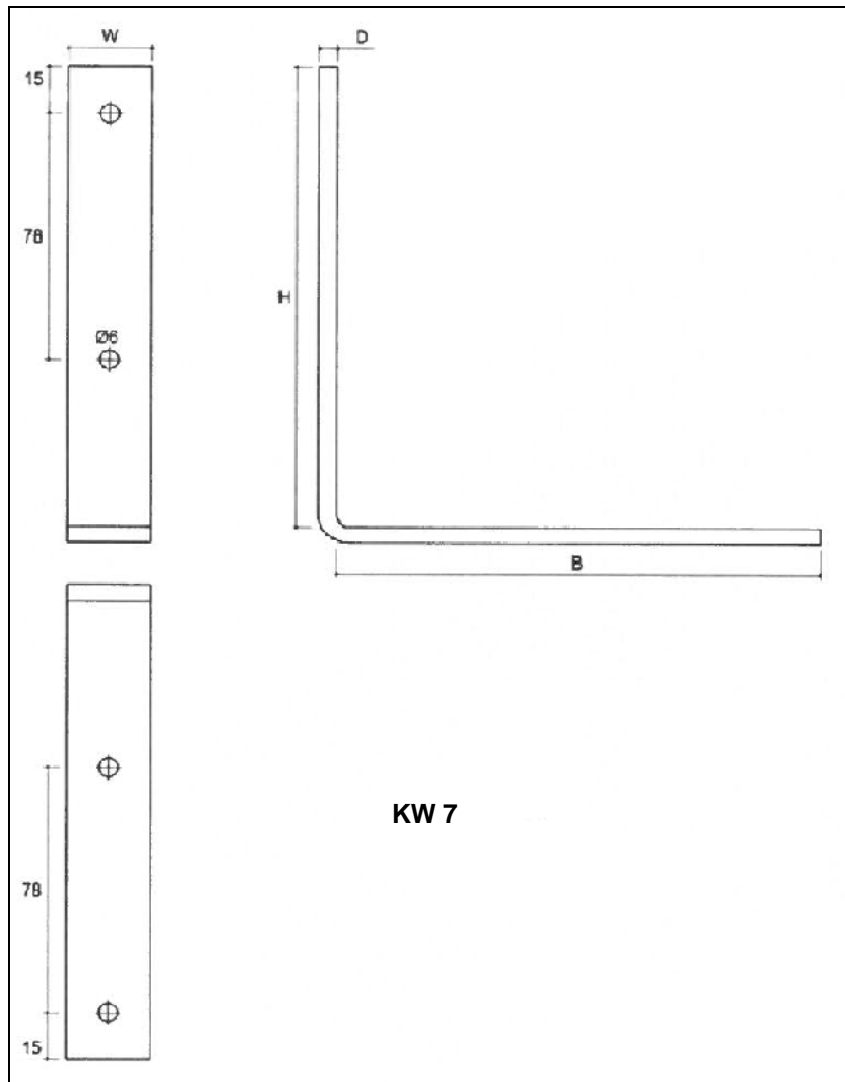
| Symbol        | Dimensions [mm] |    |    |     | Quantity of openings |
|---------------|-----------------|----|----|-----|----------------------|
|               | W               | H  | B  | D   | Ø 4.5                |
| KW 1<br>KWO 1 | 17              | 25 | 25 | 1.5 | 4                    |
| KW 2<br>KWO 2 | 17              | 40 | 40 | 1.5 | 4                    |
| KW 3<br>KWO 3 | 17              | 50 | 50 | 2   | 4                    |
| KW 4<br>KWO 4 | 17              | 75 | 75 | 2   | 4                    |



**Figure 65** Type KW

**Table 65** KW three-dimensional nailing plate symbols and dimensions

| Symbol | Dimensions [mm] |     |     |   | Quantity of openings<br>Ø 6 |
|--------|-----------------|-----|-----|---|-----------------------------|
|        | W               | H   | B   | D |                             |
| KW 5   | 20              | 96  | 96  | 4 | 4                           |
| KW 6   | 20              | 121 | 121 | 4 | 4                           |

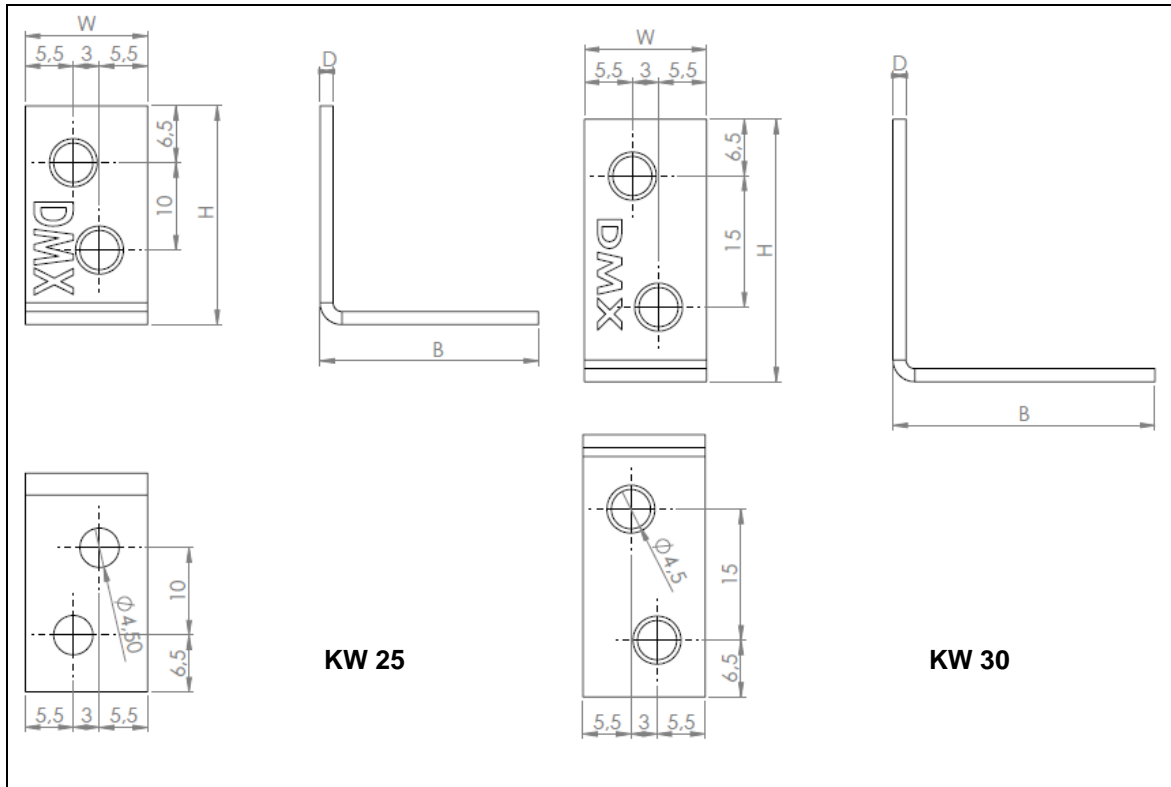


**Figure 66** Type KW

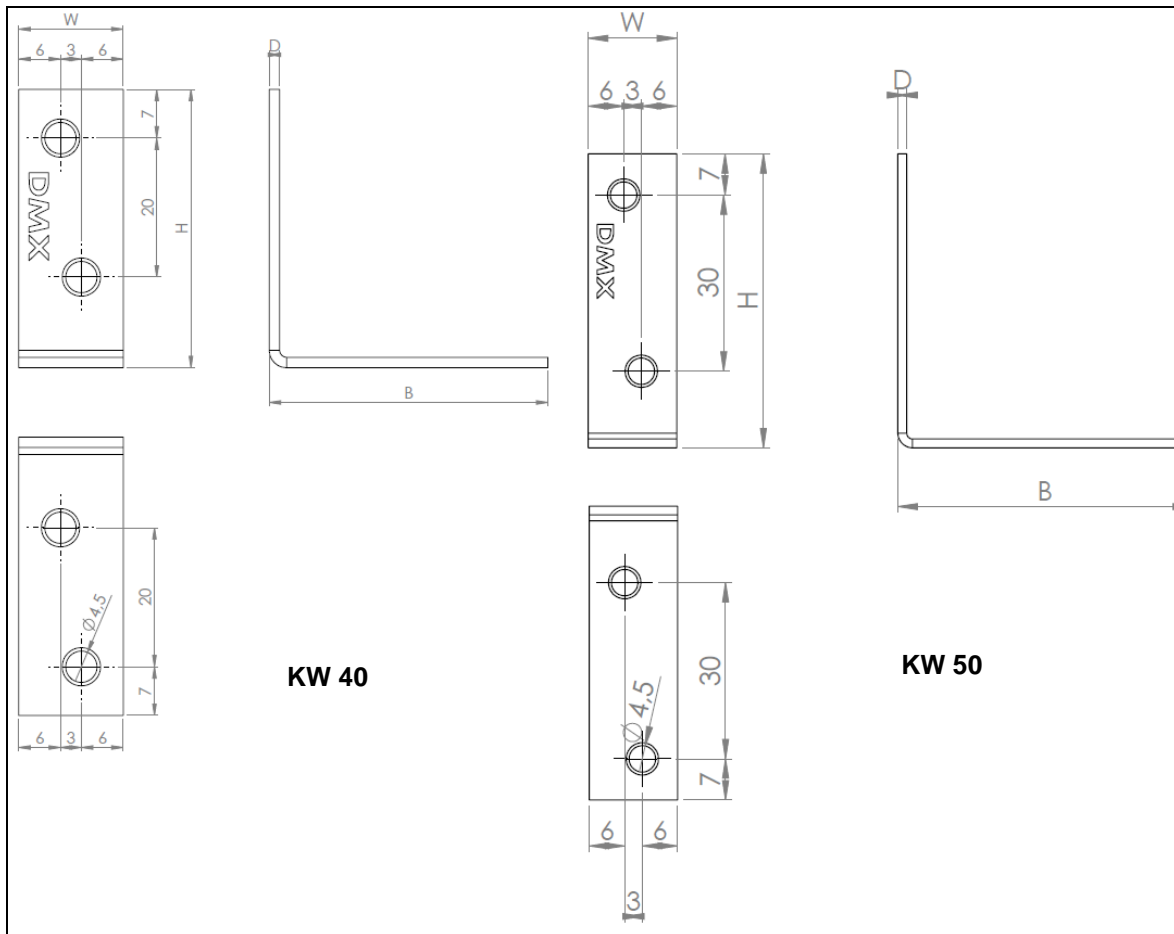
**Table 66** KW three-dimensional nailing plate symbols and dimensions

| Symbol | Dimensions [mm] |     |     |   | Quantity of openings |
|--------|-----------------|-----|-----|---|----------------------|
|        | W               | H   | B   | D | Ø 6                  |
| KW 7   | 25              | 146 | 146 | 5 | 4                    |

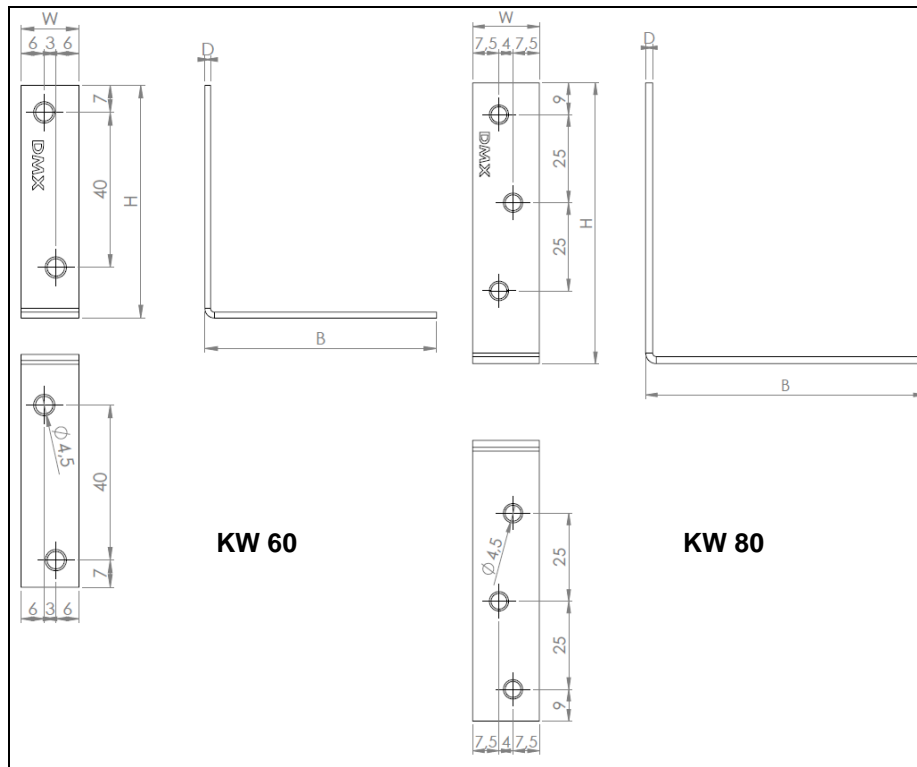




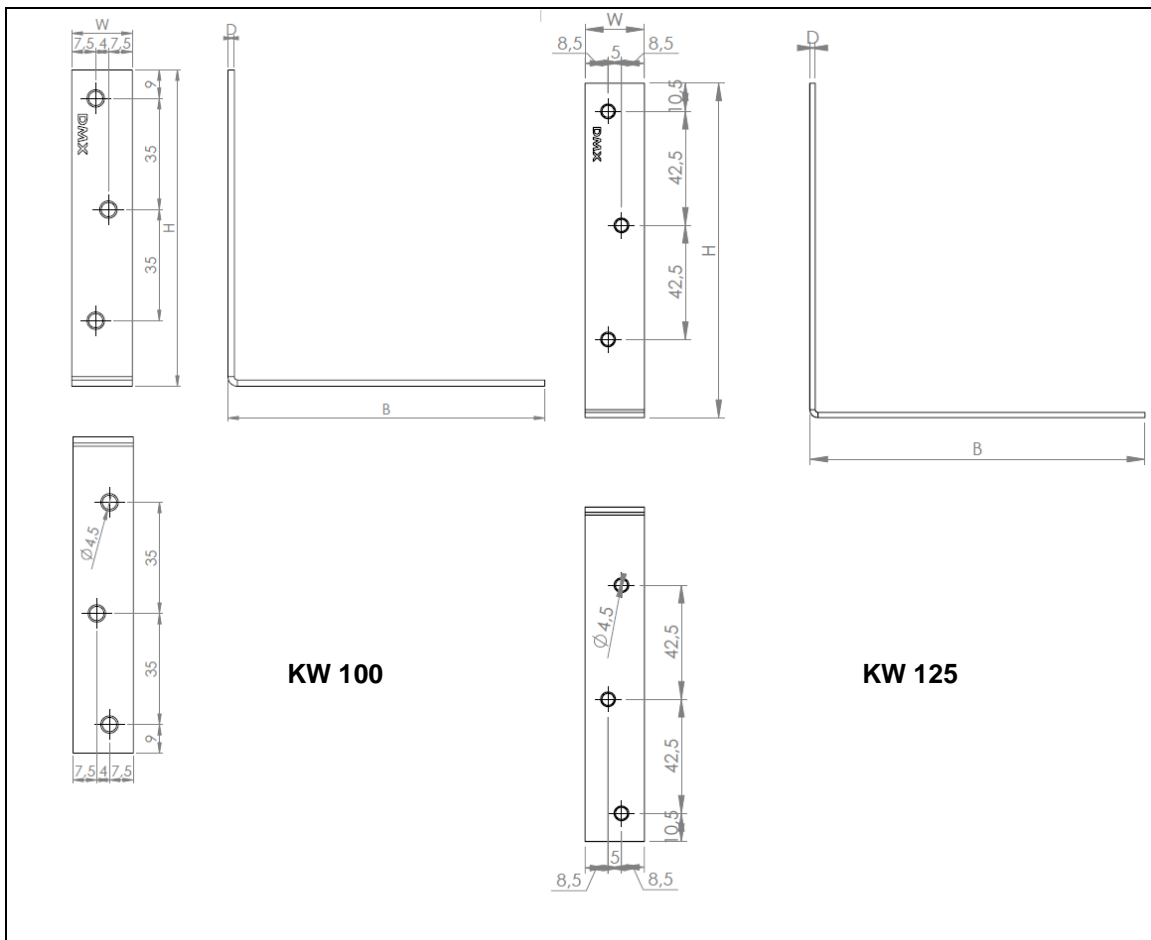
**Figure 67 Type KW**



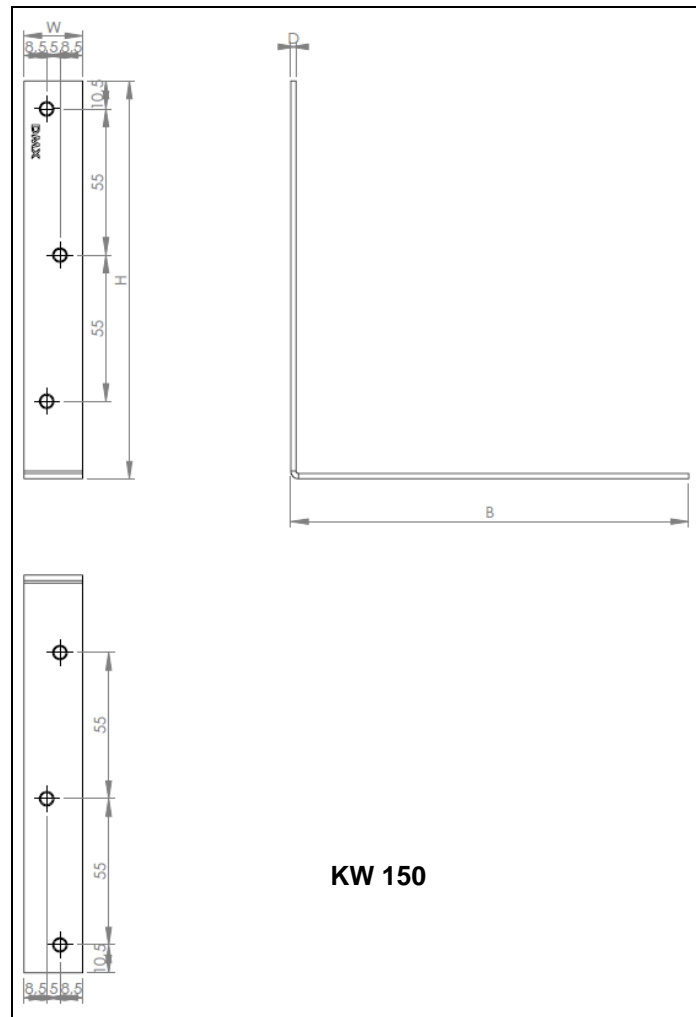
**Figure 68 Type KW**



**Figure 69 Type KW**



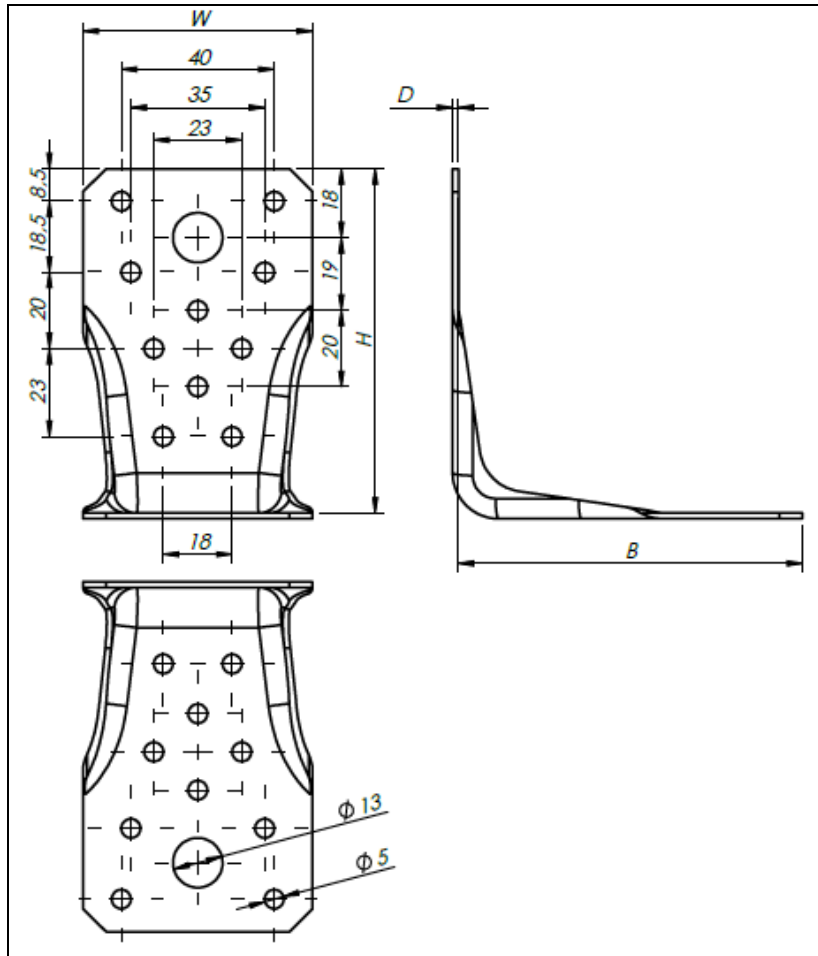
**Figure 70 Type KW**



**Figure 71** Type KW

**Table 67** KW three-dimensional nailing plate symbols and dimensions

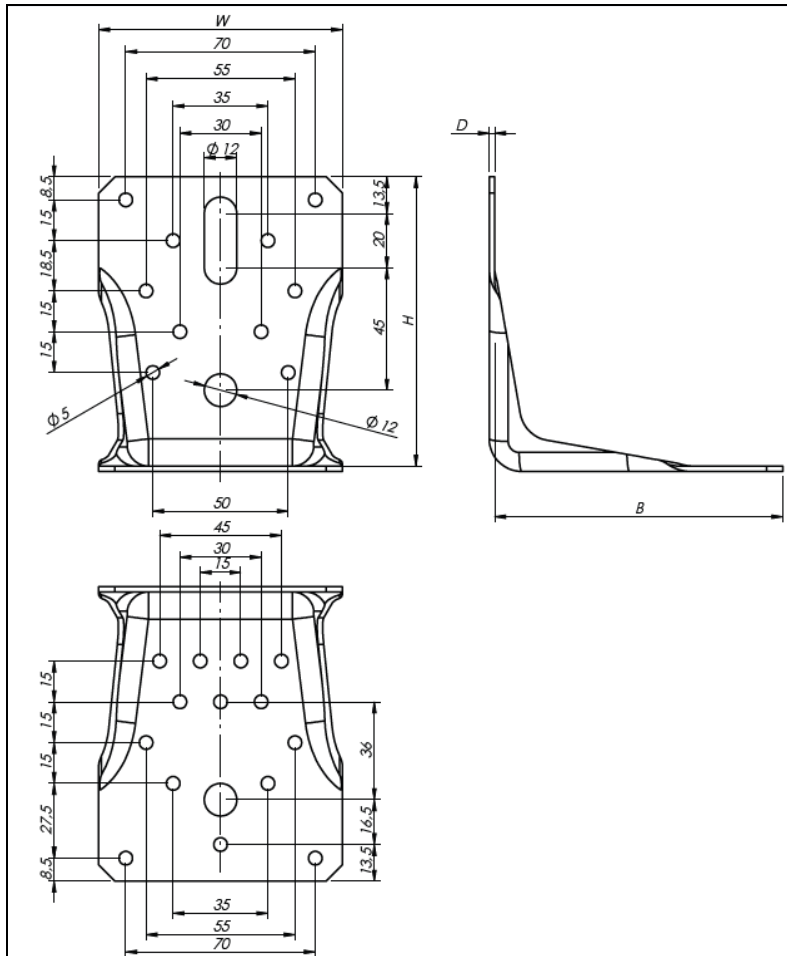
| Symbol | Dimensions [mm] |     |     |     | Quantity of openings |
|--------|-----------------|-----|-----|-----|----------------------|
|        | W               | H   | B   | D   | Ø 4.5                |
| KW 25  | 14              | 25  | 25  | 1.5 | 4                    |
| KW 30  | 14              | 30  | 30  | 1.5 | 4                    |
| KW 40  | 15              | 40  | 40  | 1.5 | 4                    |
| KW 50  | 15              | 50  | 50  | 1.5 | 4                    |
| KW 60  | 15              | 60  | 60  | 1.5 | 4                    |
| KW 80  | 19              | 80  | 80  | 2   | 6                    |
| KW 100 | 19              | 100 | 100 | 2   | 6                    |
| KW 125 | 22              | 125 | 125 | 2   | 6                    |
| KW 150 | 22              | 150 | 150 | 2   | 6                    |



**Figure 72** Type LBS

**Table 68** LBS three-dimensional nailing plate symbols and dimensions

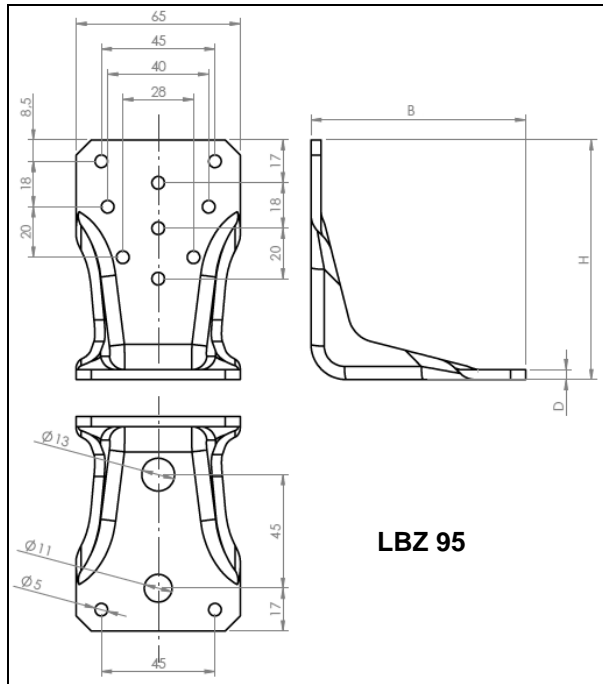
| Symbol | Dimensions [mm] |    |    |     | Quantity of openings |     |
|--------|-----------------|----|----|-----|----------------------|-----|
|        | W               | H  | B  | D   | Ø5                   | Ø13 |
| LBS 90 | 60              | 90 | 90 | 1.5 | 20                   | 2   |



**Figure 73** Type LBS

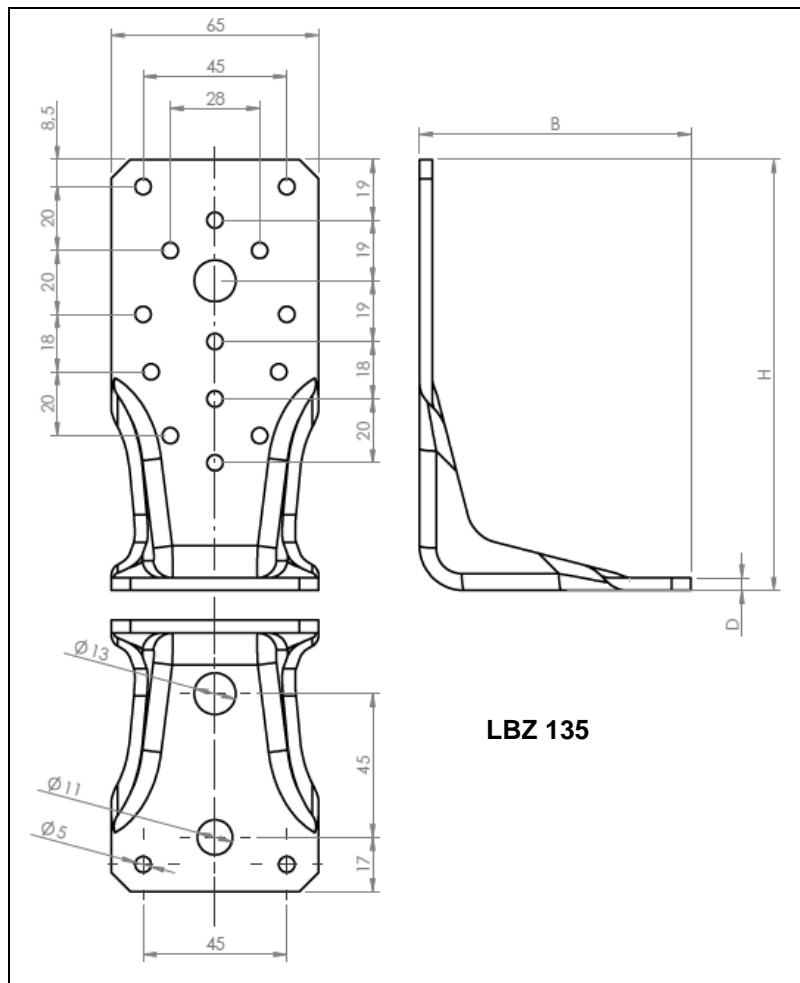
**Table 69** LBS three-dimensional nailing plate symbols and dimensions

| Symbol  | Dimensions [mm] |     |     |     | Quantity of openings |     |
|---------|-----------------|-----|-----|-----|----------------------|-----|
|         | W               | H   | B   | D   | Ø5                   | Ø12 |
| LBS 105 | 90              | 105 | 105 | 2.0 | 24                   | 2   |



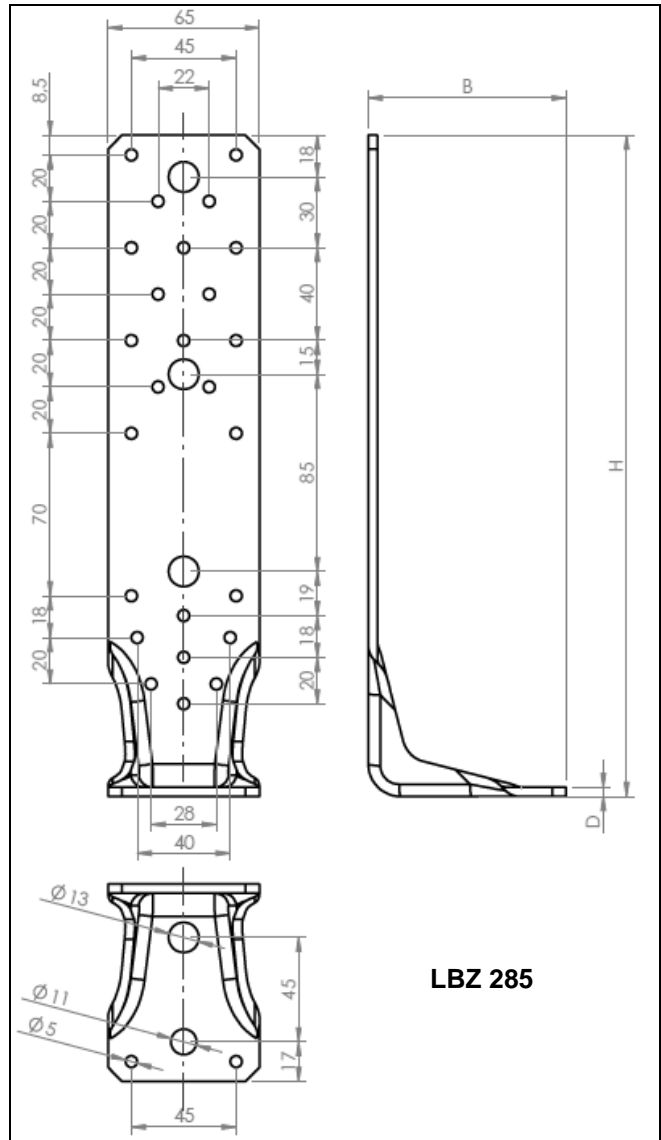
**LBZ 95**

**Figure 74 Type LBZ**



**LBZ 135**

**Figure 75 Type LBZ**



**Figure 76** Type LBZ

**Table 70** LBZ three-dimensional nailing plate symbols and dimensions

| Symbol  | Dimensions [mm] |     |    |   | Quantity of openings |      |      |
|---------|-----------------|-----|----|---|----------------------|------|------|
|         | W               | H   | B  | D | Ø 5                  | Ø 11 | Ø 13 |
| LBZ 95  | 65              | 95  | 85 | 4 | 11                   | 1    | 1    |
| LBZ 135 | 65              | 135 | 85 | 4 | 16                   | 1    | 2    |
| LBZ 285 | 65              | 285 | 85 | 4 | 27                   | 1    | 4    |

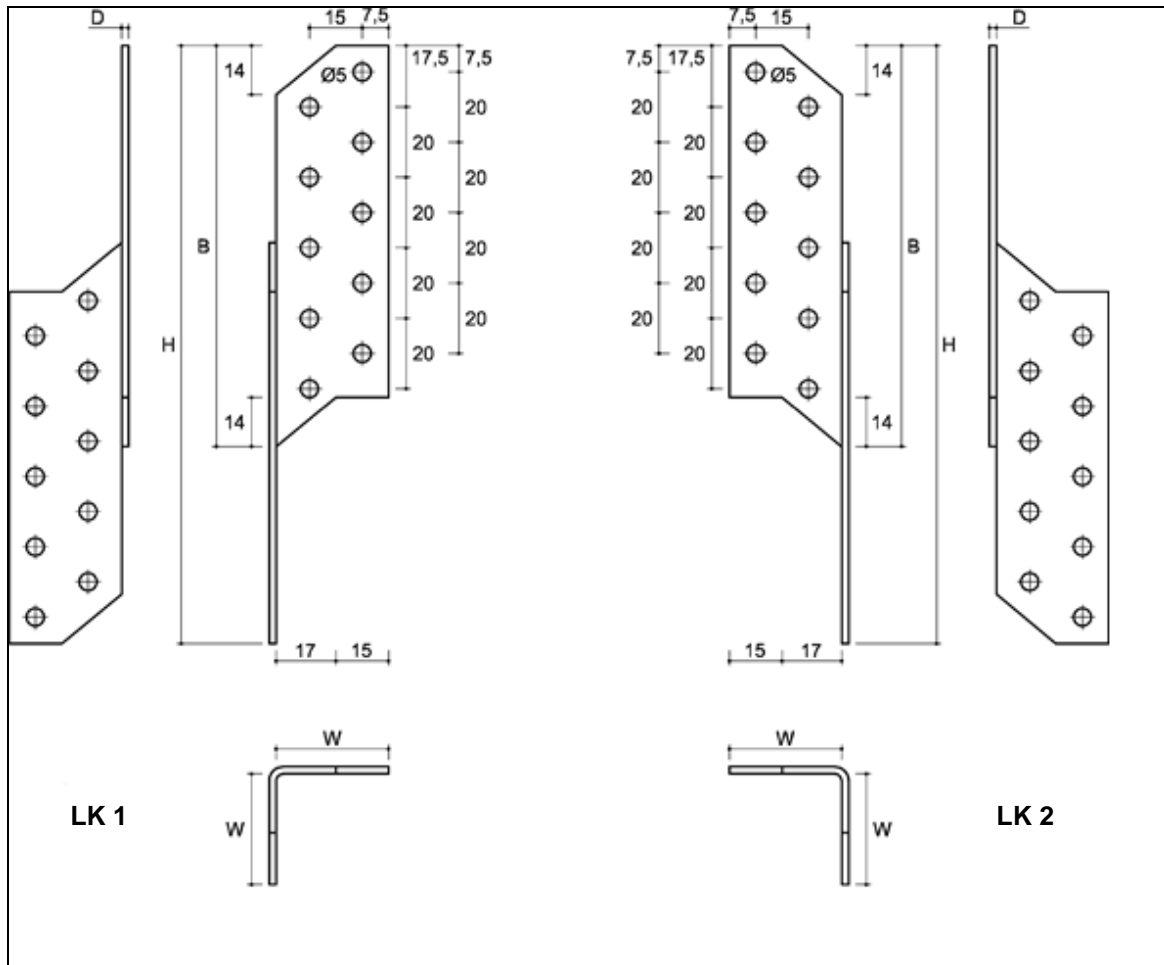


Figure 77 Type LK

Table 71 LK three-dimensional nailing plate symbols and dimensions

| Symbol | Dimensions [mm] |     |     |   | Quantity of openings | Type  |
|--------|-----------------|-----|-----|---|----------------------|-------|
|        | W               | H   | B   | D | Ø 5                  |       |
| LK 1   | 32              | 170 | 114 | 2 | 20                   | left  |
| LK 2   | 32              | 170 | 114 | 2 | 20                   | right |



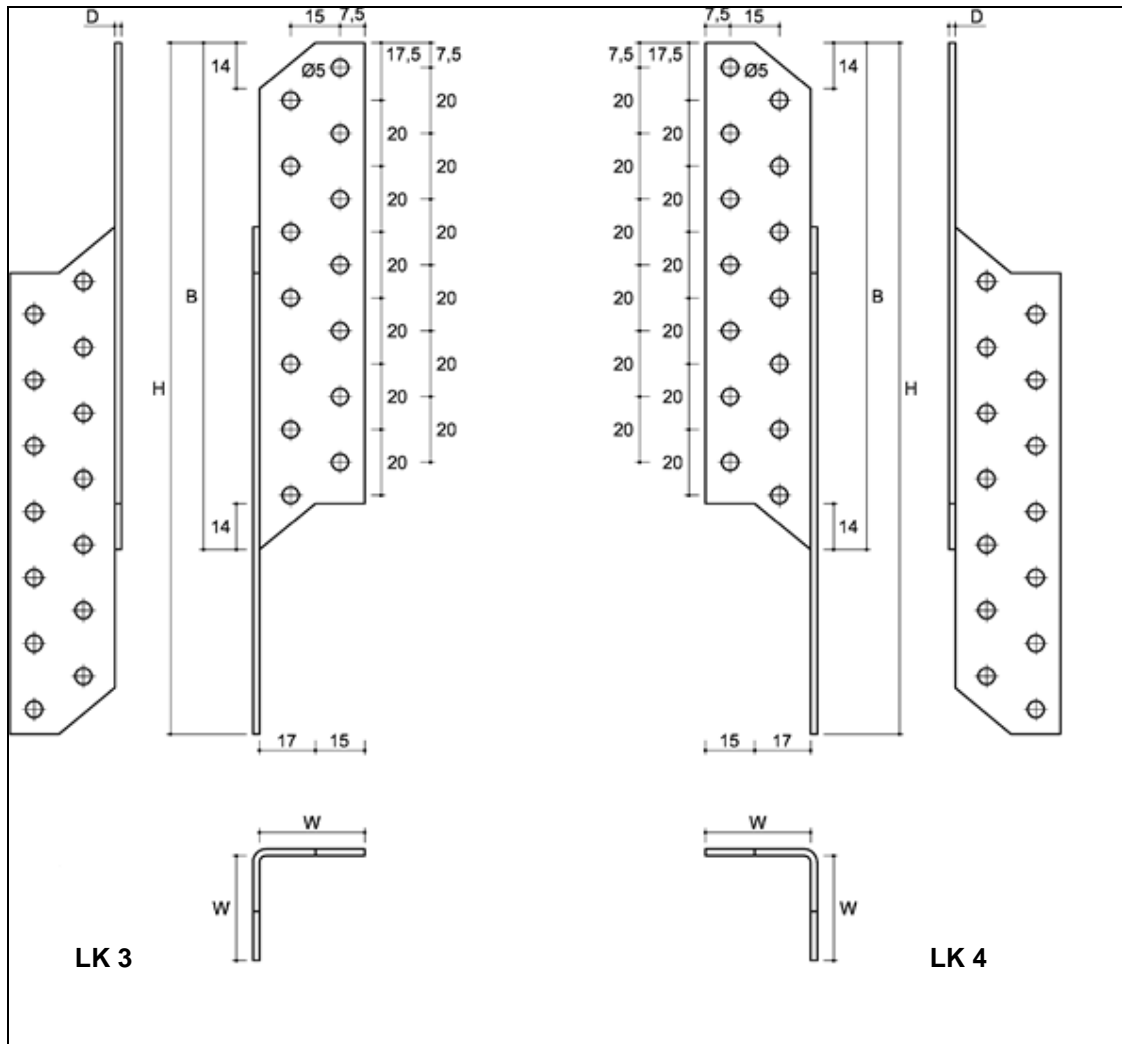
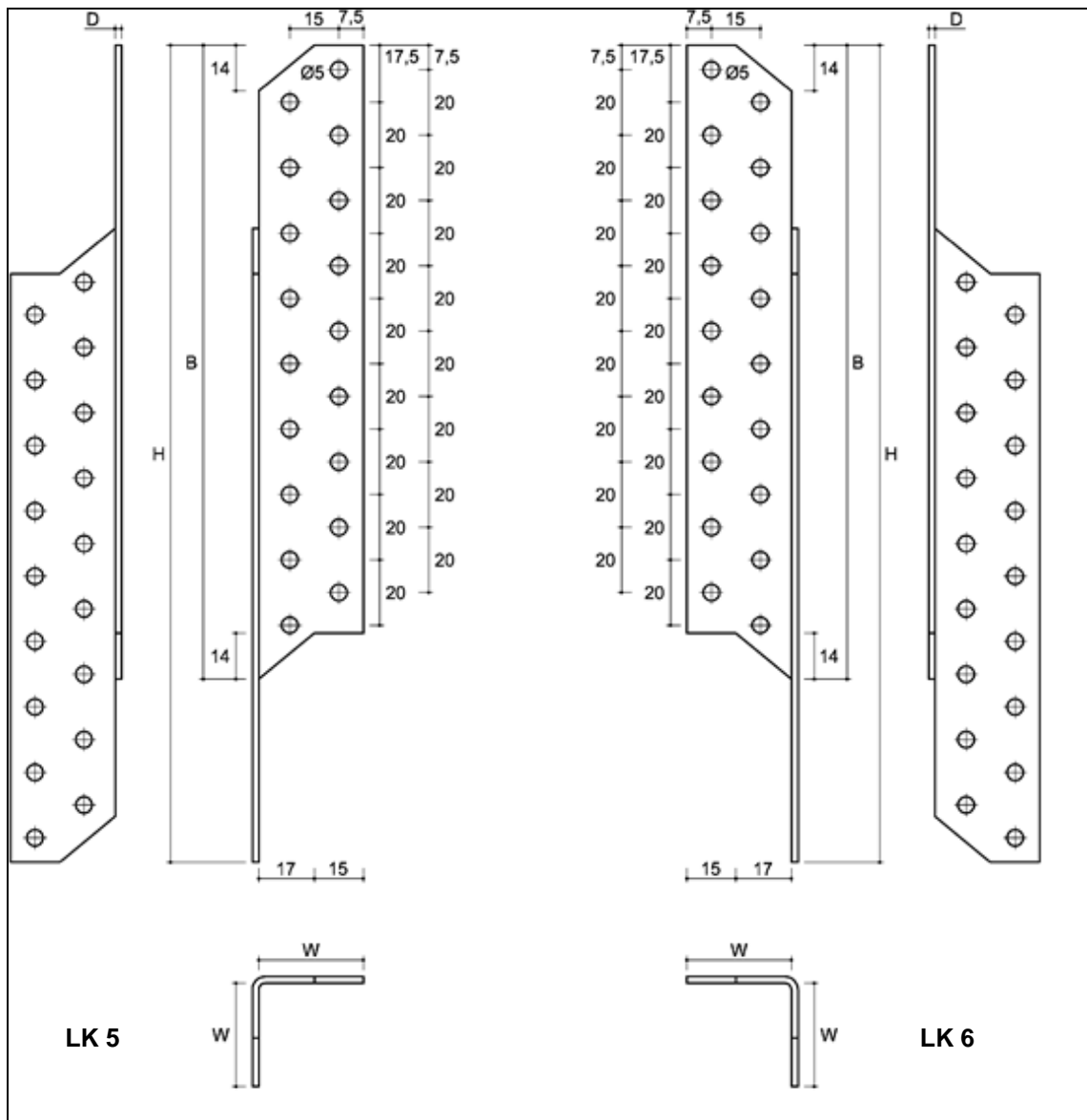


Figure 78 Type LK

Table 72 LK three-dimensional nailing plate symbols and dimensions

| Symbol | Dimensions [mm] |     |     |   | Quantity of openings<br>Ø 5 | Type  |
|--------|-----------------|-----|-----|---|-----------------------------|-------|
|        | W               | H   | B   | D |                             |       |
| LK 3   | 32              | 210 | 154 | 2 | 28                          | left  |
| LK 4   | 32              | 210 | 154 | 2 | 28                          | right |



**Figure 79** Type LK

**Table 73** LK three-dimensional nailing plate symbols and dimensions

| Symbol | Dimensions [mm] |     |     |   | Quantity of openings | Type  |
|--------|-----------------|-----|-----|---|----------------------|-------|
|        | W               | H   | B   | D | Ø 5                  |       |
| LK 5   | 32              | 250 | 194 | 2 | 36                   | left  |
| LK 6   | 32              | 250 | 194 | 2 | 36                   | right |

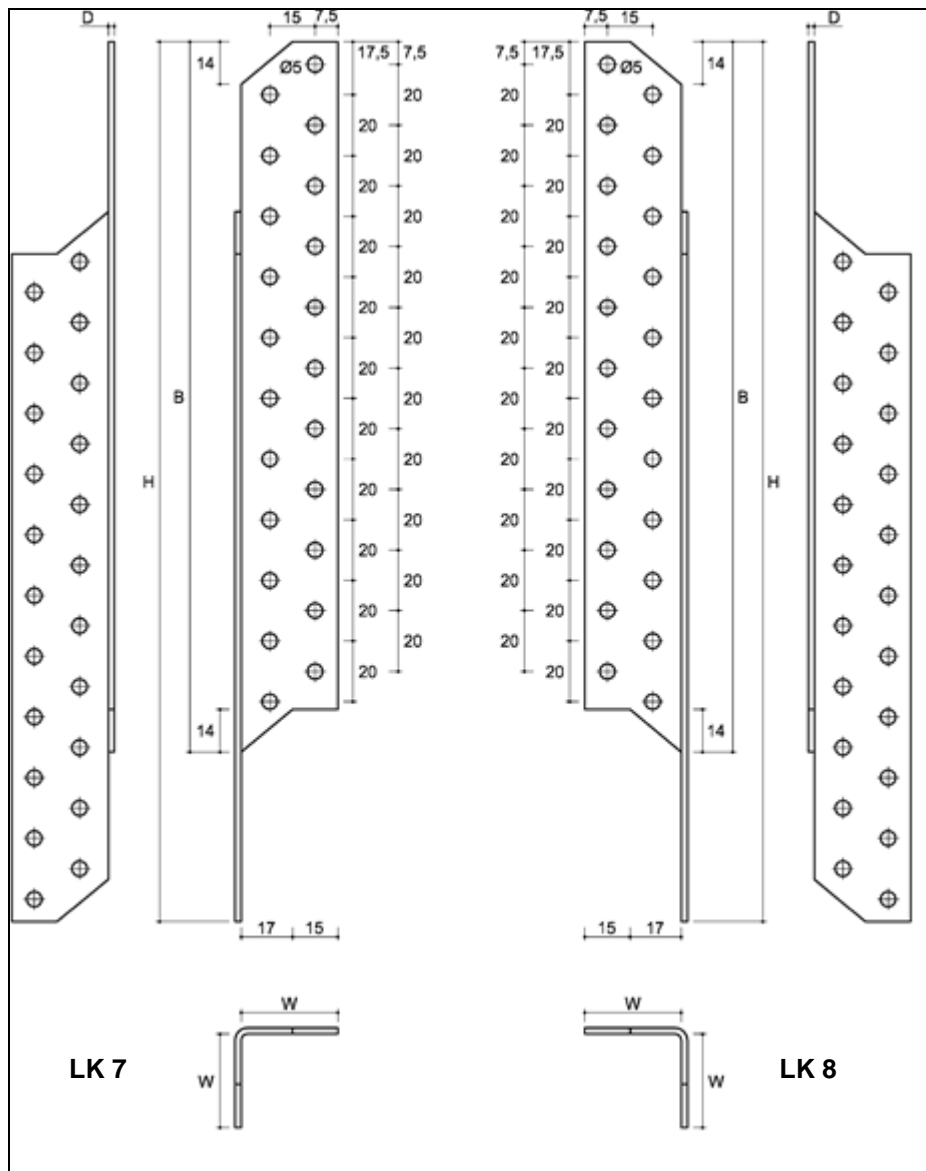
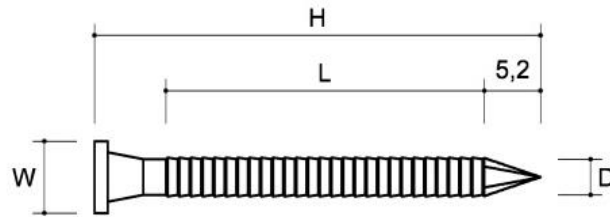


Figure 80 Type LK

Table 74 LK three-dimensional nailing plate symbols and dimensions

| Symbol | Dimensions [mm] |     |     |   | Quantity of openings<br>Ø 5 | Type  |
|--------|-----------------|-----|-----|---|-----------------------------|-------|
|        | W               | H   | B   | D |                             |       |
| LK 7   | 32              | 290 | 234 | 2 | 44                          | left  |
| LK 8   | 32              | 290 | 234 | 2 | 44                          | right |

## Specification of dowel type fasteners

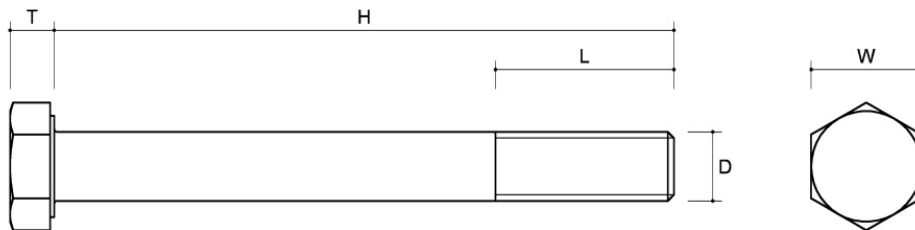


**ANG 50**

**Figure 81** Type ANG 50

**Table 75** ANG 50 dimensions

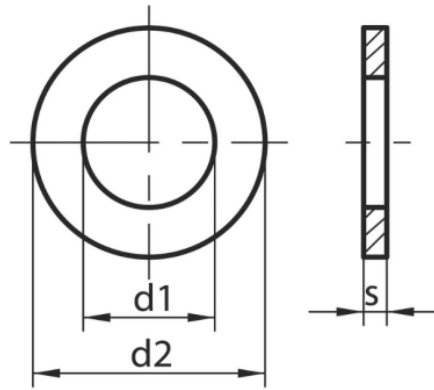
| Symbol     | Dimensions [mm] |    |      |     | Standard    | DoP No.                                   |
|------------|-----------------|----|------|-----|-------------|---|
|            | D               | H  | L    | W   |             |   |
| ANG 4x50   | 4               | 50 | 36.8 | 8   | EN 14592+A1 | DWU 30-20232 AN<br>(issued on 02/01/2018) |
| ANG 3.1x50 | 3.1             | 50 | 35   | 6.5 | EN 14592+A1 | DoP02<br>(issued on 28.05.2019)           |



**Figure 82** Bolt type M12x35

**Table 76** M bolt dimensions

| Symbol | Dimensions [mm] |    |    |    |     | Standard   | DoP No.                                    |
|--------|-----------------|----|----|----|-----|------------|--|
|        | D               | H  | L  | W  | T   |            |  |
| M12x35 | 12              | 35 | 30 | 18 | 7.5 | EN 15048-1 | NKJ/CPR/20170201<br>(issued on 01.02.2017) |



**Figure 83** Washer type M12

**Table 77** Washer M12 dimensions

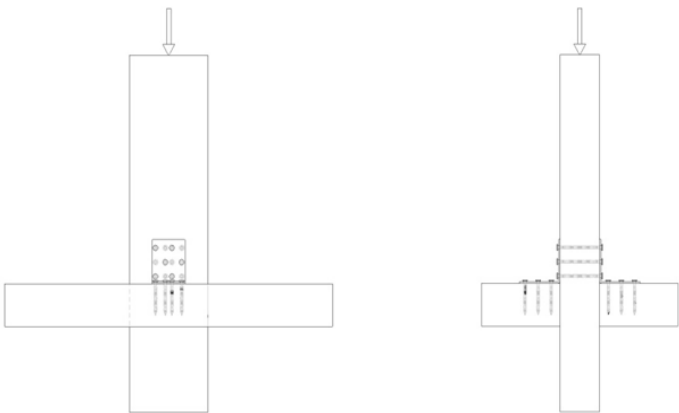
| Symbol | Dimensions [mm] |                |     | Standard   | DoP No.   |
|--------|-----------------|----------------|-----|------------|---|
|        | d <sub>1</sub>  | d <sub>2</sub> | s   |            |   |
| M12    | 13              | 24             | 2.5 | EN 15048-1 | NKJ/CPR/2015-09-01 rev.02<br>(issued on 15/01/2016) |

**THREE-DIMENSIONAL NAILING PLATES**

**LOADING ACCORDING TO STATIC DIAGRAMS**

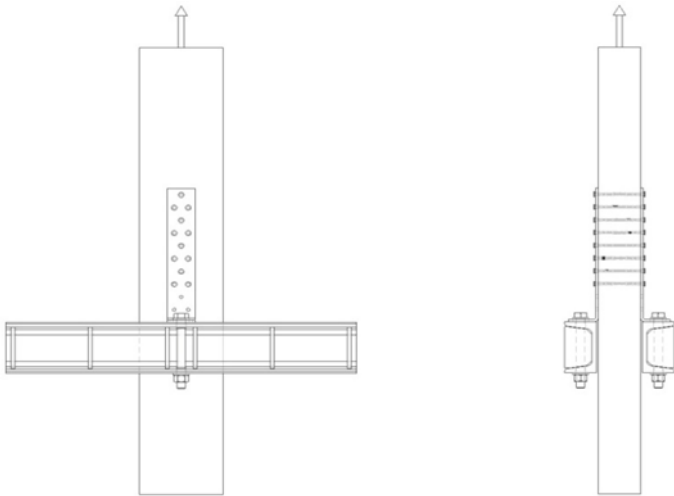
**ANNEX 2**

ETA 22/0631

| No.   | Scheme   | Connector types |        |
|-------|--|-----------------|--------|
| 1     |  | KG              | KW 1   |
|       |  | KRD 1           | KW 2   |
|       |  | KRD 2           | KW 3   |
|       |  | KRD 3           | KW 4   |
|       |  | KRD 4           | KW 5   |
|       |  | KMP 1           | KW 6   |
|       |  | KMP 2           | KW 7   |
|       |  | KMP 3           | KW 25  |
|       |  | KMP 4           | KW 30  |
|       |  | KMP 5           | KW 40  |
|       |  | KMP 6           | KW 50  |
|       |  | KMP 7           | KW 60  |
|       |  | KMP 8           | KW 80  |
|       |  | KMP 9           | KW 100 |
|       |  | KMR 1           | KW 125 |
|       |  | KMR 2           | KW 150 |
|       |  | KMR 3           | KK 1   |
|       |  | KMR 4           | KK 2   |
|       |  | KMR 5           | KK 3   |
|       |  | KMR 6           | KM 0   |
|       |  | KMR 7           | KM 1   |
|       |  | KMR 8           | KM 2   |
|       |  | KMR 9           | KM 3   |
|       |  | KMRP 1          | KM 4   |
|       |  | KMRP 2          | KM 5   |
|       |  | KMRP 3          | KM 6   |
|       |  | LZ 1            | KM 7   |
|       |  | LZ 2            | KM 8   |
|       |  | LZ 3            | KM 9   |
|       |  | KS 1            | KM 10  |
|       |  | KS 2            | KM 11  |
|       |  | KS 3            | KM 12  |
| KSO 1 | KM 13  |                 |        |
| KSO 2 | KM 14  |                 |        |
| KSO 3 | KM 15  |                 |        |
| KWO 1 | KM 19  |                 |        |
| KWO 2 | KM 20  |                 |        |
| KWO 3 | KM 21  |                 |        |
| KWO 4 | KM 1 (2.5 mm)  |                 |        |
| KB 1  | KM 2 (2.5 mm)  |                 |        |
| KB 2  | KM 4 (2.5 mm)  |                 |        |
| KB 3  | KM 5 (2.5 mm)  |                 |        |

| No. | Scheme | Connector types   |
|-----|--------|---|
|     |        | KP 1    KM 6 (2.5 mm)<br>KP 2    KM 7 (2.5 mm)<br>KP 3    KM 9 (2.5 mm)<br>KP 4    KM 10 (2.5 mm)<br>KP 5    KM 11 (2.5 mm)<br>KP 6    KM 12 (2.5 mm)<br>KP 10    KM 13 (2.5 mm)<br>KP 11    KM 14 (2.5 mm)<br>KP 12    KM 15 (2.5 mm)<br>KP 13    KM 16 (2.5 mm)<br>KP 14    KM 17 (2.5 mm)<br>KP 15    KM 18 (2.5 mm)<br>KP 21    KM 19 (2.5 mm)<br>KPL 1    KM 20 (2.5 mm)<br>KPL 2    KM 22 (2.5 mm)<br>KPL 3        KL 1<br>KPL 4        KL 2<br>KPL 10        KL 3<br>KPL 12        KL 4<br>LBS 90        KL 5<br>LBS 105        KL 101<br>KL 104<br>KL 105 |

**Figure 84** Scheme 1

| No. | Scheme   | Connector types   |
|-----|--|---|
| 2   |  | KK 21<br>KK 22<br>KK 23<br><br>LZB 95<br>LBZ 135<br>LBZ 285 |

**Figure 85** Scheme 2

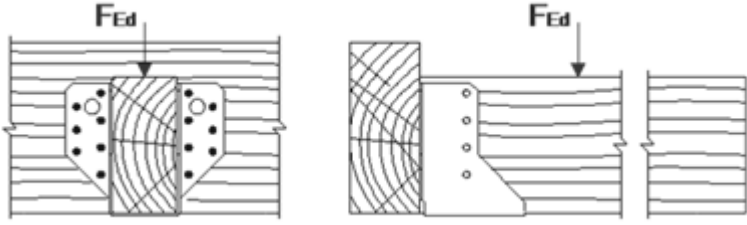
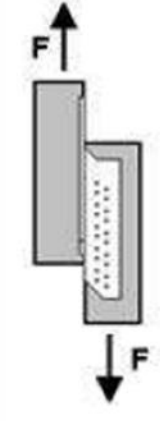
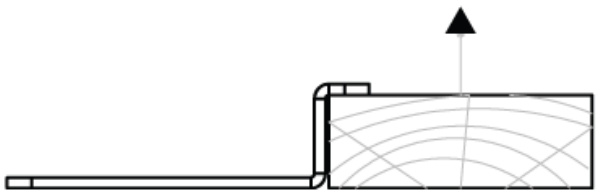
| No. | Scheme   | Connector type |          |
|-----|--|----------------|----------|
| 3   |  | WB 1           | WBZ 20   |
|     |  | WB 2           | WBZ 21   |
|     |  | WB 3           | WBZ 22   |
|     |  | WB 4           | WBZ 23   |
|     |  | WB 5           | WBZ 24   |
|     |  | WB 6           | WBZ 25   |
|     |  | WB 7           | WBZ 26   |
|     |  | WB 8           | WBZ 27   |
|     |  | WB 9           | WBZ 28   |
|     |  | WB 10          | WBZ 29   |
|     |  | WB 11          | WBZ 30   |
|     |  | WB 12          | WBZ 31   |
|     |  | WB 13          | WBZ 32   |
|     |  | WB 14          | WBZ 33   |
|     |  | WB 15          | WBZ 34   |
|     |  | WB 16          | WBZ 35   |
|     |  | WB 17          | WBZ 36   |
|     |  | WB 18          | WBZ 37   |
|     |  | WB 19          | WBD 105L |
|     |  | WB 20          | WBD 105P |
|     |  | WB 21          | WBD 130L |
|     |  | WB 22          | WBD130P  |
|     |  | WB 23          | WBD 140L |
|     |  | WB 24          | WBD 140P |
|     |  | WB 25          | WBD 170L |
|     |  | WB 26          | WBD 170P |
|     |  | WB 27          | WBD 200L |
|     |  | WB 28          | WBD 200P |
|     |  | WB 29          | WL 5     |
|     |  | WB 30          | WL 6     |
|     |  | WB 31          | WL 7     |
|     |  | WB 32          | WL 8     |
|     |  | WB 33          | WL 9     |
|     |  | WB 34          |          |
|     |  | WB 35          |          |
|     |  | WB 36          |          |
|     |  | WB 37          |          |
|     |  | WB 38          |          |
|     |  | WB 64          |          |

Figure 86 Scheme 3



| No. | Scheme  | Connector type   |
|-----|---|--|
| 4   |  | LK 1<br>LK 2<br>LK 3<br>LK 4<br>LK 5<br>LK 6<br>LK 7<br>LK 8 |

**Figure 87** Scheme 4

| No. | Scheme   | Connector type |
|-----|--|----------------|
| 5   |  | LZ 0           |

**Figure 88** Scheme 5

|   |                               |
|---|-------------------------------|
| <b>THREE-DIMENSIONAL NAILING PLATES</b>           | <b>ANNEX 3</b><br>ETA 22/0631 |
| <b>THE LOAD-CARRYING CAPACITIES OF CONNECTORS</b> |                               |

**Table 78** The load-carrying capacities of connectors

| Connector | Type of Load | Timber Moisture<br>[%] | Density              | $P_{max,mean}$           | $P_{max,k}$              | Connectors per connection | Method of determination | Document No. | Note |
|-----------|--------------|------------------------|----------------------|--------------------------|--------------------------|---------------------------|-------------------------|--------------|------|
|           |              |                        | $\rho_{mean, 12\%}$  | (350 kg·m <sup>3</sup> ) | (350 kg·m <sup>3</sup> ) |                           |                         |              |      |
|           |              |                        | [kg·m <sup>3</sup> ] | [kN]                     | [kN]                     |                           |                         |              |      |
| WB 1      | pressure     | 11±1                   | 350                  | 19.1 <sup>3</sup> /23.35 | 17.05 <sup>3</sup> /19.0 | 1                         | testing                 | LOK-672/C/06 | 1)   |
| WB 2      |              |                        |                      | 19.1 <sup>3</sup> /23.35 | 17.05 <sup>3</sup> /19.0 |                           |                         |              |      |
| WB 3      |              |                        |                      | 27.7                     | 20.3                     |                           |                         |              |      |
| WB 4      |              |                        |                      | 29.6                     | 25.45                    |                           |                         |              |      |
| WB 5      |              |                        |                      | 19.1 <sup>3</sup> /23.35 | 17.05 <sup>3</sup> /19.0 |                           |                         |              |      |
| WB 6      |              |                        |                      | 27.7                     | 20.3                     |                           |                         |              |      |
| WB 7      |              |                        |                      | 29.6                     | 25.45                    |                           |                         |              |      |
| WB 8      |              |                        |                      | 19.1 <sup>3</sup> /23.35 | 17.05 <sup>3</sup> /19.0 |                           |                         |              |      |
| WB 9      |              |                        |                      | 27.7                     | 20.3                     |                           |                         |              |      |
| WB 10     |              |                        |                      | 19.1 <sup>3</sup> /23.35 | 17.05 <sup>3</sup> /19.0 |                           |                         |              |      |
| WB 11     |              |                        |                      | 27.7                     | 20.3                     |                           |                         |              |      |
| WB 12     |              |                        |                      | 29.6                     | 25.45                    |                           |                         |              |      |
| WB 13     |              |                        |                      | 32.2                     | 27.75                    |                           |                         |              |      |
| WB 14     |              |                        |                      | 19.1 <sup>3</sup> /23.35 | 17.05 <sup>3</sup> /19.0 |                           |                         |              |      |
| WB 15     |              |                        |                      | 27.7                     | 20.3                     |                           |                         |              |      |
| WB 16     |              |                        |                      | 29.6                     | 25.45                    |                           |                         |              |      |
| WB 17     |              |                        |                      | 32.2                     | 27.75                    |                           |                         |              |      |
| WB 18     |              |                        |                      | 34.9                     | 32.3                     |                           |                         |              |      |
| WB 19     |              |                        |                      | 19.1 <sup>3</sup> /23.35 | 17.05 <sup>3</sup> /19.0 |                           |                         |              |      |
| WB 20     |              |                        |                      | 27.7                     | 20.3                     |                           |                         |              |      |

| Connector | Type of Load | Timber Moisture<br>[%] | Density              | $P_{max,mean}$            | $P_{max,k}$               | Connectors per connection | Method of determination | Document No. | Note |
|-----------|--------------|------------------------|----------------------|---------------------------|---------------------------|---------------------------|-------------------------|--------------|------|
|           |              |                        | $\rho_{mean, 12\%}$  | (350 kg·m <sup>3</sup> )  | (350 kg·m <sup>3</sup> )  |                           |                         |              |      |
|           |              |                        | [kg·m <sup>3</sup> ] | [kN]                      | [kN]                      |                           |                         |              |      |
| WB 21     |              |                        |                      | 27.7                      | 20.3                      |                           |                         |              |      |
| WB 22     |              |                        |                      | 29.6                      | 25.45                     |                           |                         |              |      |
| WB 23     |              |                        |                      | 27.7                      | 20.3                      |                           |                         |              |      |
| WB 24     |              |                        |                      | 29.6                      | 25.45                     |                           |                         |              |      |
| WB 25     |              |                        |                      | 32.2                      | 27.75                     |                           |                         |              |      |
| WB 26     |              |                        |                      | 27.7                      | 20.3                      |                           |                         |              |      |
| WB 27     |              |                        |                      | 29.6                      | 25.45                     |                           |                         |              |      |
| WB 28     |              |                        |                      | 32.2                      | 27.75                     |                           |                         |              |      |
| WB 29     |              |                        |                      | 34.9                      | 32.3                      |                           |                         |              |      |
| WB 30     |              |                        |                      | 29.6                      | 25.45                     |                           |                         |              |      |
| WB 31     |              |                        |                      | 32.2                      | 27.75                     |                           |                         |              |      |
| WB 32     |              |                        |                      | 34.9                      | 32.3                      |                           |                         |              |      |
| WB 33     |              |                        |                      | 32.2                      | 27.75                     |                           |                         |              |      |
| WB 34     |              |                        |                      | 34.9                      | 32.3                      |                           |                         |              |      |
| WB 35     |              |                        |                      | 32.2                      | 27.75                     |                           |                         |              |      |
| WB 36     |              |                        |                      | 34.9                      | 32.3                      |                           |                         |              |      |
| WB 37     |              |                        |                      | 34.9                      | 32.3                      |                           |                         |              |      |
| WB 38     |              |                        |                      | 34.9                      | 32.3                      |                           |                         |              |      |
| WB 64     |              |                        |                      | -                         | C24                       |                           |                         |              |      |
| WBZ 20    | pressure     | 13.8                   | 401                  | 32.8                      | 26.5                      | 1                         | testing                 | WBZ-R-01/23  | 1)   |
| WBZ 21    |              | 11±1                   | 350                  | 18.45 <sup>3</sup> /22.40 | 12.75 <sup>3</sup> /17.15 |                           |                         |              |      |
| WBZ 22    |              |                        |                      | 33.35 <sup>3</sup> /34.15 | 22.35 <sup>3</sup> /23.65 |                           |                         |              |      |
| WBZ 23    |              |                        |                      | 18.45 <sup>3</sup> /22.40 | 12.75 <sup>3</sup> /17.15 |                           |                         |              |      |
| WBZ 24    |              |                        |                      | 33.35 <sup>3</sup> /34.15 | 22.35 <sup>3</sup> /23.65 |                           |                         |              |      |
| WBZ 25    | 37.5         |                        |                      | 30.95                     |                           |                           |                         |              |      |

| Connector | Type of Load | Timber Moisture [%] | Density              | $P_{max,mean}$            | $P_{max,k}$               | Connectors per connection | Method of determination | Document No.  | Note |
|-----------|--------------|---------------------|----------------------|---------------------------|---------------------------|---------------------------|-------------------------|---------------|------|
|           |              |                     | $\rho_{mean, 12\%}$  | (350 kg·m <sup>3</sup> )  | (350 kg·m <sup>3</sup> )  |                           |                         |               |      |
|           |              |                     | [kg·m <sup>3</sup> ] | [kN]                      | [kN]                      |                           |                         |               |      |
| WBZ 26    |              |                     |                      | 18.45 <sup>3</sup> /22.40 | 12.75 <sup>3</sup> /17.15 |                           |                         |               |      |
| WBZ 27    |              |                     |                      | 33.35 <sup>3</sup> /34.15 | 22.35 <sup>3</sup> /23.65 |                           |                         |               |      |
| WBZ 28    |              |                     |                      | 37.5                      | 30.95                     |                           |                         |               |      |
| WBZ 29    |              |                     |                      | 31.25                     | 28.65                     |                           |                         |               |      |
| WBZ 30    |              |                     |                      | 33.35 <sup>3</sup> /34.15 | 22.35 <sup>3</sup> /23.65 |                           |                         |               |      |
| WBZ 31    |              |                     |                      | 37.5                      | 30.95                     |                           |                         |               |      |
| WBZ 32    |              |                     |                      | 31.25                     | 28.65                     |                           |                         |               |      |
| WBZ 33    |              |                     |                      | 37.5                      | 30.95                     |                           |                         |               |      |
| WBZ 34    |              |                     |                      | 31.25                     | 28.65                     |                           |                         |               |      |
| WBZ 35    |              |                     |                      | 37.5                      | 30.95                     |                           |                         |               |      |
| WBZ 36    |              |                     |                      | 31.25                     | 28.65                     |                           |                         |               |      |
| WBZ 37    |              |                     |                      | 31.25                     | 28.65                     |                           |                         |               |      |
| WBD 105L  |              |                     |                      | pressure                  | -                         |                           |                         |               |      |
| WBD 105P  |              |                     |                      |                           |                           |                           |                         |               |      |
| WBD 130L  |              |                     |                      |                           |                           |                           |                         |               |      |
| WBD130P   |              |                     |                      |                           |                           |                           |                         |               |      |
| WBD 140L  |              |                     |                      |                           |                           |                           |                         |               |      |
| WBD 140P  |              |                     |                      |                           |                           |                           |                         |               |      |
| WBD 170L  |              |                     |                      |                           |                           |                           |                         |               |      |
| WBD 170P  |              |                     |                      |                           |                           |                           |                         |               |      |
| WBD 200L  |              |                     |                      |                           |                           |                           |                         |               |      |
| WBD 200P  |              |                     |                      |                           |                           |                           |                         |               |      |
| LK 1      | pressure     | -                   | C24                  | 21.26                     | 19.36                     | 2                         | testing                 | LOK-1289/A/09 | 2)   |
| LK 2      |              |                     |                      | 22.16                     | 19.25                     |                           |                         |               |      |
| LK 3      |              |                     |                      |                           |                           |                           |                         |               |      |

| Connector | Type of Load | Timber Moisture<br>[%] | Density              | $P_{max,mean}$           | $P_{max,k}$              | Connectors per connection | Method of determination | Document No.  | Note |
|-----------|--------------|------------------------|----------------------|--------------------------|--------------------------|---------------------------|-------------------------|---------------|------|
|           |              |                        | $\rho_{mean, 12\%}$  | (350 kg·m <sup>3</sup> ) | (350 kg·m <sup>3</sup> ) |                           |                         |               |      |
|           |              |                        | [kg·m <sup>3</sup> ] | [kN]                     | [kN]                     |                           |                         |               |      |
| LK 4      |              |                        |                      |                          |                          |                           |                         |               |      |
| LK 5      |              |                        |                      |                          |                          |                           |                         |               |      |
| LK 6      |              |                        |                      |                          |                          |                           |                         |               |      |
| LK 7      |              |                        |                      |                          |                          |                           |                         |               |      |
| LK 8      |              |                        |                      |                          |                          |                           |                         |               |      |
| KG        | pressure     | 12.7                   | 421                  | 19.5                     | 14.6                     | 2                         | testing                 | KG-R-01/22    | 2)   |
| WL 5      | pressure     | -                      | C24                  | 15.5                     | 14.29                    | 1                         | testing                 | LOK-1289/A/09 | 1)   |
| WL 6      |              |                        |                      |                          |                          |                           |                         |               |      |
| WL 7      |              |                        |                      |                          |                          |                           |                         |               |      |
| WL 8      |              |                        |                      |                          |                          |                           |                         |               |      |
| WL 9      |              |                        |                      |                          |                          |                           |                         |               |      |
| KRD 1     | pressure     | 13.0                   | 413                  | 11.1                     | 7.4                      | 2                         | testing                 | KRD-R-01/22   | 2)   |
| KRD 2     |              | 12.9                   | 416                  | 12.2                     | 9.5                      |                           |                         |               |      |
| KRD 3     |              | 12.8                   | 409                  | 13.1                     | 10.8                     |                           |                         |               |      |
| KRD 4     |              |                        |                      |                          |                          |                           |                         |               |      |
| KMP 1     | pressure     | -                      | C24                  | 6.85                     | 6.2                      | 2                         | testing                 | LOK-1289/A/09 | 2)   |
| KMP 2     |              |                        |                      | 6.71                     | 5.91                     |                           |                         |               |      |
| KMP 3     |              |                        |                      | 6.92                     | 6.26                     |                           |                         |               |      |
| KMP 4     |              |                        |                      | 3.82                     | 3.41                     |                           |                         |               |      |
| KMP 5     |              |                        |                      | 6.02                     | 5.51                     |                           |                         |               |      |
| KMP 6     |              |                        |                      | 7.11                     | 6.8                      |                           |                         |               |      |
| KMP 7     |              |                        |                      | 6.12                     | 5.53                     |                           |                         |               |      |
| KMP 8     |              |                        |                      | 7.42                     | 6.57                     |                           |                         |               |      |
| KMP 9     |              |                        |                      | 12.1                     | 10.71                    |                           |                         |               |      |
| KMR 1     | pressure     | -                      | C24                  | 6.2                      | 5.52                     | 2                         | testing                 | LOK-1289/A/09 | 2)   |

| Connector | Type of Load | Timber Moisture [%] | Density              | $P_{max,mean}$           | $P_{max,k}$              | Connectors per connection | Method of determination | Document No.  | Note |
|-----------|--------------|---------------------|----------------------|--------------------------|--------------------------|---------------------------|-------------------------|---------------|------|
|           |              |                     | $\rho_{mean, 12\%}$  | (350 kg·m <sup>3</sup> ) | (350 kg·m <sup>3</sup> ) |                           |                         |               |      |
|           |              |                     | [kg·m <sup>3</sup> ] | [kN]                     | [kN]                     |                           |                         |               |      |
| KMR 2     |              |                     |                      | 8.98                     | 8.65                     |                           |                         |               |      |
| KMR 3     |              |                     |                      |                          |                          |                           |                         |               |      |
| KMR 4     |              |                     |                      |                          |                          |                           |                         |               |      |
| KMR 5     |              |                     |                      |                          |                          |                           |                         |               |      |
| KMR 6     |              |                     |                      |                          |                          |                           |                         |               |      |
| KMR 7     |              |                     |                      |                          |                          |                           |                         |               |      |
| KMR 8     |              |                     |                      |                          |                          |                           |                         |               |      |
| KMR 9     |              |                     |                      |                          |                          |                           |                         |               |      |
| KMRP 1    |              |                     |                      |                          |                          |                           |                         |               |      |
| KMRP 2    | 8.33         | 6.9                 |                      |                          |                          |                           |                         |               |      |
| KMRP 3    | 8.08         | 7.4                 |                      |                          |                          |                           |                         |               |      |
| LZ 0      | pull out     | -                   | C24                  | -                        | 1.3                      | 1                         | calculation             | LZ0-O-01/22   | 1)   |
| LZ 1      | pressure     | -                   | C24                  | 4.02                     | 3.62                     | 2                         | testing                 | LOK-1289/A/09 | 2)   |
| LZ 2      |              |                     |                      |                          |                          |                           |                         |               |      |
| LZ 3      |              |                     |                      |                          |                          |                           |                         |               |      |
| KS 1      | pressure     | -                   | C24                  | 3.68                     | 3.44                     | 2                         | testing                 | LOK-1289/A/09 | 2)   |
| KS 2      |              |                     |                      | 7.04                     | 6.65                     |                           |                         |               |      |
| KS 3      |              |                     |                      |                          |                          |                           |                         |               |      |
| KSO 1     | pressure     | -                   | C24                  | 3.95                     | 3.49                     | 2                         | testing                 | LOK-1289/A/09 | 2)   |
| KSO 2     |              |                     |                      | 7.28                     | 6.58                     |                           |                         |               |      |
| KSO 3     |              |                     |                      |                          |                          |                           |                         |               |      |
| KWO 1     | pressure     | -                   | C24                  | 2.9                      | 2.51                     | 2                         | testing                 | LOK-1289/A/09 | 2)   |
| KWO 2     |              |                     |                      |                          |                          |                           |                         |               |      |
| KWO 3     |              |                     |                      |                          |                          |                           |                         |               |      |
| KWO 4     |              |                     |                      |                          |                          |                           |                         |               |      |

| Connector | Type of Load | Timber Moisture<br>[%] | Density              | $P_{max,mean}$           | $P_{max,k}$              | Connectors per connection | Method of determination | Document No.               | Note |
|-----------|--------------|------------------------|----------------------|--------------------------|--------------------------|---------------------------|-------------------------|----------------------------|------|
|           |              |                        | $\rho_{mean, 12\%}$  | (350 kg·m <sup>3</sup> ) | (350 kg·m <sup>3</sup> ) |                           |                         |                            |      |
|           |              |                        | [kg·m <sup>3</sup> ] | [kN]                     | [kN]                     |                           |                         |                            |      |
| KB 1      | pressure     | -                      | C24                  | 7.84                     | 7.46                     | 2                         | testing                 | LOK-1289/A/09              | 2)   |
| KB 2      |              |                        |                      | 9.04                     | 8.62                     |                           |                         |                            |      |
| KB 3      |              |                        |                      |                          |                          |                           |                         |                            |      |
| KP 1      | pressure     | 12.5                   | 413                  | 32.6                     | 27.2                     | 2                         | testing                 | KP-R-01/22<br>KP-R-01/23   | 2)   |
| KP 2      |              | 12.7                   | 404                  | 40.5                     | 35.2                     |                           |                         |                            |      |
| KP 3      |              | 12.9                   | 403                  | 29.5                     | 23.1                     |                           |                         |                            |      |
| KP 4      |              | 12.7                   | 414                  | 23.7                     | 19.6                     |                           |                         |                            |      |
| KP 5      |              | 12.9                   | 424                  | 35.7                     | 25.7                     |                           |                         |                            |      |
| KP 6      |              | 12.8                   | 407                  | 43.3                     | 34.6                     |                           |                         |                            |      |
| KP 10     |              | 12.6                   | 405                  | 43.5                     | 38.4                     |                           |                         |                            |      |
| KP 11     |              | 12.6                   | 405                  | 28.5                     | 23.1                     |                           |                         |                            |      |
| KP 12     |              | 12.7                   | 410                  | 38.3                     | 33.8                     |                           |                         |                            |      |
| KP 13     |              | 12.9                   | 405                  | 37.4                     | 32.5                     |                           |                         |                            |      |
| KP 14     |              | 12.9                   | 405                  | 38.8                     | 31.1                     |                           |                         |                            |      |
| KP 15     |              | 12.7                   | 412                  | 18.7                     | 16.5                     |                           |                         |                            |      |
| KP 21     |              | 12.6                   | 403                  | 38.3                     | 31                       |                           |                         |                            |      |
| KPL 1     | pressure     | 12.7                   | 401                  | 28.2                     | 22.3                     | 2                         | testing                 | KPL-R-01/22<br>KPL-R-01/23 | 2)   |
| KPL 2     |              | 12.5                   | 409                  | 38.4                     | 28.4                     |                           |                         |                            |      |
| KPL 3     |              | 12.7                   | 424                  | 23.9                     | 20.5                     |                           |                         |                            |      |
| KPL 4     |              | 12.8                   | 405                  | 21.2                     | 18.5                     |                           |                         |                            |      |
| KPL 10    |              | 12.8                   | 411                  | 37.5                     | 31.8                     |                           |                         |                            |      |
| KPL 12    |              | 12.8                   | 400                  | 31.8                     | 27.9                     |                           |                         |                            |      |
| KL 1      | pressure     | 12.7                   | 410                  | 14                       | 11                       | 2                         | testing                 | KL-R-01/22<br>KL-R-01/23   | 2)   |
| KL 2      |              | 12.8                   | 401                  | 24.4                     | 20.2                     |                           |                         |                            |      |
| KL 3      |              | 12.7                   | 406                  | 17.7                     | 15.2                     |                           |                         |                            |      |
| KL 4      |              | 13                     | 401                  | 24.8                     | 21.9                     |                           |                         |                            |      |

| Connector | Type of Load | Timber Moisture | Density                    | $P_{\max, \text{mean}}$  | $P_{\max, k}$            | Connectors per connection | Method of determination | Document No. | Note |
|-----------|--------------|-----------------|----------------------------|--------------------------|--------------------------|---------------------------|-------------------------|--------------|------|
|           |              |                 | $\rho_{\text{mean}, 12\%}$ | (350 kg·m <sup>3</sup> ) | (350 kg·m <sup>3</sup> ) |                           |                         |              |      |
|           |              |                 | [%]                        | [kg·m <sup>3</sup> ]     | [kN]                     |                           |                         |              |      |
| KL 5      |              | 12.9            | 405                        | 31.2                     | 27.6                     |                           |                         |              |      |
| KL 101    |              | 12.8            | 414                        | 14.2                     | 10.2                     |                           |                         |              |      |
| KL 104    |              | 12.7            | 406                        | 24.9                     | 18.8                     |                           |                         |              |      |
| KL 105    |              | 12.6            | 402                        | 28.3                     | 21.9                     |                           |                         |              |      |
| KW 1      | pressure     | 12.8            | 413                        | 7.2                      | 6                        | 2                         | testing                 | KW-R-01/22   | 2)   |
| KW 2      |              |                 |                            |                          |                          |                           |                         |              |      |
| KW 3      |              | 12.9            | 402                        | 7.3                      | 5.5                      |                           |                         |              |      |
| KW 4      |              |                 |                            |                          |                          |                           |                         |              |      |
| KW 5      |              |                 |                            |                          |                          |                           |                         |              |      |
| KW 6      |              | 12.7            | 409                        | 12.6                     | 10.9                     |                           |                         |              |      |
| KW 7      |              |                 |                            |                          |                          |                           |                         |              |      |
| KW 25     |              | 12.7            | 430                        | 14.7                     | 11.1                     |                           |                         |              |      |
| KW 30     |              |                 |                            |                          |                          |                           |                         |              |      |
| KW 40     |              |                 |                            |                          |                          |                           |                         |              |      |
| KW 50     |              |                 |                            |                          |                          |                           |                         |              |      |
| KW 60     |              | 12.6            | 407                        | 7.6                      | 5.6                      |                           |                         |              |      |
| KW 80     |              |                 |                            |                          |                          |                           |                         |              |      |
| KW 100    |              |                 |                            |                          |                          |                           |                         |              |      |
| KW 125    |              |                 |                            |                          |                          |                           |                         |              |      |
| KW 150    |              | 12.9            | 410                        | 9.7                      | 7.6                      |                           |                         |              |      |
|           |              |                 |                            |                          |                          |                           |                         |              |      |
| KK 1      | pressure     | 12.9            | 400                        | 14.4                     | 11.6                     | 2                         | testing                 | KK-R-01/22   |      |
| KK 2      |              | 12.7            | 405                        | 16.6                     | 13.1                     |                           |                         |              |      |
| KK 3      |              | 12.8            | 400                        | 16.6                     | 14.7                     |                           |                         |              |      |
| KK 21     | pull out     | 12.9            | 405                        | 25.5                     | 19.9                     |                           |                         | KK-R-02/22   |      |
| KK 22     |              | 12.8            | 420                        | 27.4                     | 22.5                     |                           |                         |              |      |



| Connector     | Type of Load | Timber Moisture<br>[%] | Density              | $P_{max,mean}$           | $P_{max,k}$              | Connectors per connection | Method of determination | Document No.  | Note |
|---------------|--------------|------------------------|----------------------|--------------------------|--------------------------|---------------------------|-------------------------|---------------|------|
|               |              |                        | $\rho_{mean, 12\%}$  | (350 kg·m <sup>3</sup> ) | (350 kg·m <sup>3</sup> ) |                           |                         |               |      |
|               |              |                        | [kg·m <sup>3</sup> ] | [kN]                     | [kN]                     |                           |                         |               |      |
| KK 23         |              | 12.8                   | 420                  | 29.3                     | 25.9                     |                           |                         |               |      |
| KM 0          | pressure     | 12.7                   | 411                  | 8.8                      | 7.2                      | 2                         | testing                 | KM-R-01/23    | 2)   |
| KM 1          |              | -                      | C24                  | -                        | 14                       |                           | calculation             | KM-O-01/22    |      |
| KM 2          |              | -                      | C24                  | -                        | 14                       |                           |                         |               |      |
| KM 3          |              | 12.8                   | 410                  | 16.1                     | 14                       |                           | testing                 | KM-R-01/22    |      |
| KM 4          |              | -                      | C24                  | -                        | 15.2                     |                           |                         |               |      |
| KM 5          |              | -                      | C24                  | -                        | 19.88                    |                           | calculation             | KM-O-01/22    |      |
| KM 6          |              | 12.7                   | 403                  | 31.6                     | 26.3                     |                           | testing                 | KM-R-01/22    |      |
| KM 7          |              | -                      | C24                  | -                        | 14.8                     |                           | calculation             | KM-O-01/22    |      |
| KM 8          |              | 12.8                   | 413                  | 19.2                     | 15.6                     |                           | testing                 | KM-R-01/22    |      |
| KM 9          |              | -                      | C24                  | -                        | 26.83                    |                           | calculation             | KM-O-01/22    |      |
| KM 10         |              | 12.8                   | 413                  | 32.9                     | 27.9                     |                           | testing                 | KM-R-01/22    |      |
| KM 11         |              | -                      | C24                  | -                        | 19.88                    |                           |                         |               |      |
| KM 12         |              | -                      | C24                  | -                        | 28.54                    |                           | calculation             | KM-O-01/22    |      |
| KM 13         |              | 12.6                   | 410                  | 33.4                     | 29.5                     |                           | testing                 | KM-R-01/22    |      |
| KM 14         |              | -                      | C24                  | -                        | 14.8                     |                           |                         |               |      |
| KM 15         |              | -                      | C24                  | -                        | 24.16                    |                           |                         |               |      |
| KM 19         |              | -                      | C                    | -                        | 15.2                     |                           | calculation             | KM-O-01/22    |      |
| KM 20         |              | -                      | C24                  | -                        | 13.6                     |                           |                         |               |      |
| KM 21         | 12.5         | 400                    | 17.3                 | 15.1                     | testing                  | KM-R-01/23                |                         |               |      |
| KM 1 (2.5 mm) | pressure     | -                      | C24                  | -                        | 15                       | 2                         | calculation             | KM2,5-O-01/22 | 2)   |
| KM 2 (2.5 mm) |              | 12.6                   | 411                  | 17.2                     | 15                       |                           | testing                 | KM2,5-R-01/22 |      |
| KM 4 (2.5 mm) |              | -                      | C24                  | -                        | 17.8                     |                           |                         |               |      |
| KM 5 (2.5 mm) |              | -                      | C24                  | -                        | 22.9                     |                           | calculation             | KM2,5-O-01/22 |      |
| KM 6 (2.5 mm) |              | 12.7                   | 411                  | 34.4                     | 28                       |                           |                         |               |      |
| KM 7 (2.5 mm) |              | 12.8                   | 408                  | 19.2                     | 16.1                     |                           | testing                 | KM2,5-R-01/22 |      |

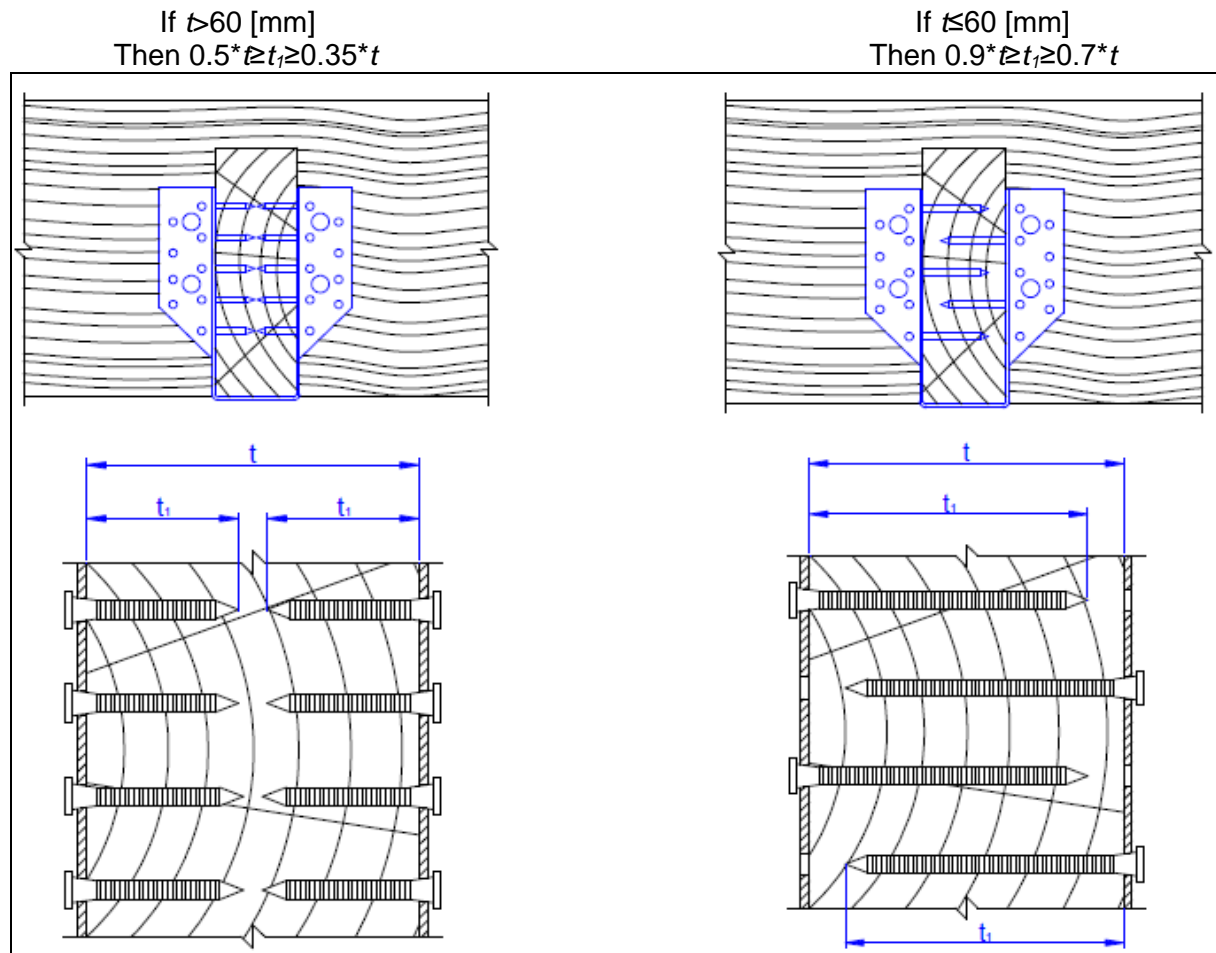
| Connector      | Type of Load | Timber Moisture<br>[%] | Density              | $P_{max,mean}$           | $P_{max,k}$              | Connectors per connection | Method of determination | Document No.  | Note |
|----------------|--------------|------------------------|----------------------|--------------------------|--------------------------|---------------------------|-------------------------|---------------|------|
|                |              |                        | $\rho_{mean, 12\%}$  | (350 kg·m <sup>3</sup> ) | (350 kg·m <sup>3</sup> ) |                           |                         |               |      |
|                |              |                        | [kg·m <sup>3</sup> ] | [kN]                     | [kN]                     |                           |                         |               |      |
| KM 9 (2.5 mm)  |              | -                      | C24                  | -                        | 28.53                    |                           | calculation             | KM2,5-O-01/22 |      |
| KM 10 (2.5 mm) |              | 12.9                   | 411                  | 33.9                     | 29.6                     |                           | testing                 | KM2,5-R-01/22 |      |
| KM 11 (2.5 mm) |              | -                      | C24                  | -                        | 22.9                     |                           | calculation             | KM2,5-O-01/22 |      |
| KM 12 (2.5 mm) |              | -                      | C24                  | -                        | 30.68                    |                           | testing                 | KM2,5-R-01/22 |      |
| KM 13 (2.5 mm) |              | 12.9                   | 410                  | 37.6                     | 32.3                     |                           |                         |               |      |
| KM 14 (2.5 mm) |              | -                      | C24                  | -                        | 16.1                     |                           | calculation             | KM2,5-O-01/22 |      |
| KM 15 (2.5 mm) |              | -                      | C24                  | -                        | 26.3                     |                           |                         |               |      |
| KM 16 (2.5 mm) |              | -                      | C24                  | -                        | 16.1                     |                           |                         |               |      |
| KM 17 (2.5 mm) |              | -                      | C24                  | -                        | 15                       |                           |                         |               |      |
| KM 18 (2.5 mm) |              | -                      | C24                  | -                        | 16.1                     |                           |                         |               |      |
| KM 19 (2.5 mm) |              | -                      | C24                  | -                        | 17.8                     |                           |                         |               |      |
| KM 20 (2.5 mm) |              | -                      | C24                  | -                        | 14.45                    |                           |                         |               |      |
| KM 22 (2.5 mm) |              | 12.7                   | 406                  | 23.7                     | 20.9                     |                           |                         |               |      |
| LBS 90         | pressure     | 12.8                   | 413                  | 20.7                     | 18.3                     | 2                         | testing                 | LBS-R-01/23   | 2)   |
| LBS 105        |              | 12.6                   | 404                  | 30.4                     | 26.3                     |                           |                         |               |      |
| LBZ 95         | pull out     | 13                     | 407                  | 21.7                     | 18.4                     | 2                         | testing                 | LBZ-R-01/22   | 2)   |
| LBZ 135        |              | 13                     | 432                  | 37                       | 29.2                     |                           |                         |               |      |
| LBZ 285        |              | -                      | C24                  | -                        | 50.6                     |                           | calculation             | LBZ-O-01/22   |      |

1) The forces are given for the complete connection consisting of one connector.

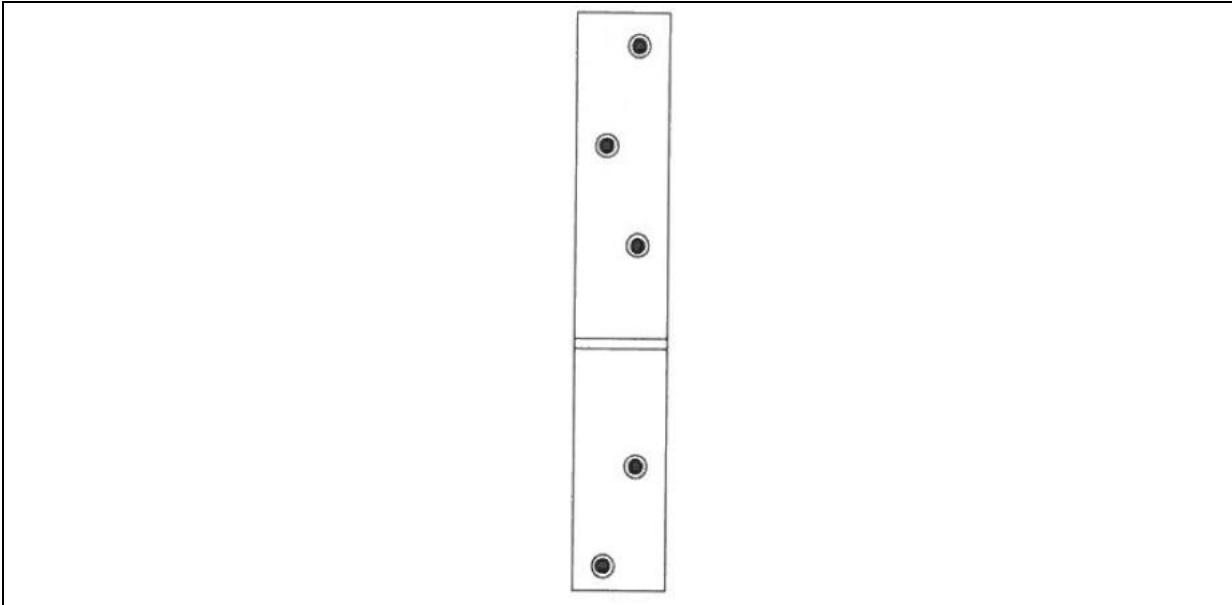
2) The forces are given for the complete connection consisting of two connectors, hence force per one connector (one angle bracket) is half of the given value.

3) Partial nailing acc. to DMX-G-01/22

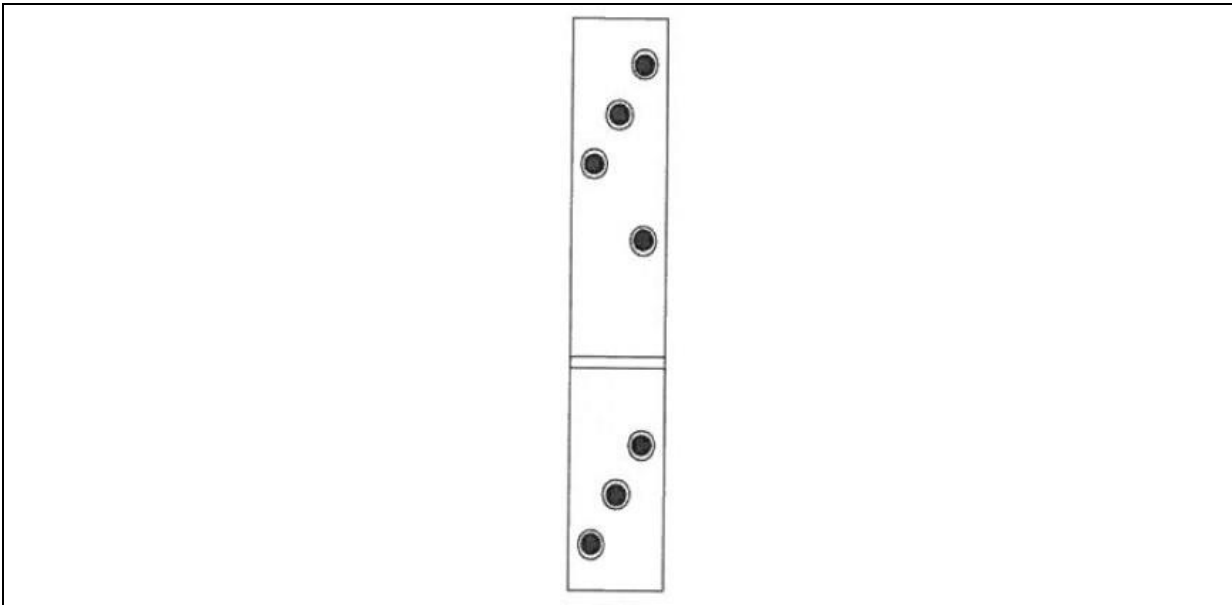
It is always necessary to put nails in the black marked holes. This is the only one proper pattern. Too many or too long nails can weaken the wood, when are quite close to edge (rule is stated below).



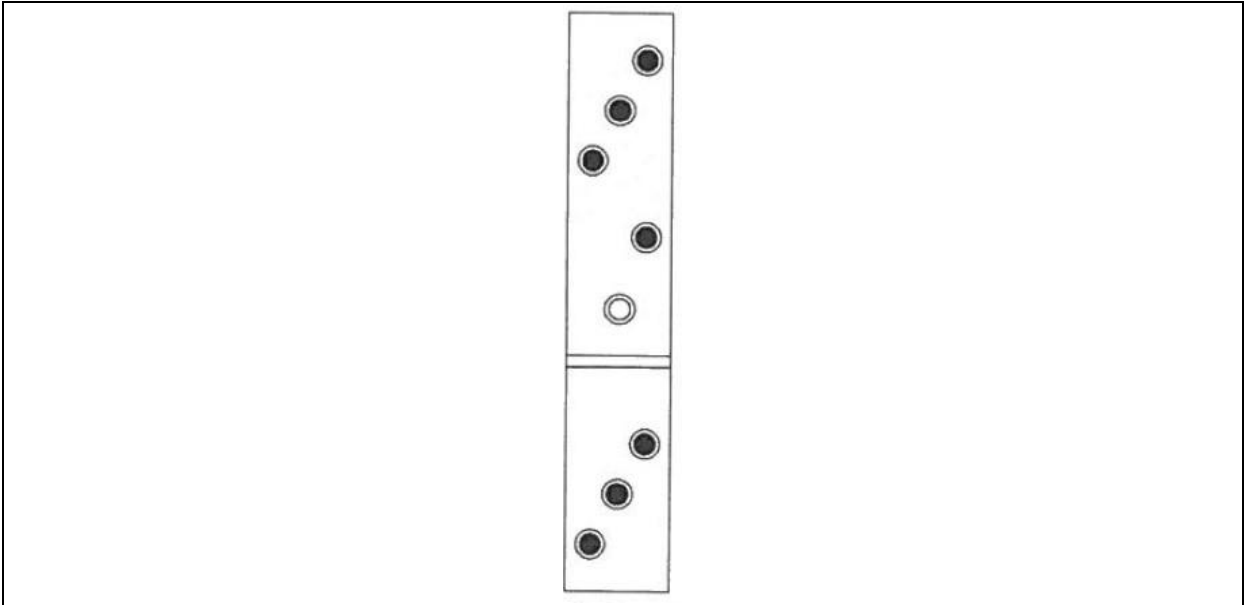
**Figure 89** Rule for placement nails



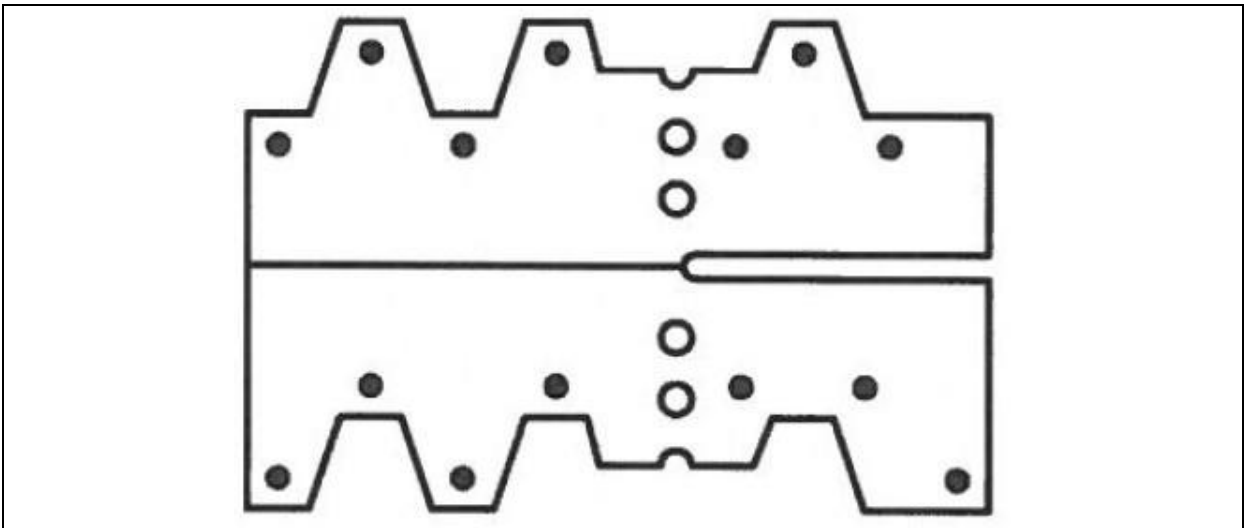
**Figure 90** Type KB 1



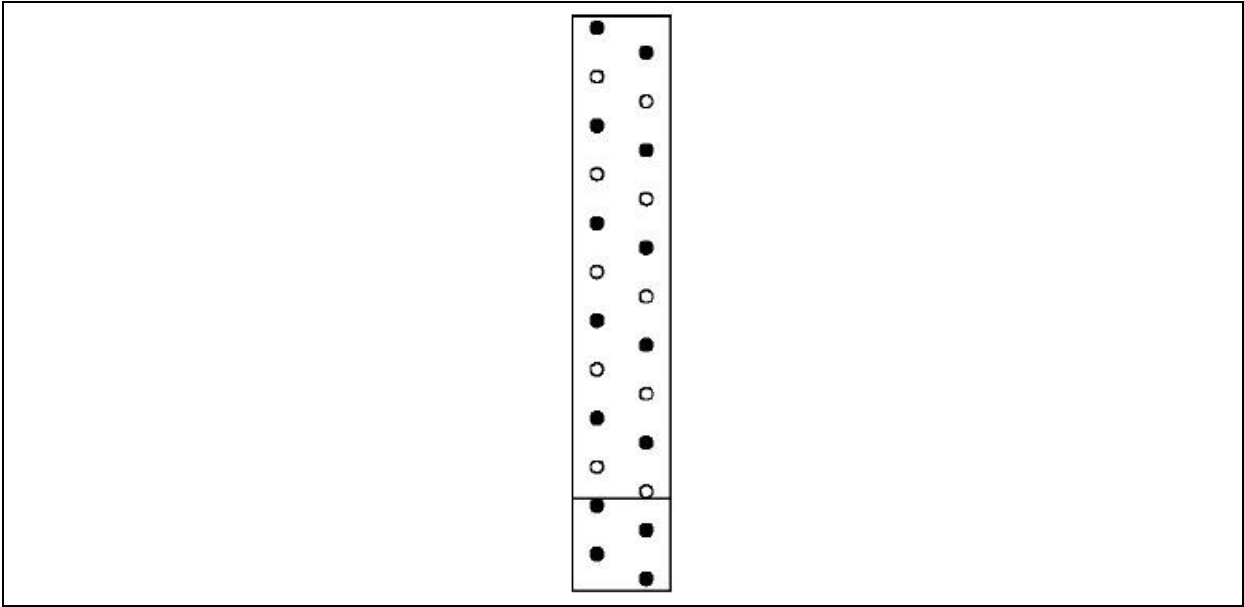
**Figure 91** Type KB 2



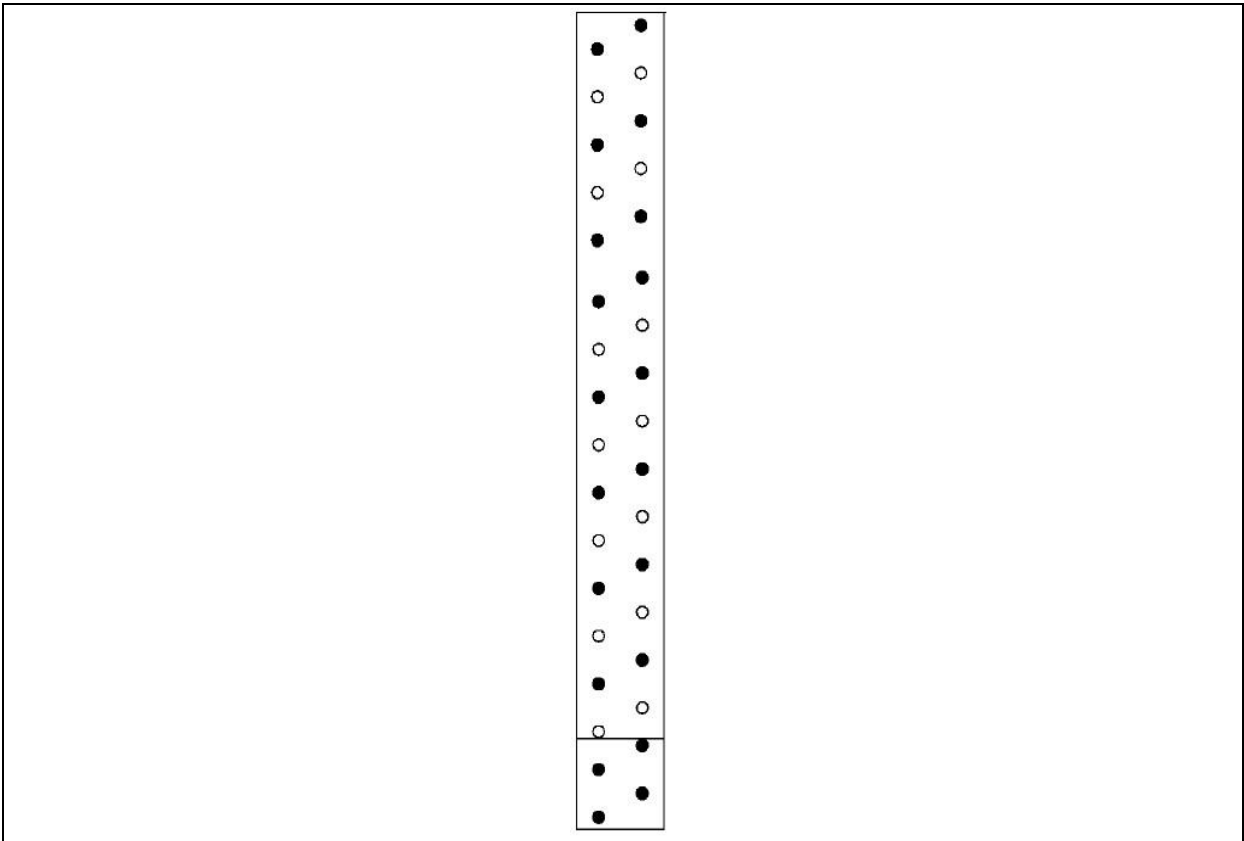
**Figure 92** Type KB 3



**Figure 93** Type KG



**Figure 94** Type KK 1



**Figure 95** Type KK 2

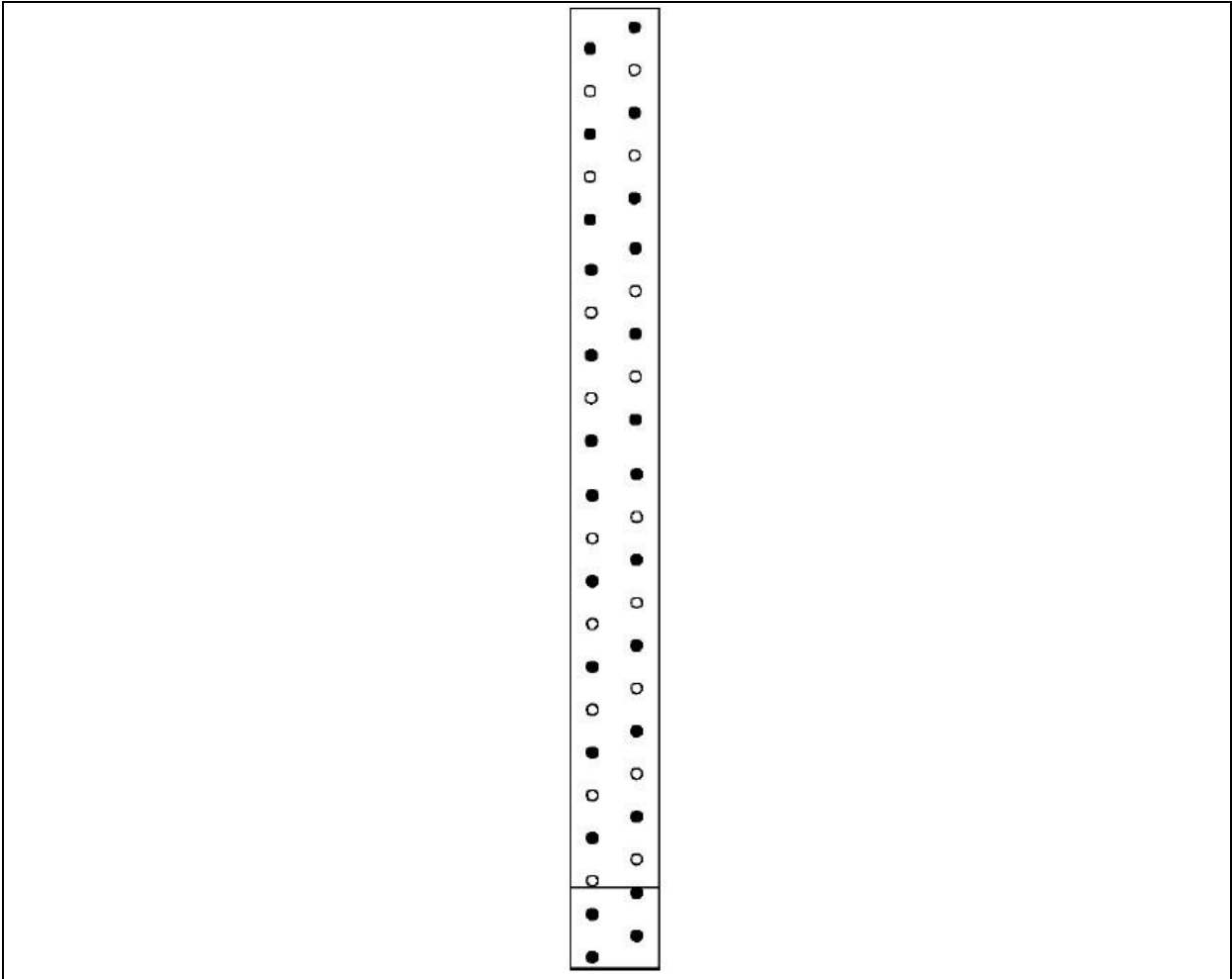


Figure 96 Type KK 3

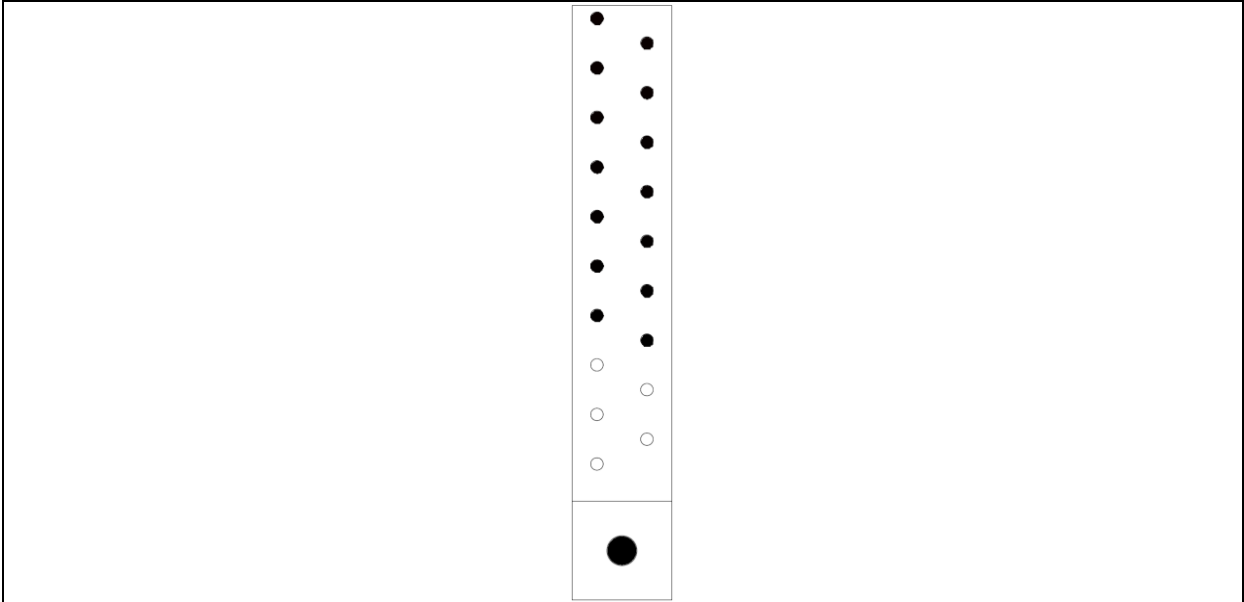


Figure 97 Type KK 21

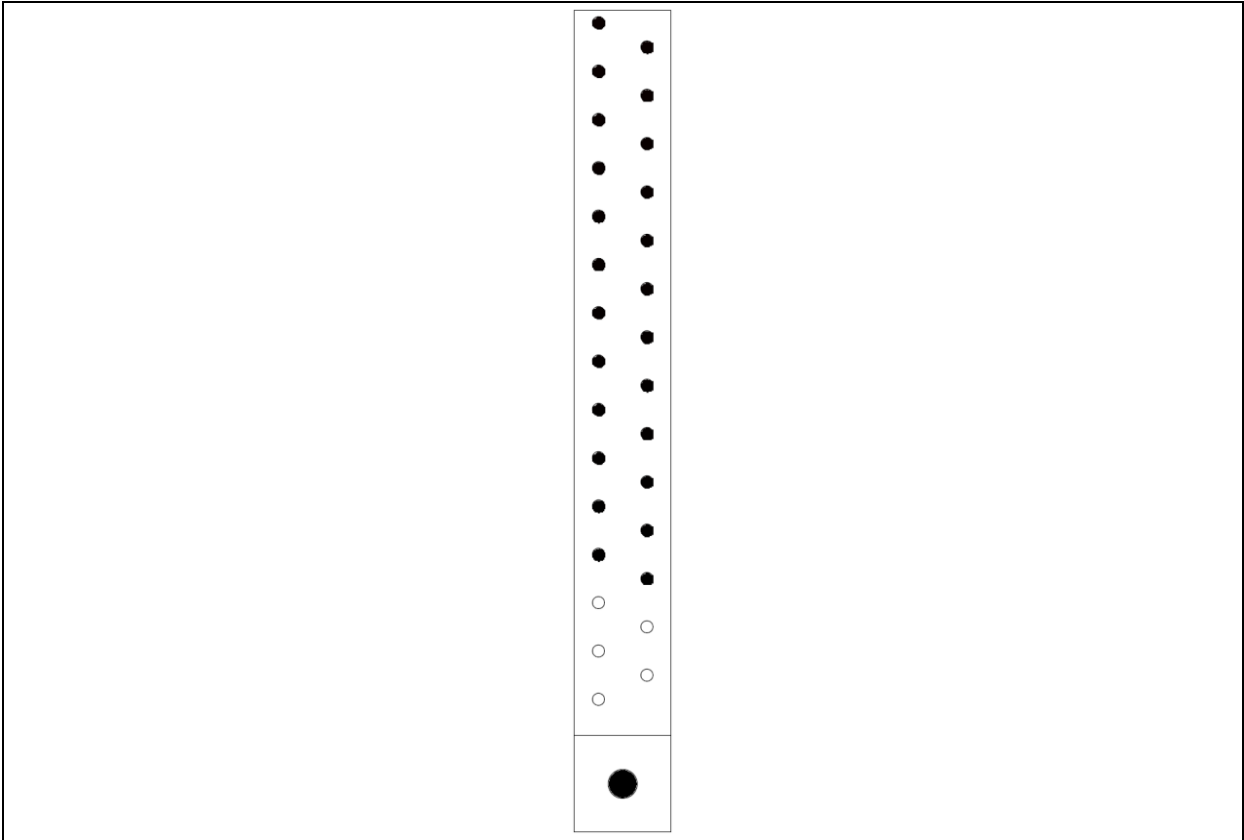


Figure 98 Type KK 22

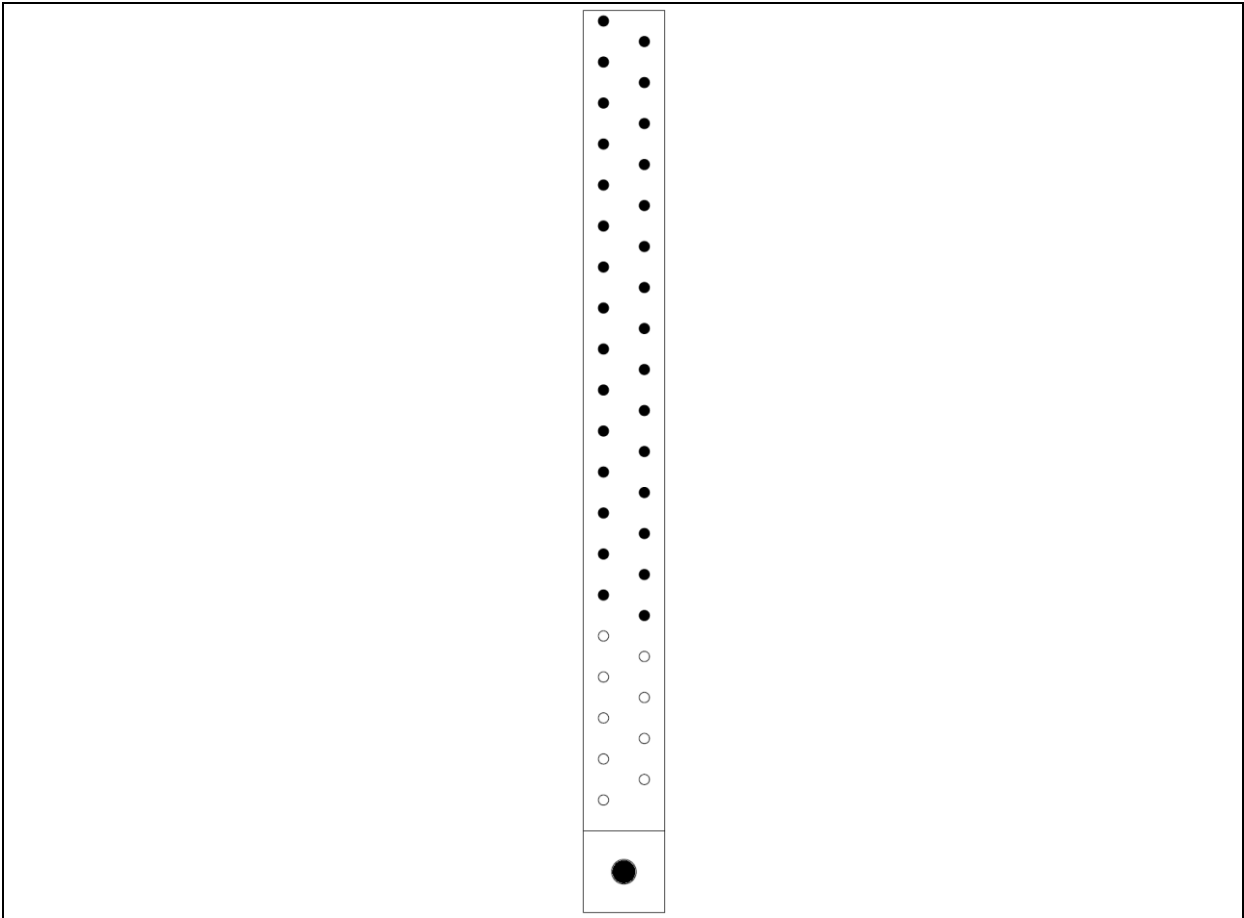


Figure 99 Type KK 23



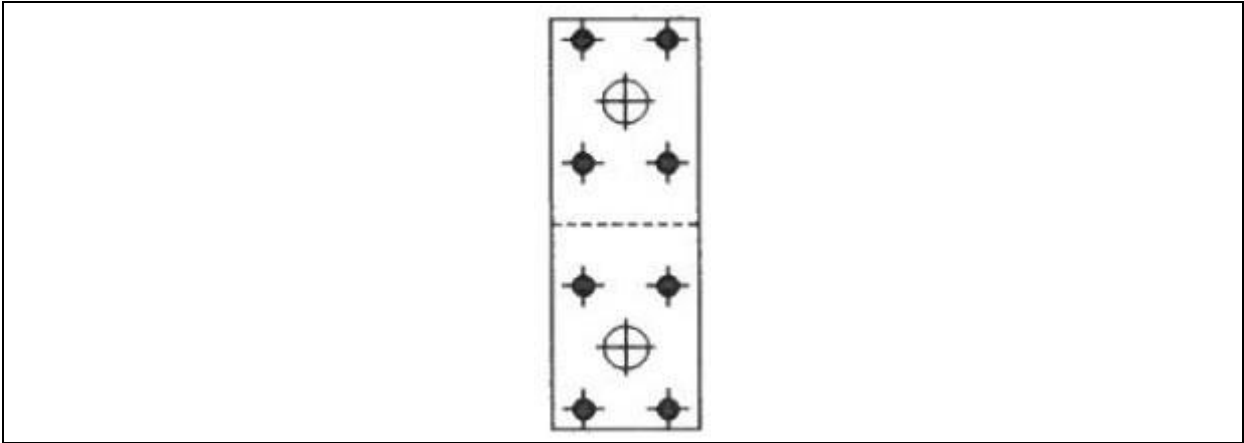


Figure 100 Type KL 1

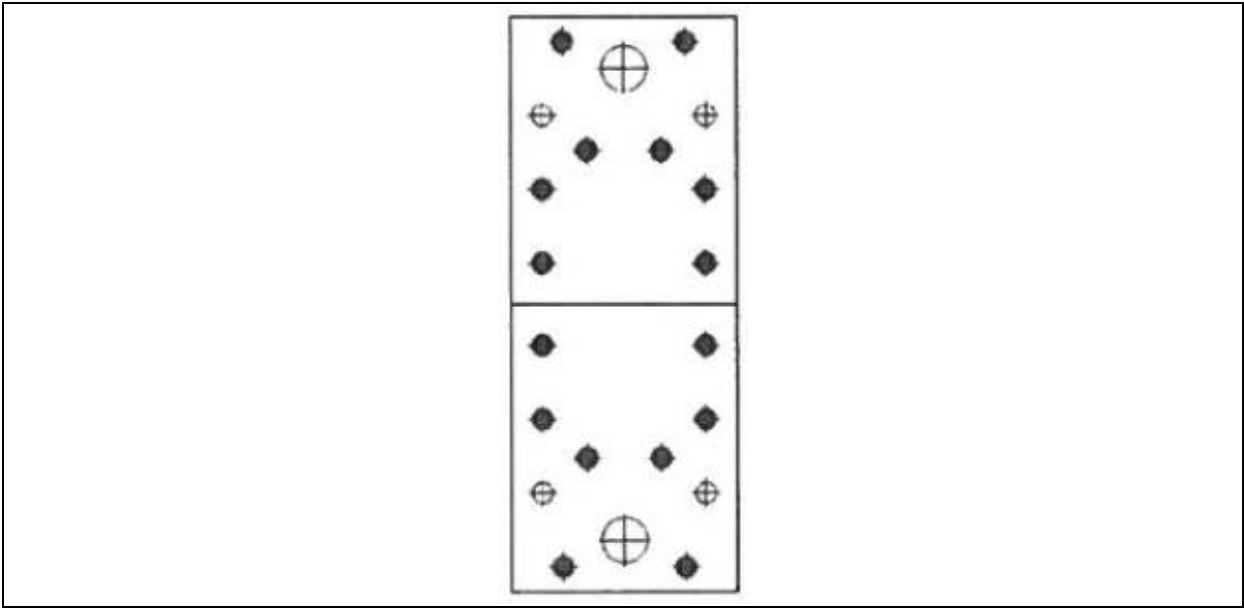


Figure 101 Type KL 2

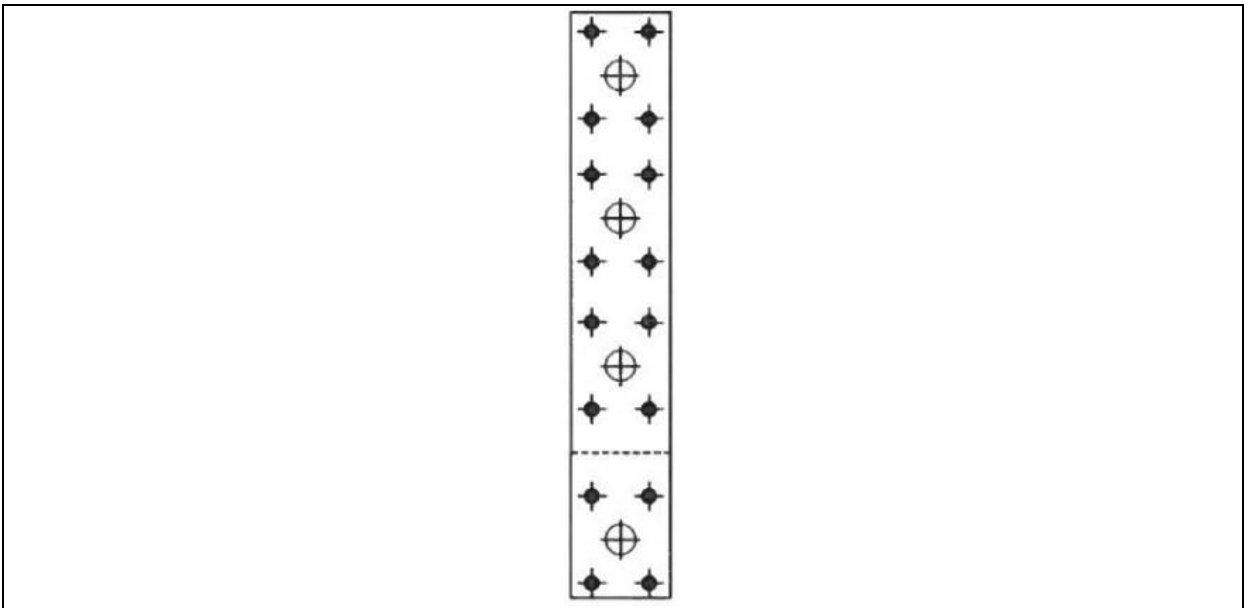


Figure 102 Type KL 3

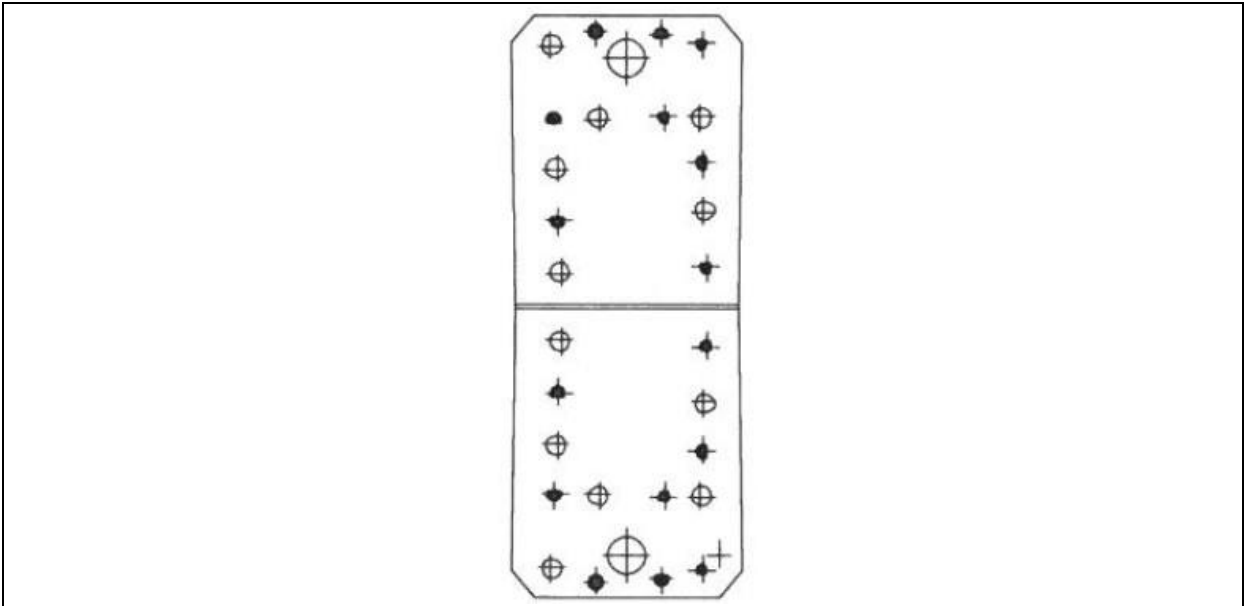


Figure 103 Type KL 4

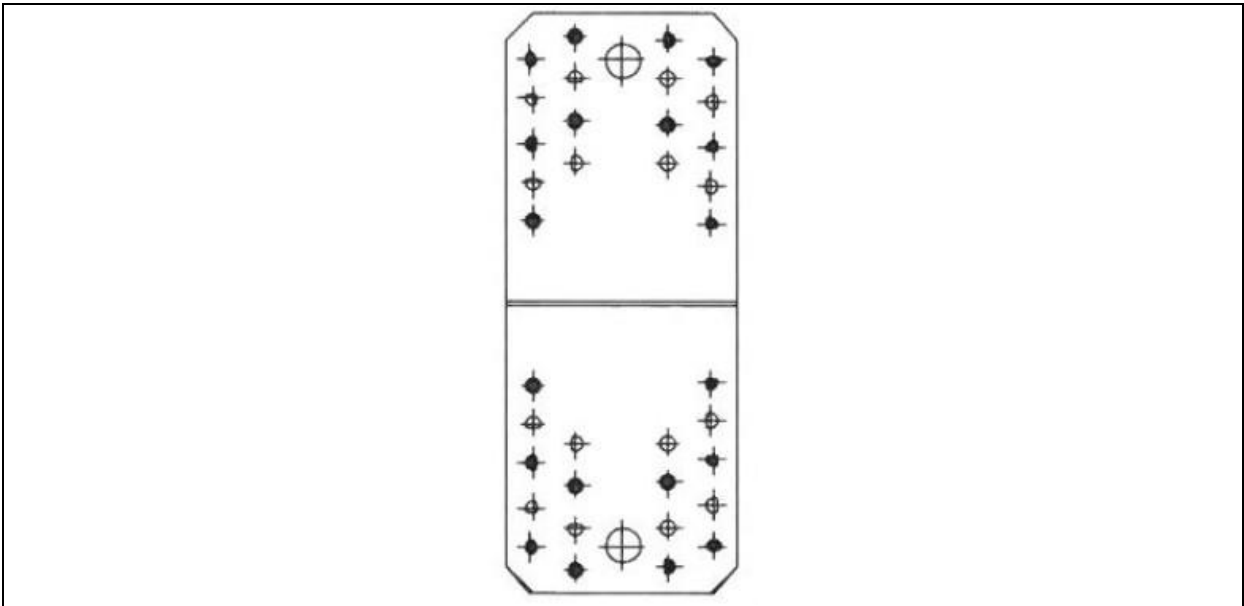


Figure 104 Type KL 5

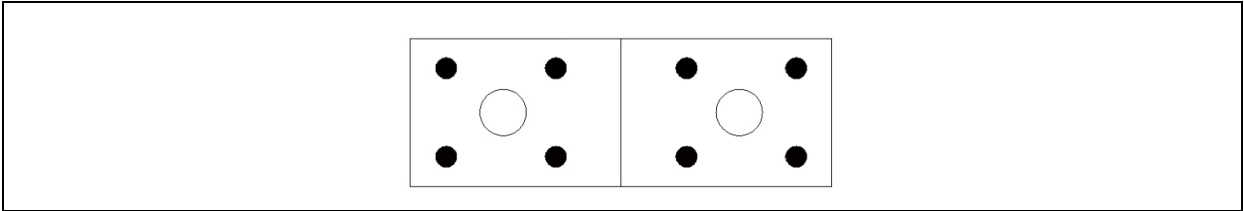


Figure 105 Type KL 101

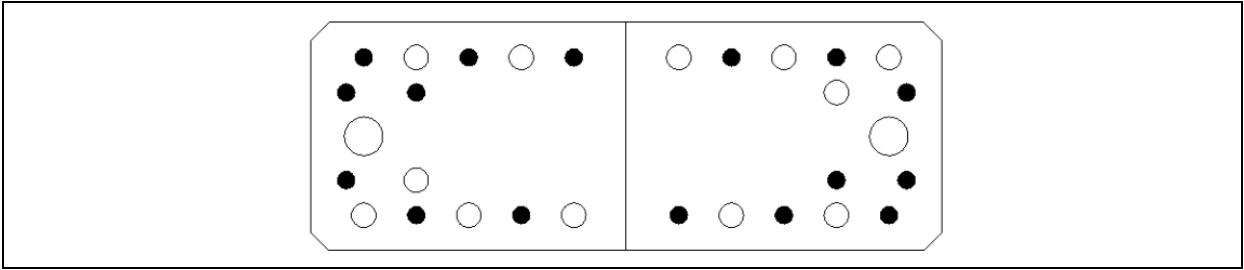


Figure 106 Type KL 104

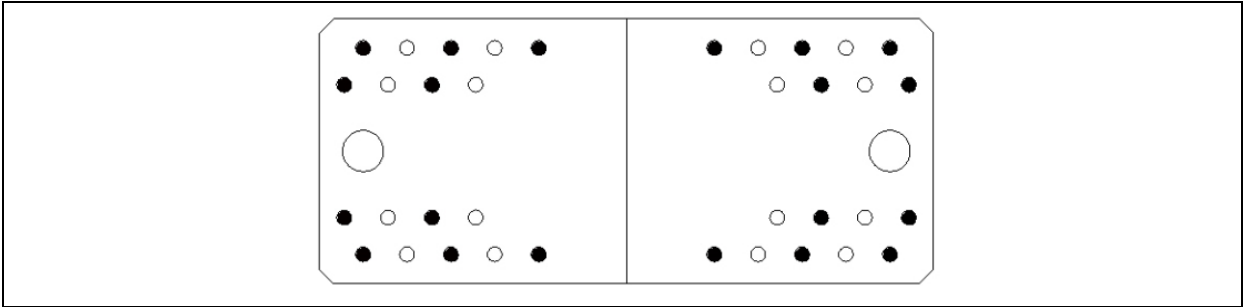


Figure 107 Type KL 105

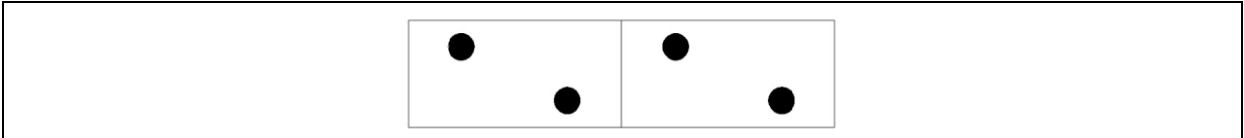


Figure 108 Type KM 0

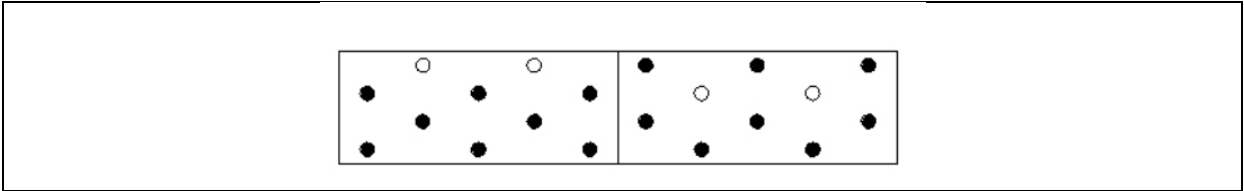


Figure 109 Type KM 21

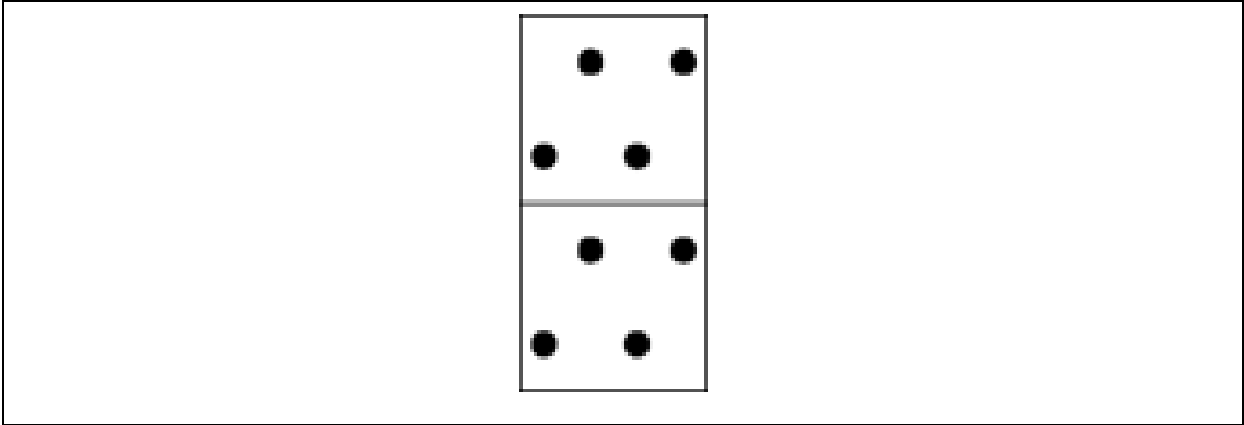


Figure 110 Type KM 1 (2.5 mm)

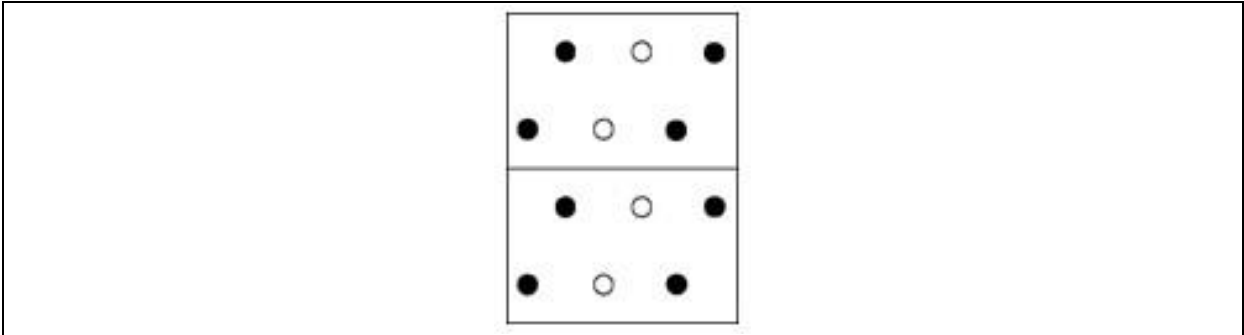


Figure 111 Type KM 2 (2.5 mm)

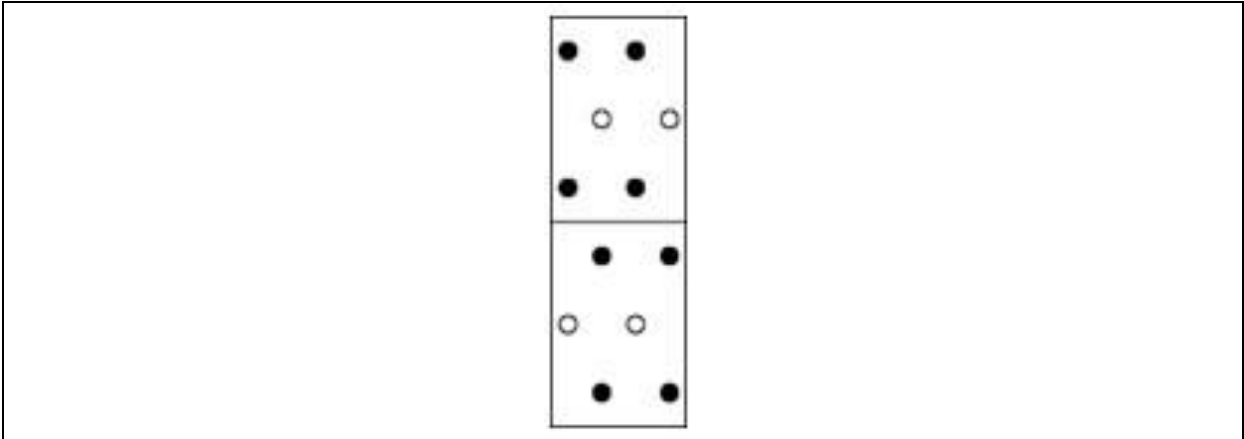


Figure 112 Type KM 3

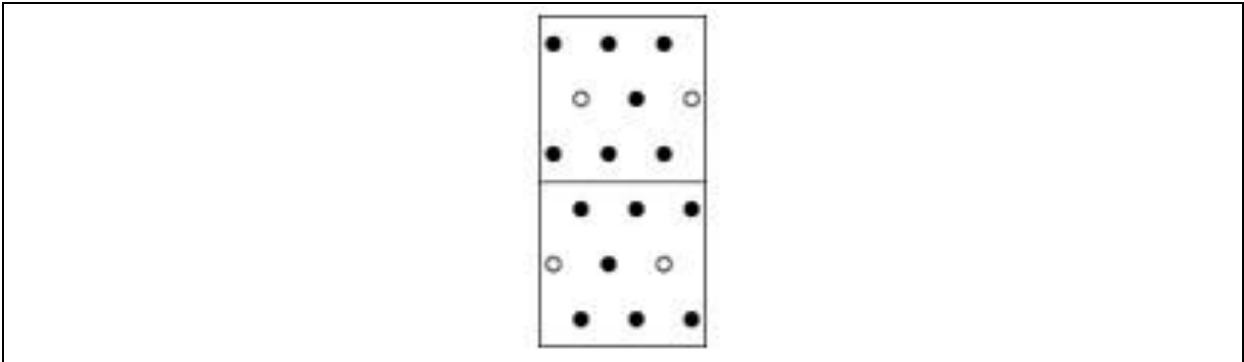


Figure 113 Type KM 4 (2.5 mm)

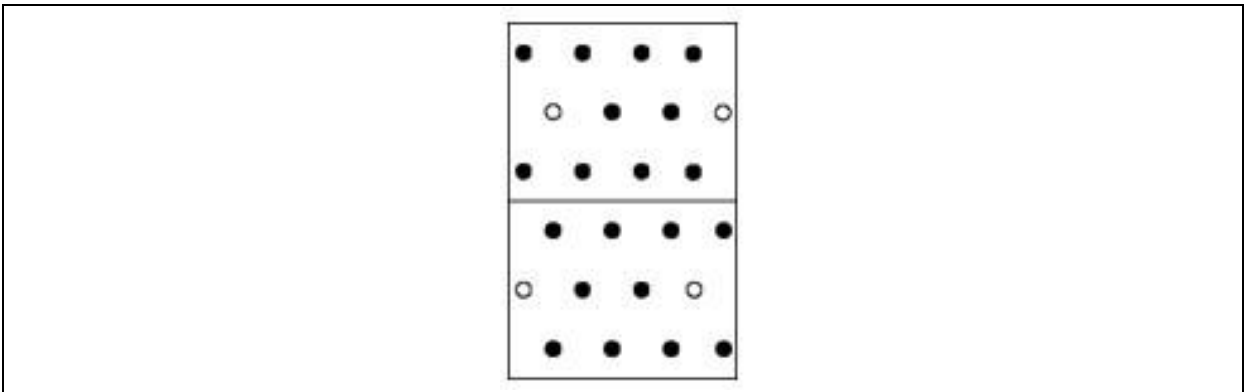


Figure 114 Type KM 5 (2.5 mm)

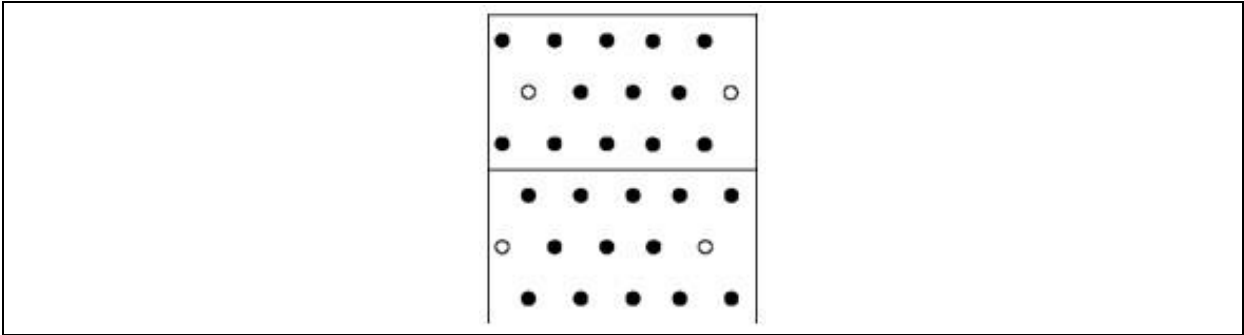


Figure 115 Type KM 6 (2.5 mm)

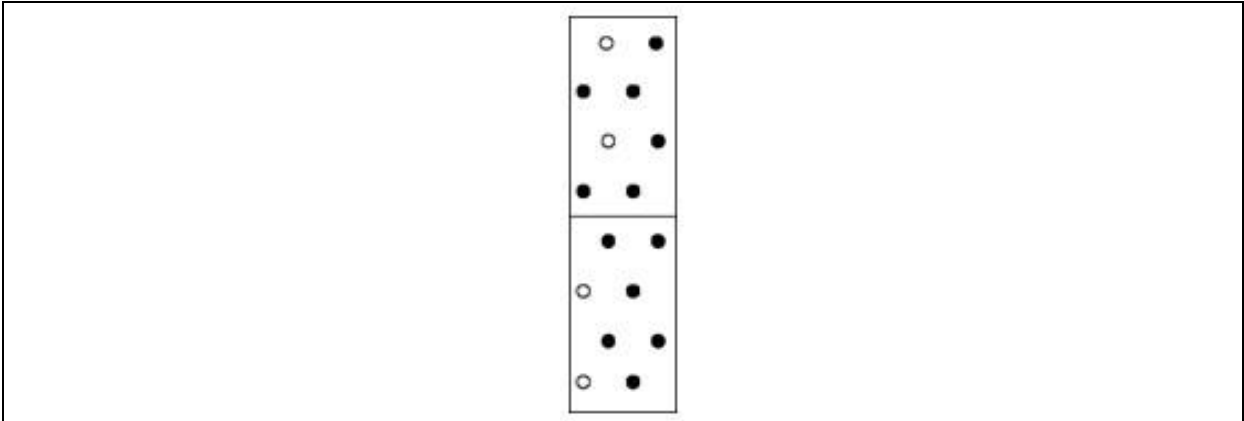


Figure 116 Type KM 7 (2.5 mm)

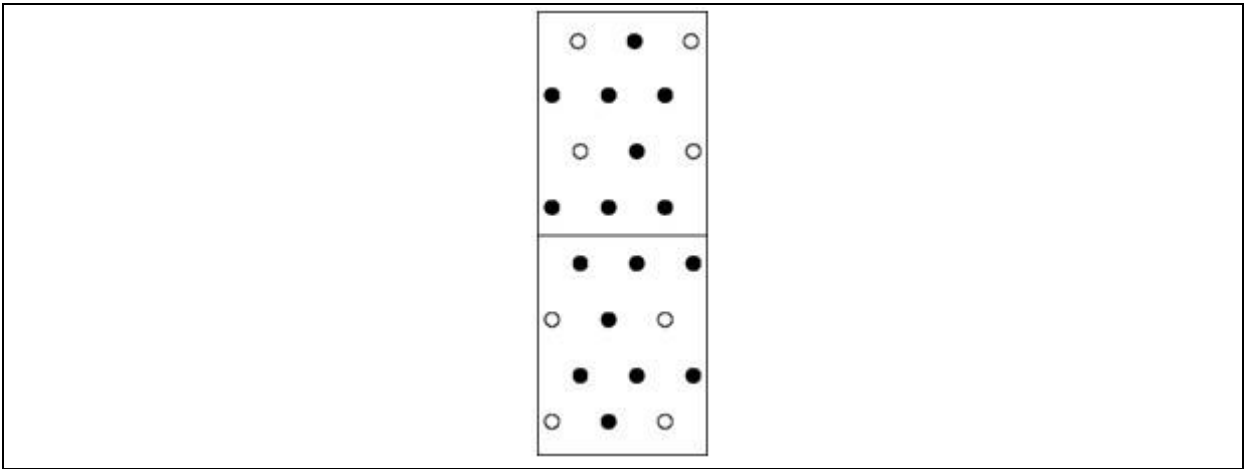


Figure 117 Type KM 8

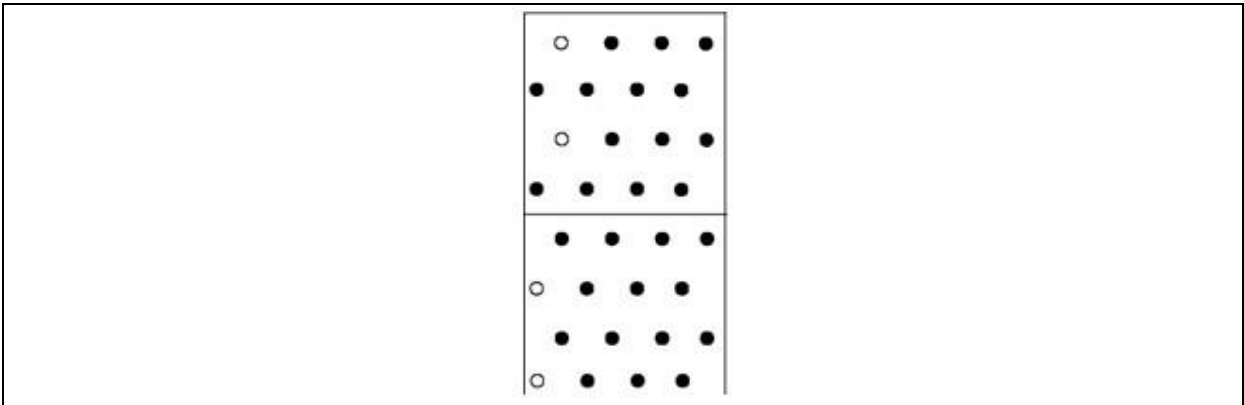
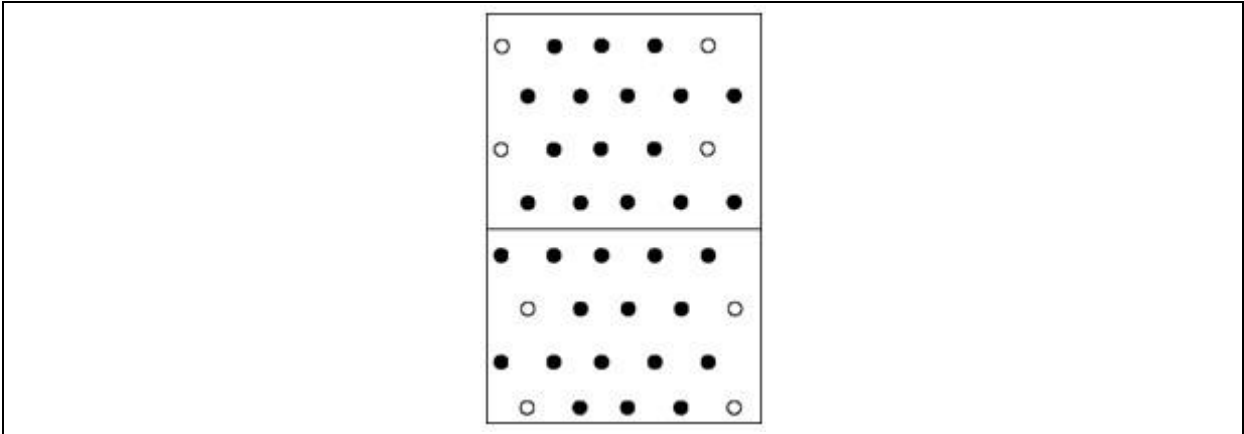
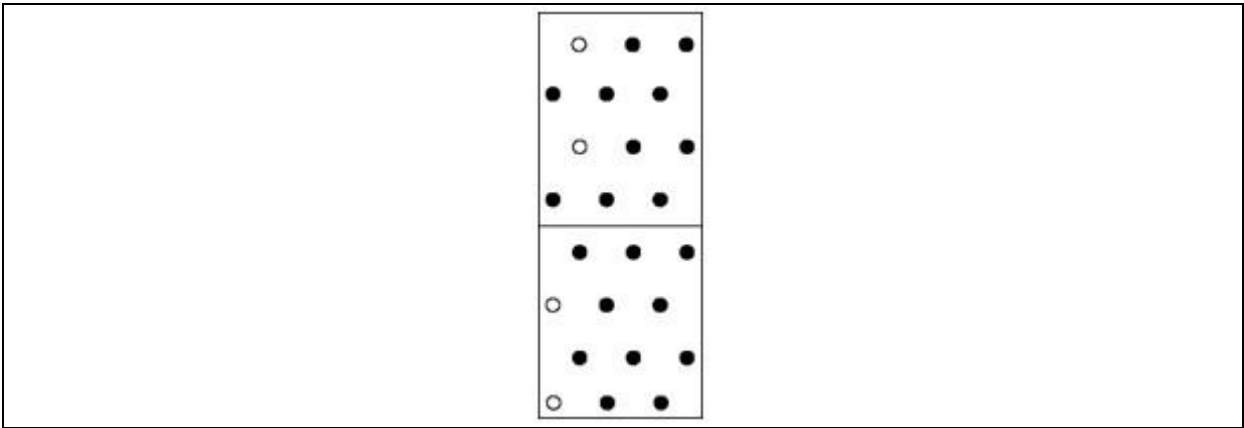


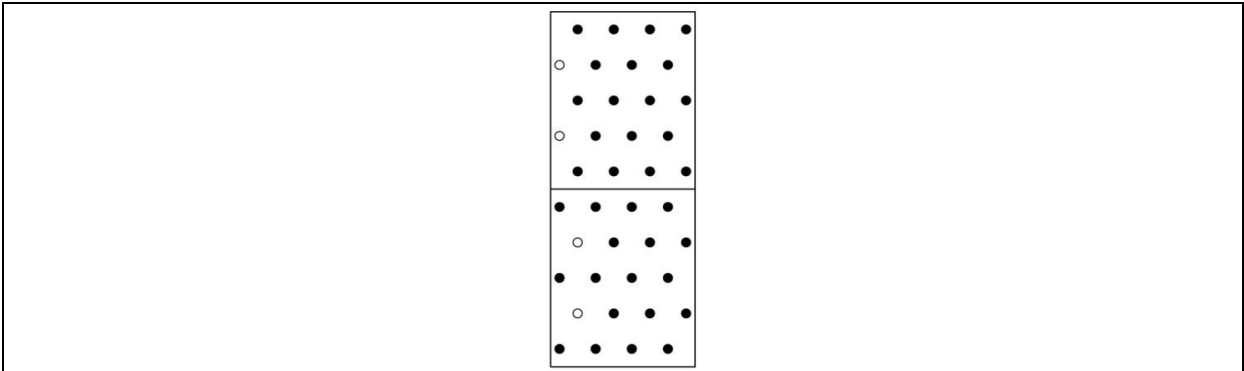
Figure 118 Type KM 9 (2.5 mm)



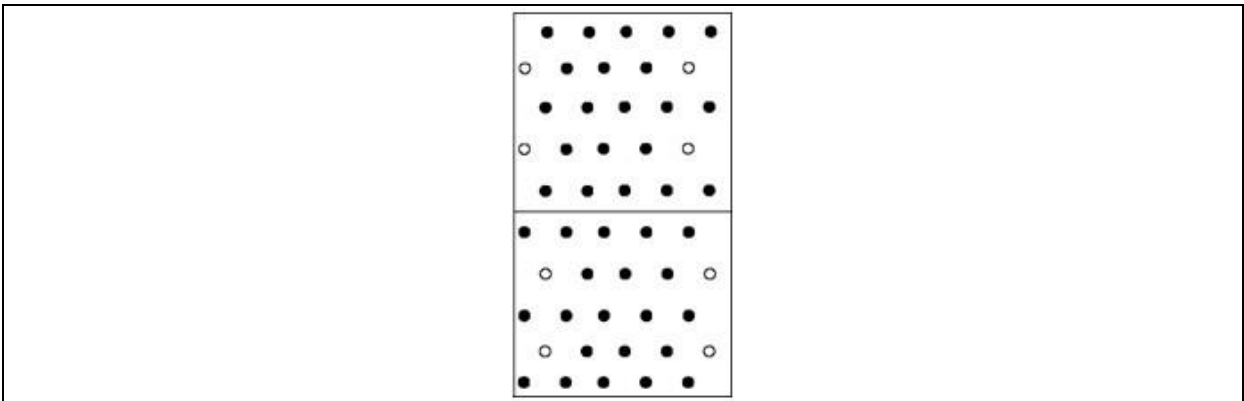
**Figure 119** Type KM 10 (2.5 mm)



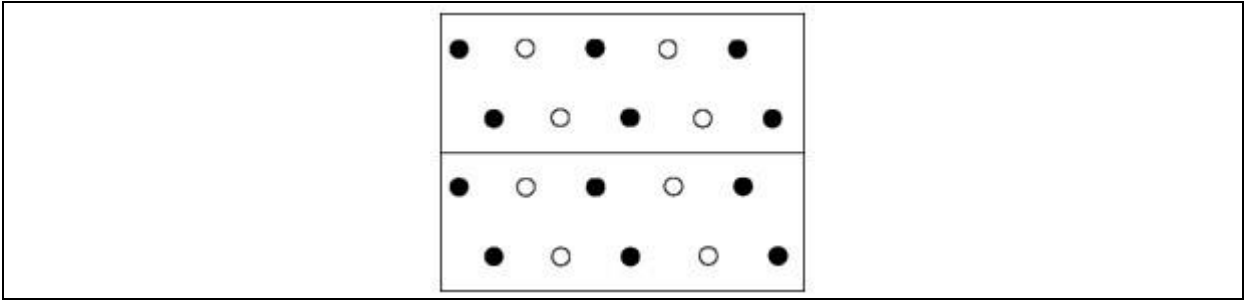
**Figure 120** Type KM 11 (2.5 mm)



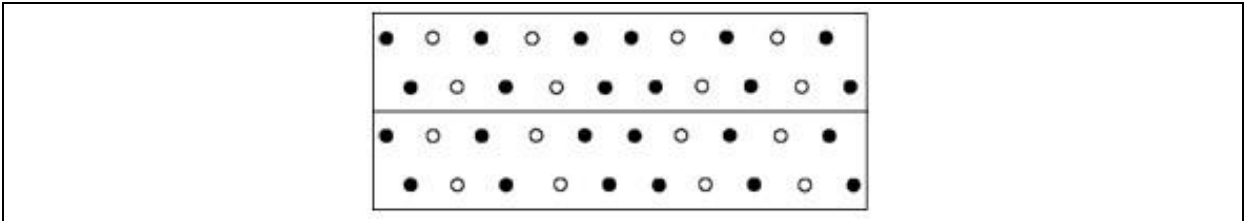
**Figure 121** Type KM 12 (2.5 mm)



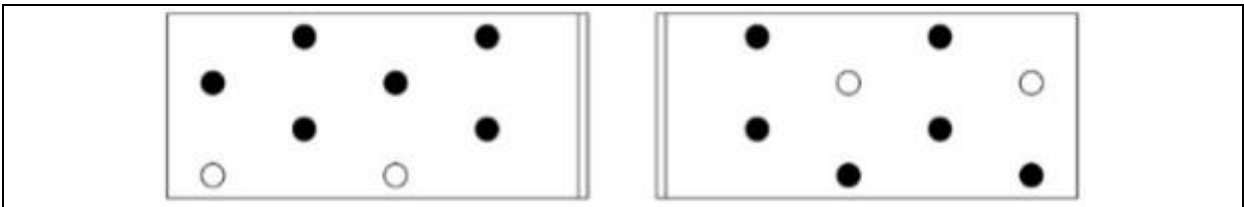
**Figure 122** Type KM 13 (2.5 mm)



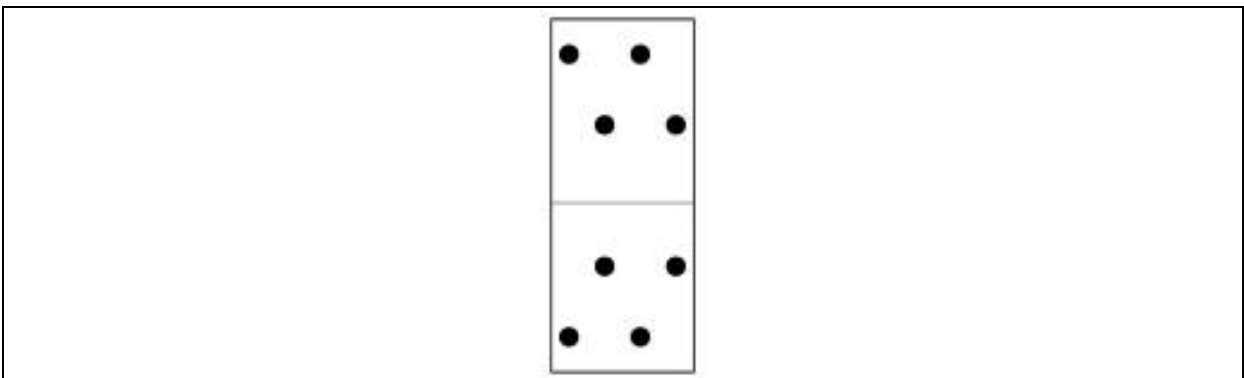
**Figure 123** Type KM 14 (2.5 mm)



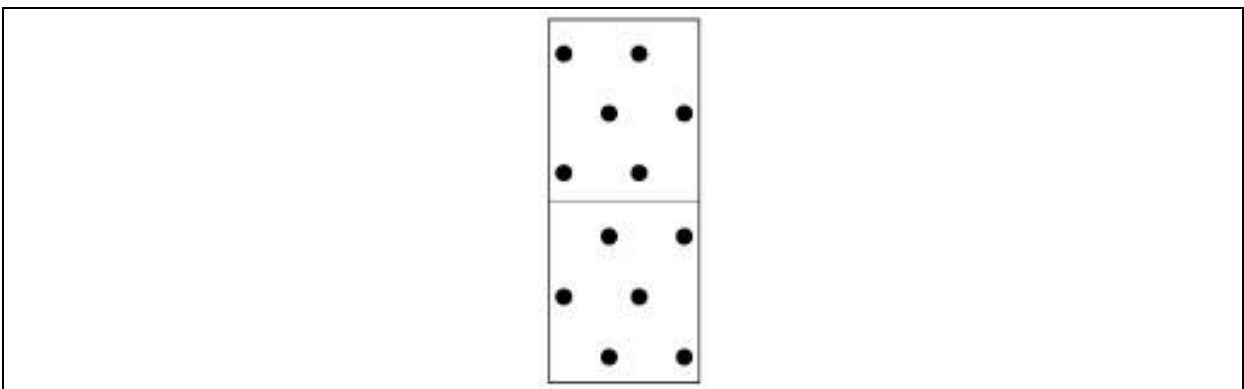
**Figure 124** Type KM 15 (2.5 mm)



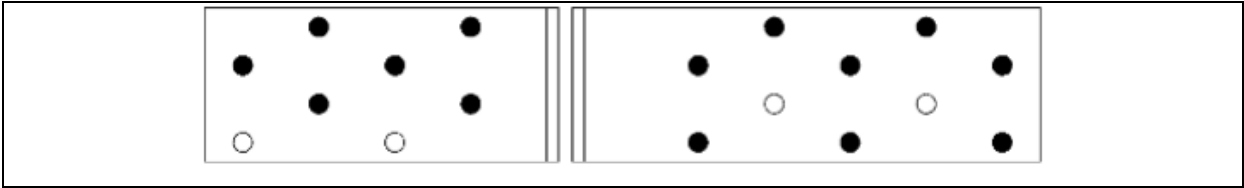
**Figure 125** Type KM 16 (2.5 mm)



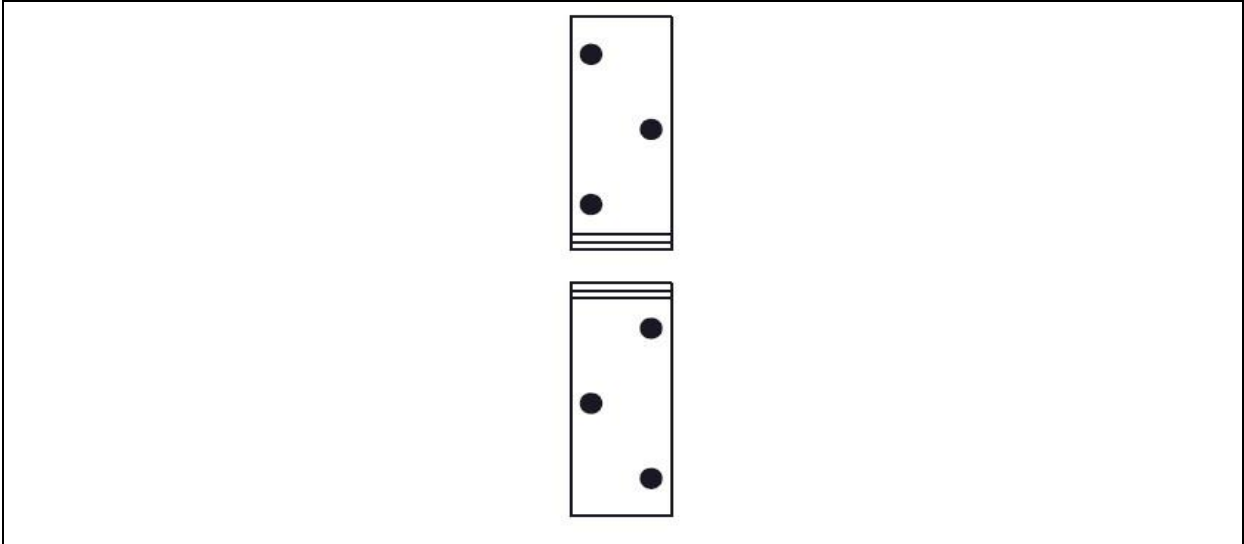
**Figure 126** Type KM 17 (2.5 mm)



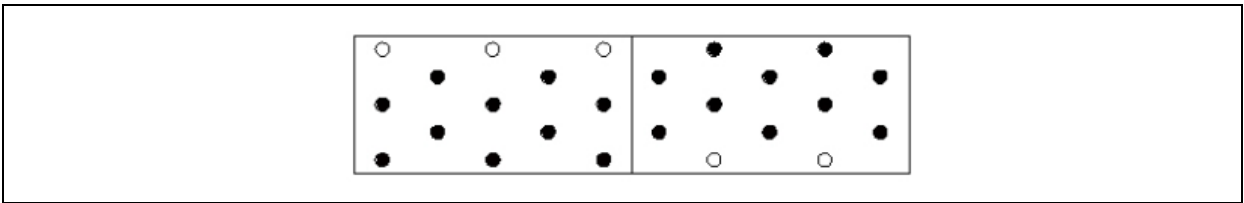
**Figure 127** Type KM 18 (2.5 mm)



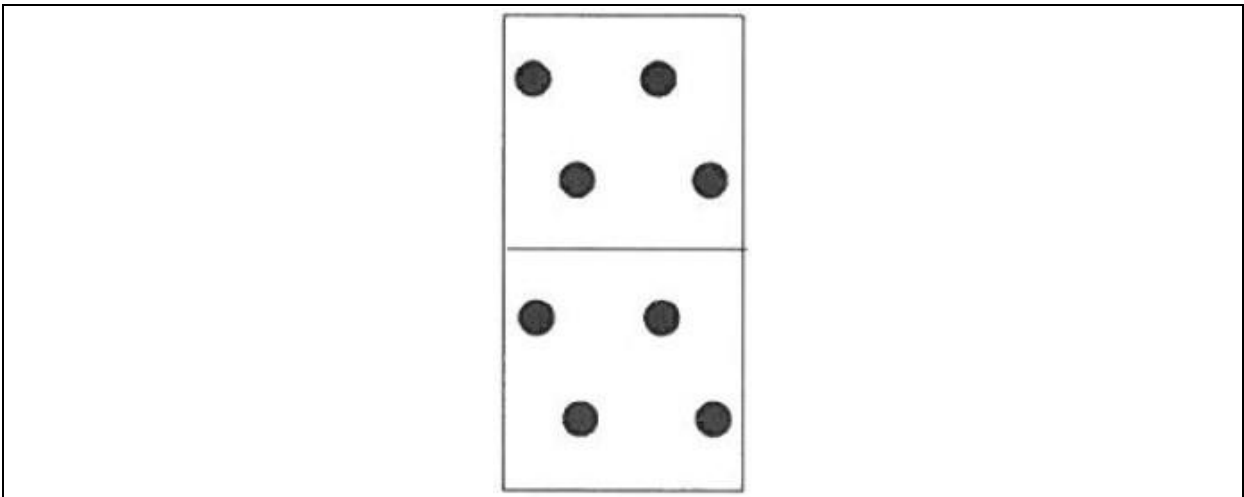
**Figure 128** Type KM 19 (2.5 mm)



**Figure 129** Type KM 20 (2.5 mm)



**Figure 130** Type KM 22 (2.5 mm)



**Figure 131** Type KMP 1



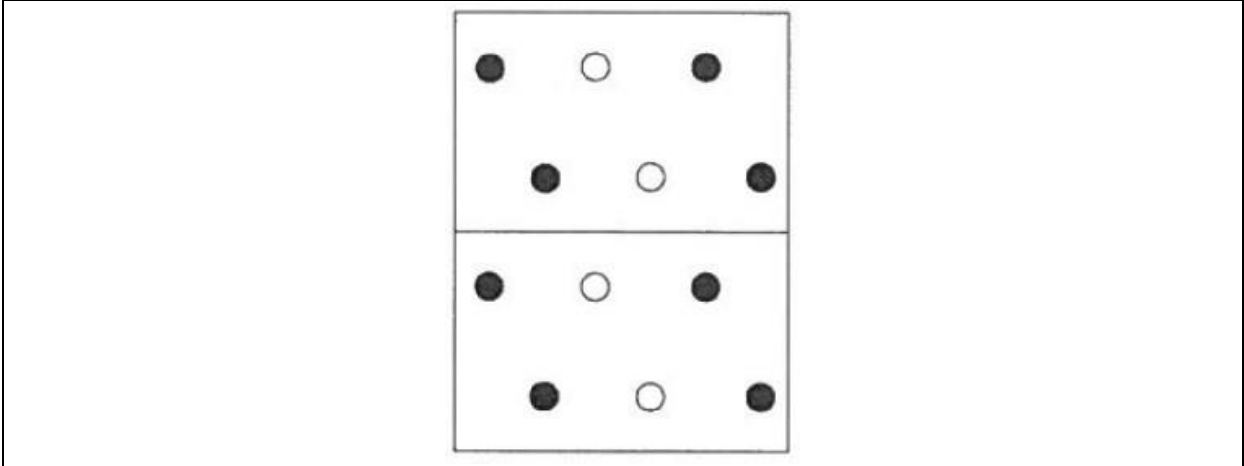


Figure 132 Type KMP 2

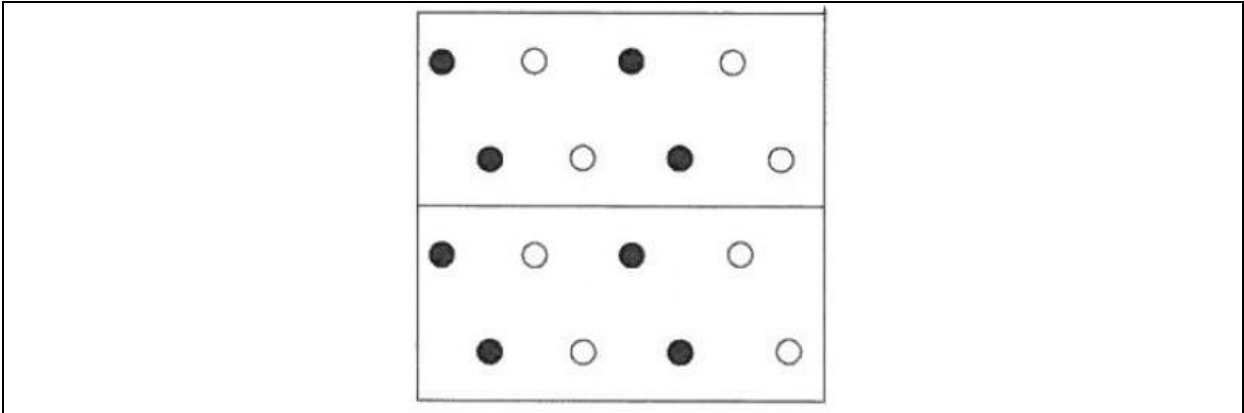


Figure 133 Type KMP 3

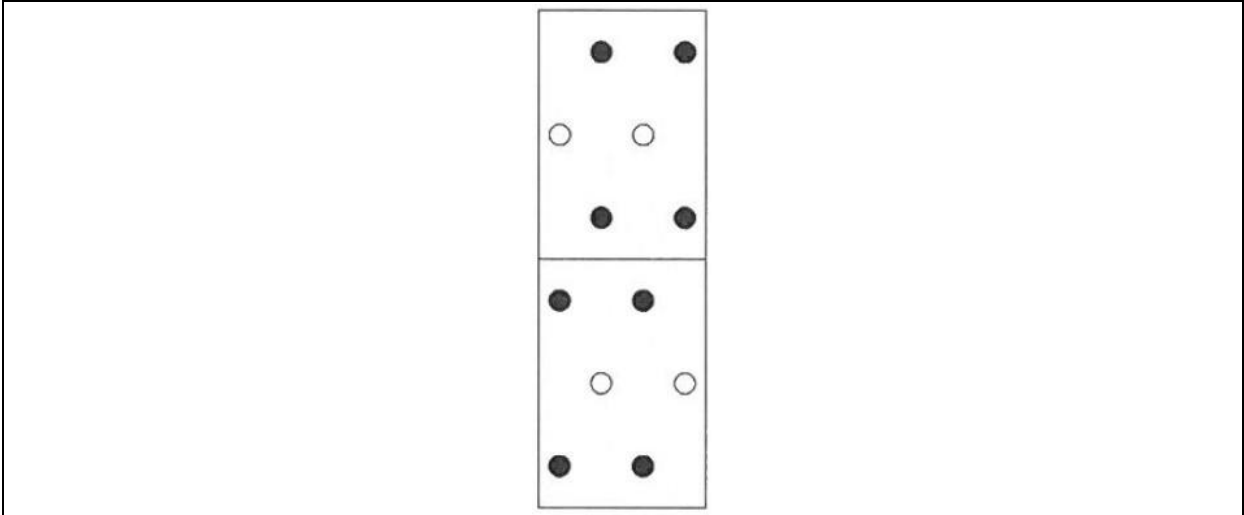


Figure 134 Type KMP 4

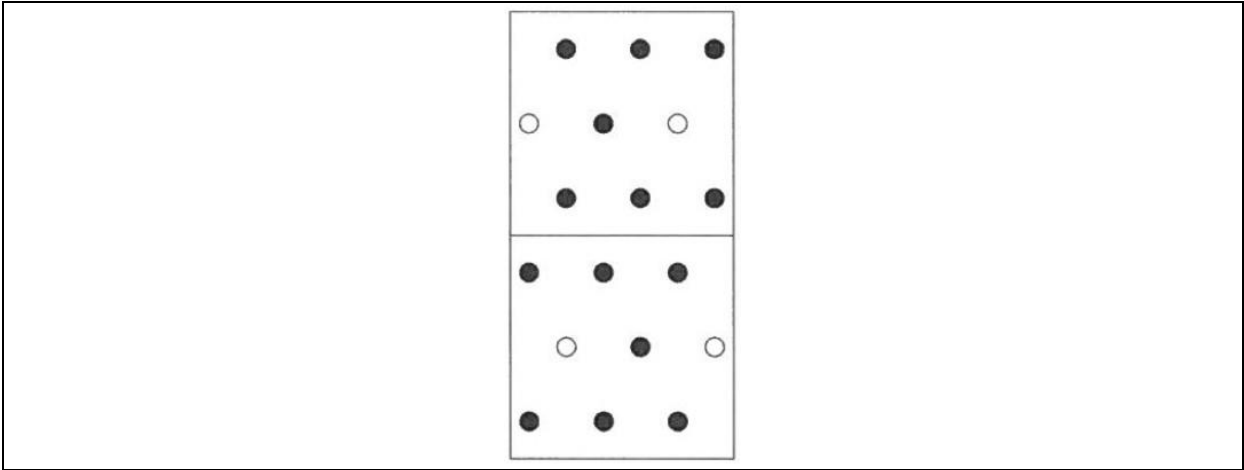


Figure 135 Type KMP 5

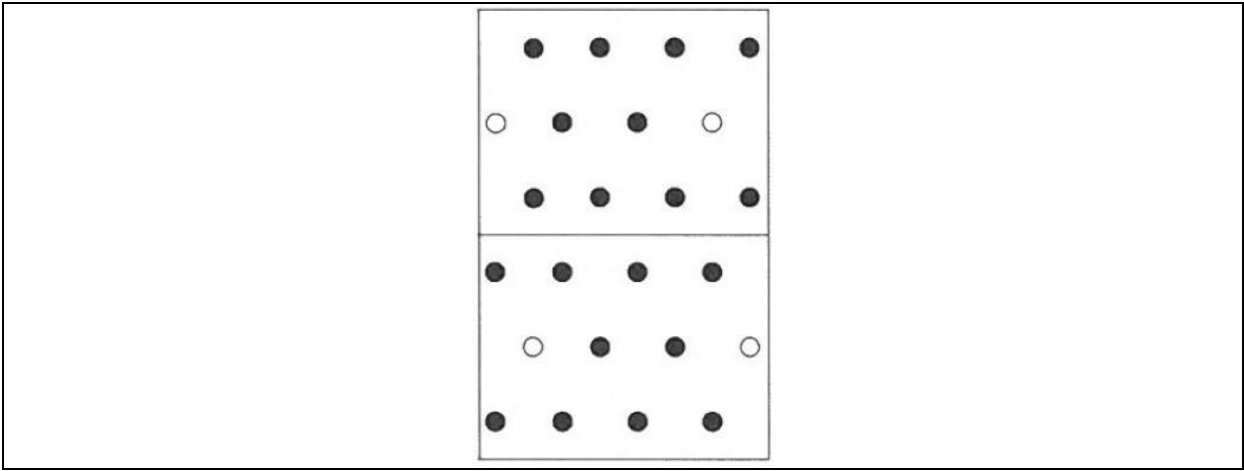


Figure 136 Type KMP 6

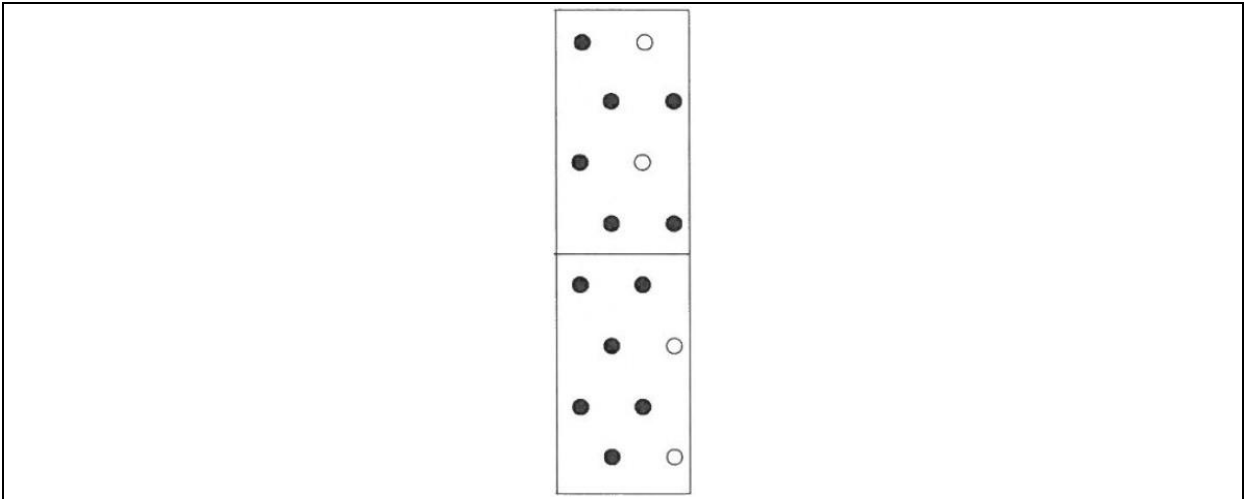


Figure 137 Type KMP 7

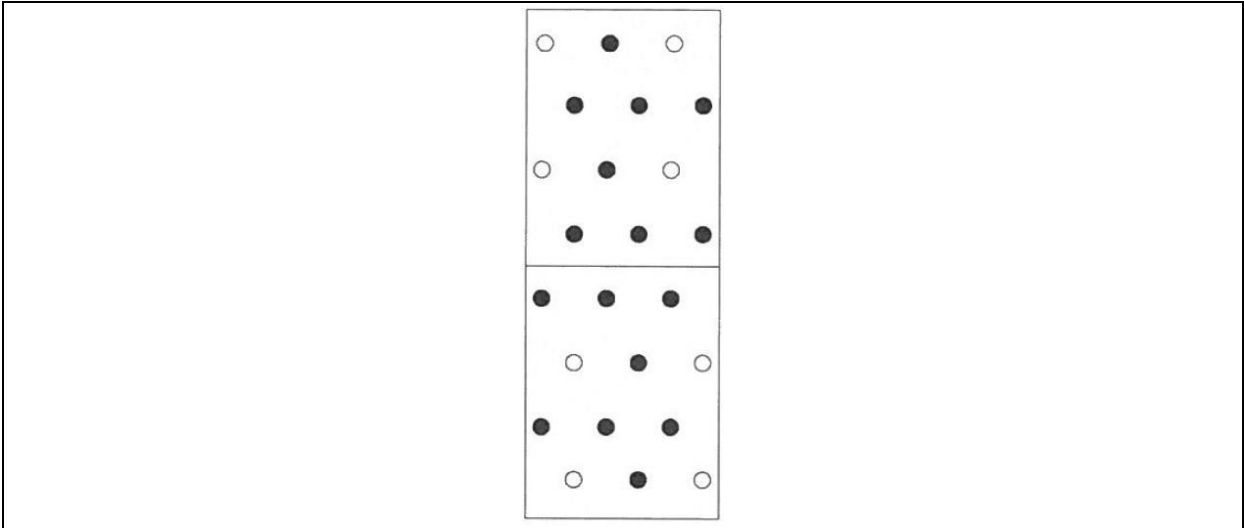


Figure 138 Type KMP 8

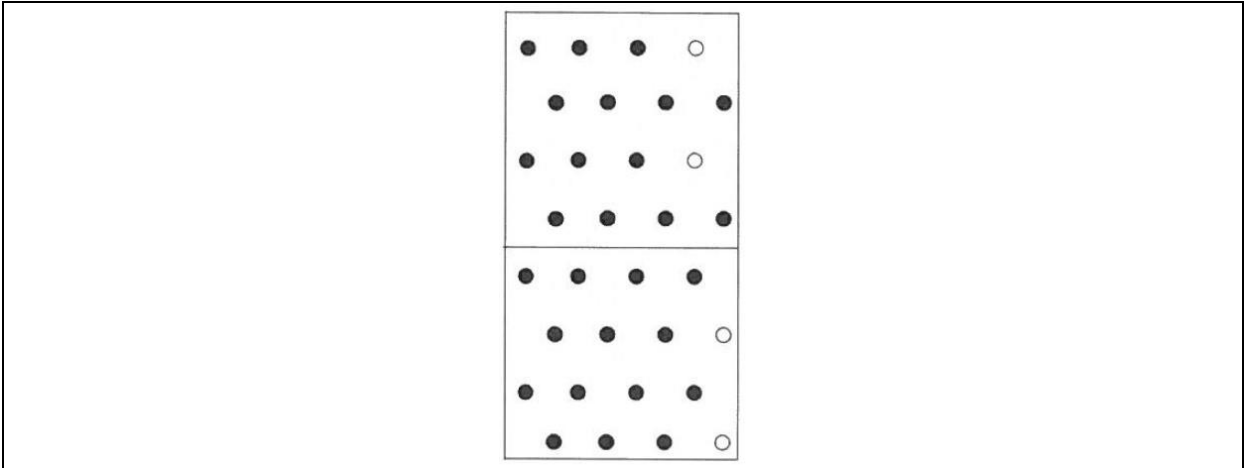


Figure 139 Type KMP 9

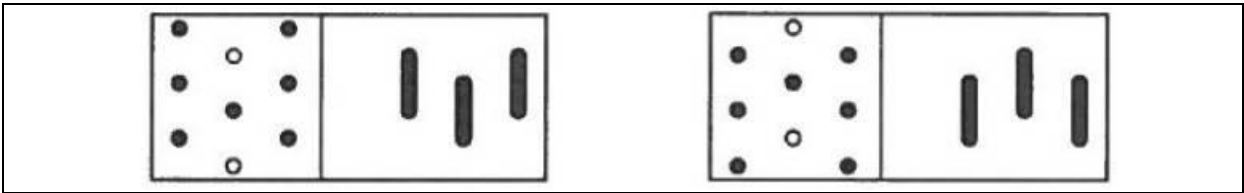


Figure 140 Type KMR 1 and KMR 2

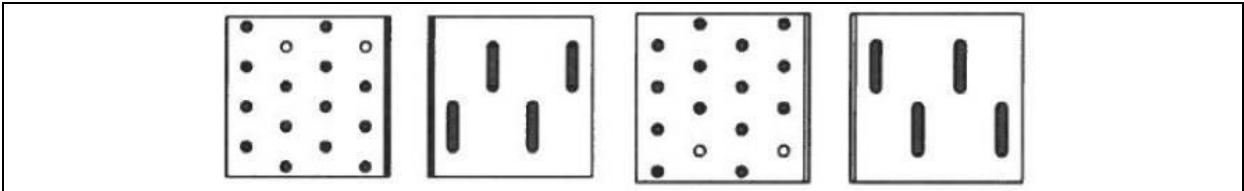


Figure 141 Type KMR 3 and KMR 4

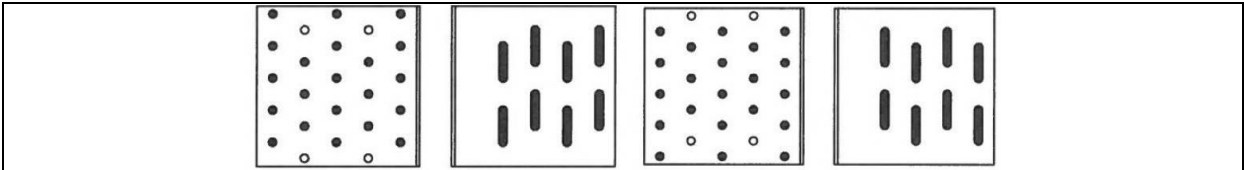
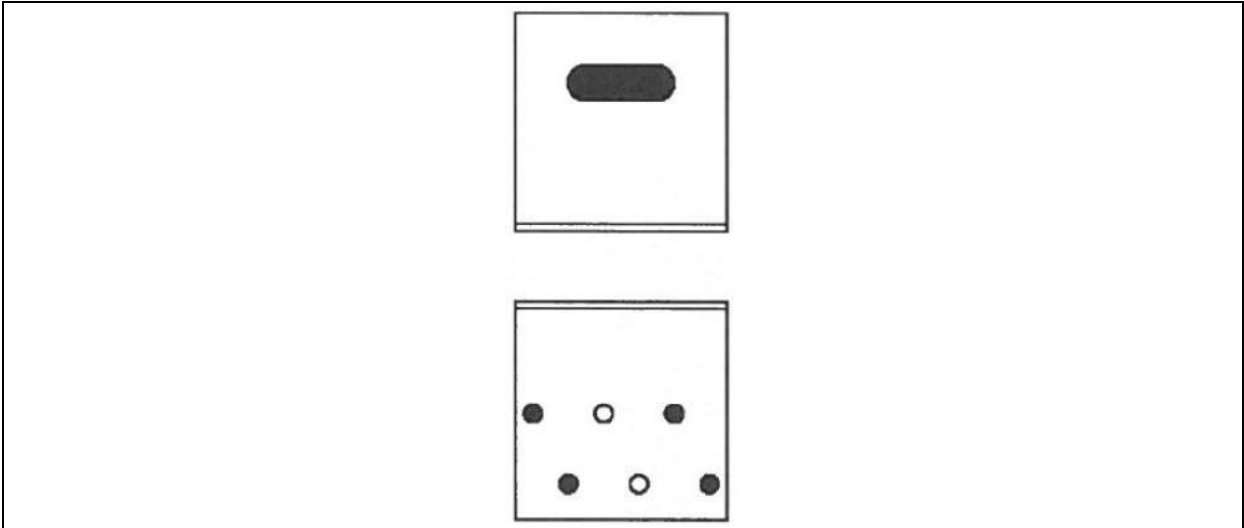
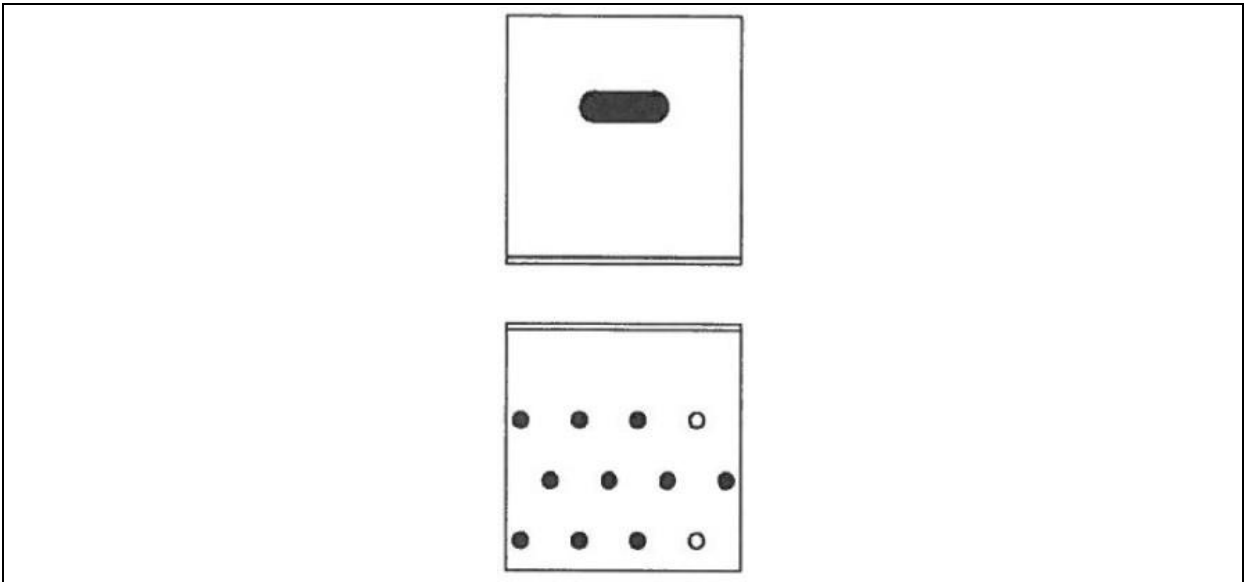


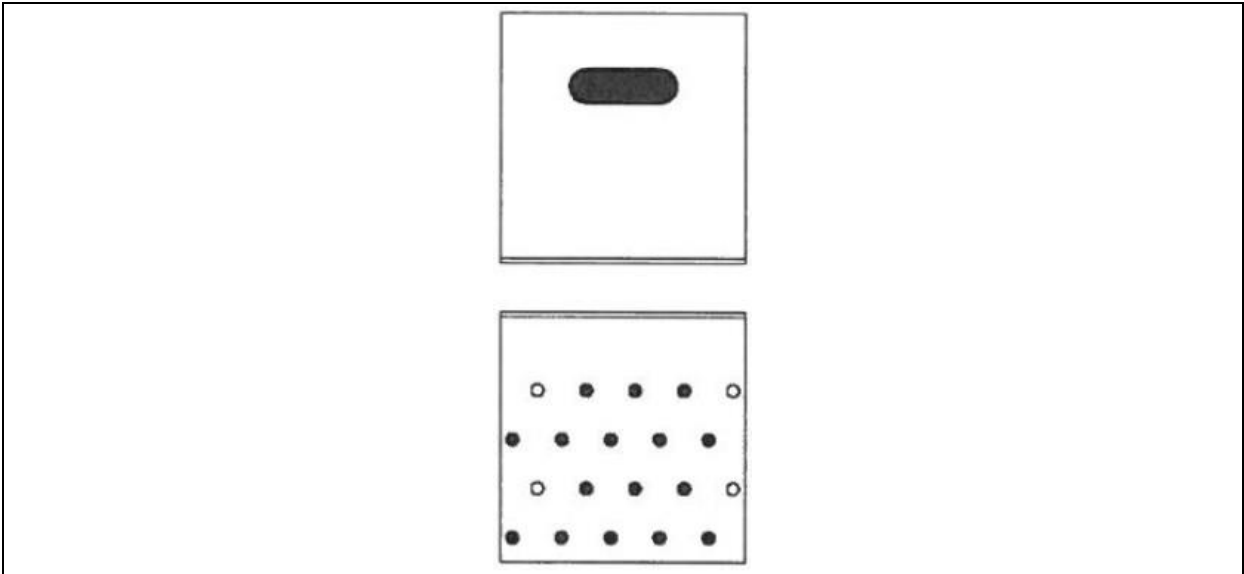
Figure 142 Type KMR 5 and KMR 6



**Figure 143** Type KMR 7



**Figure 144** Type KMR 8



**Figure 145** Type KMR 9

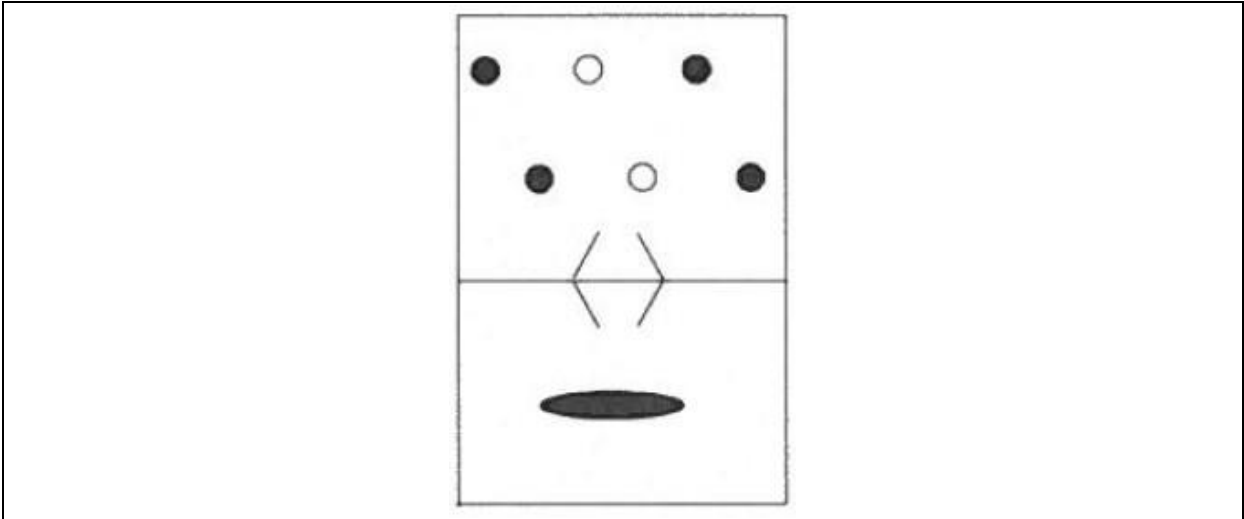


Figure 146 Type KMRP 1

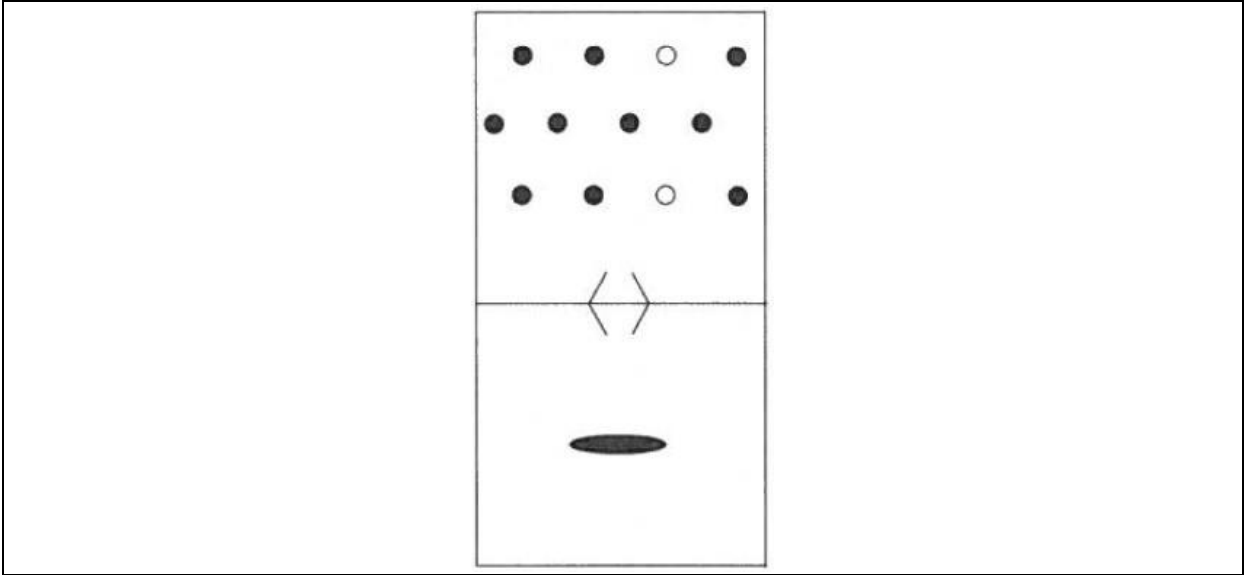


Figure 147 Type KMRP 2

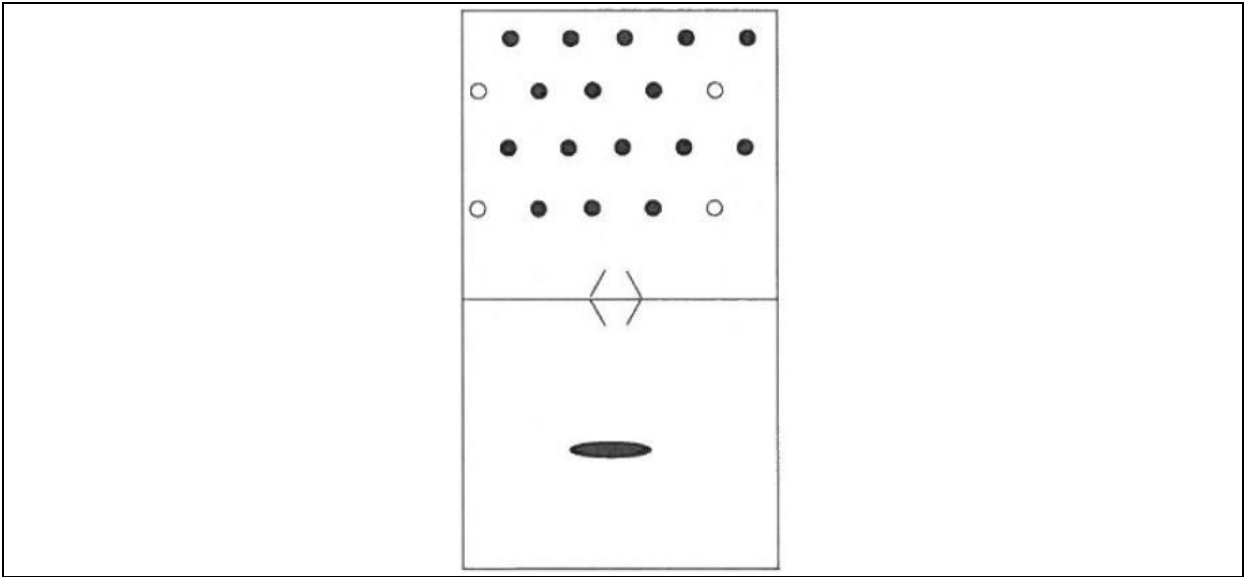
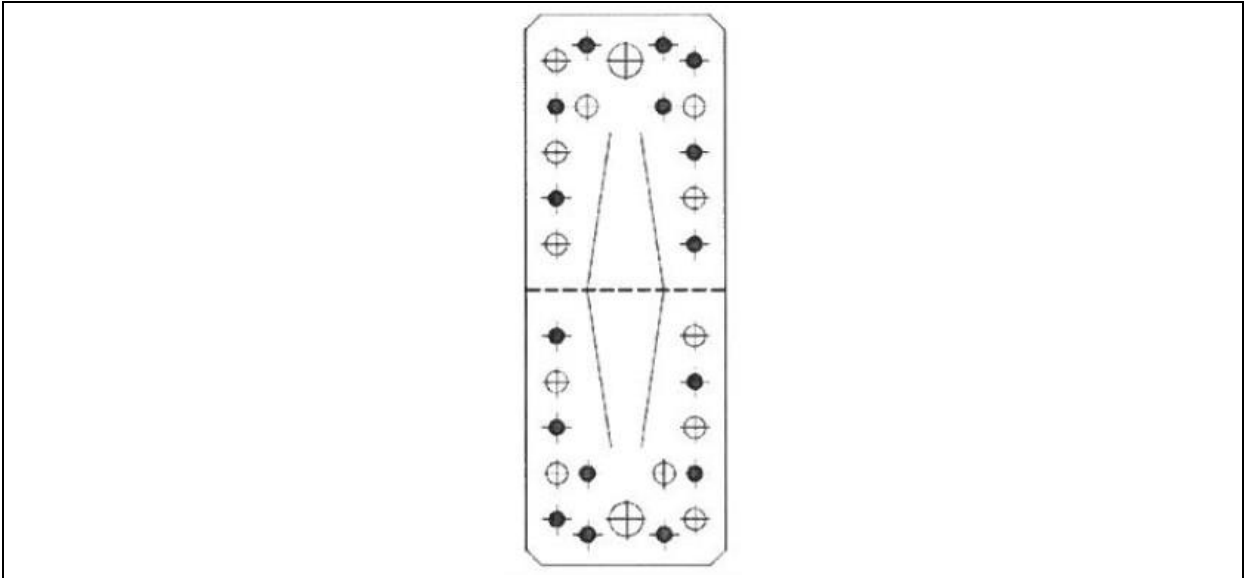
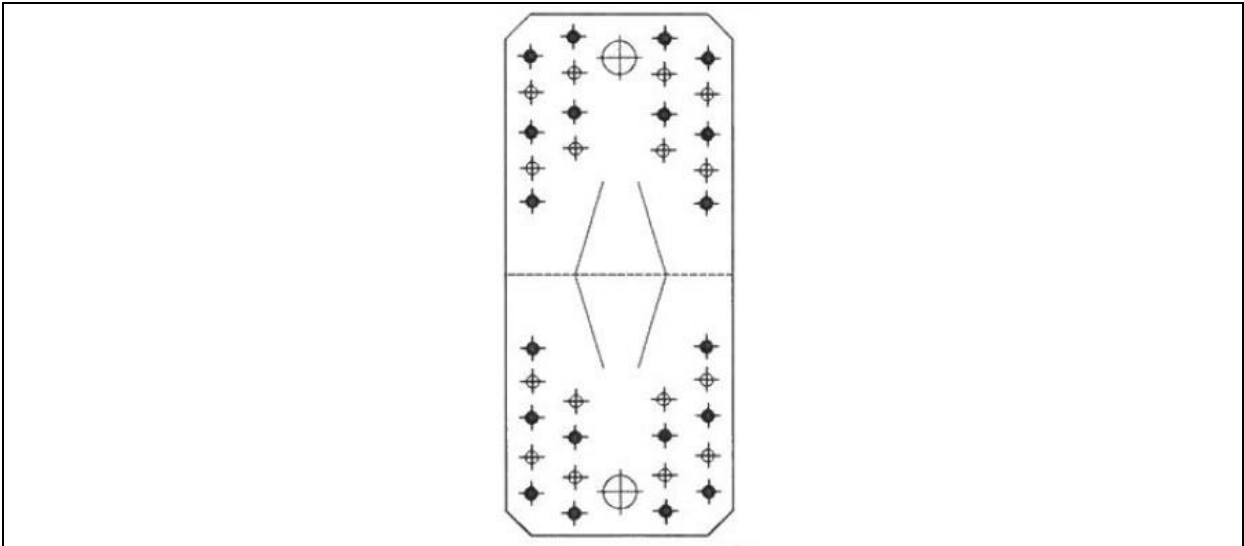


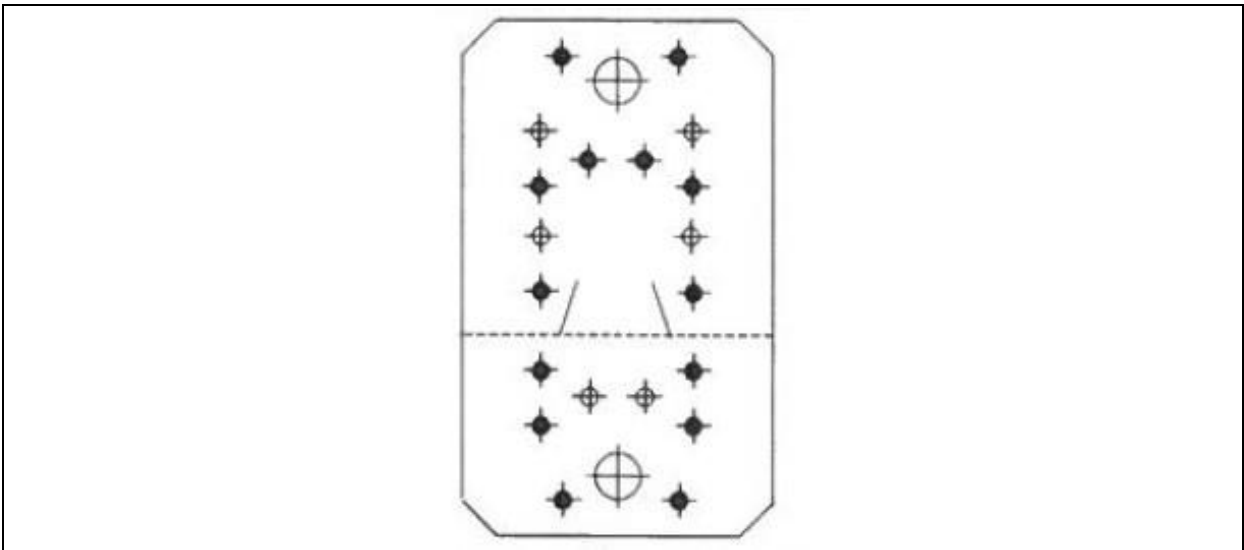
Figure 148 Type KMRP 3



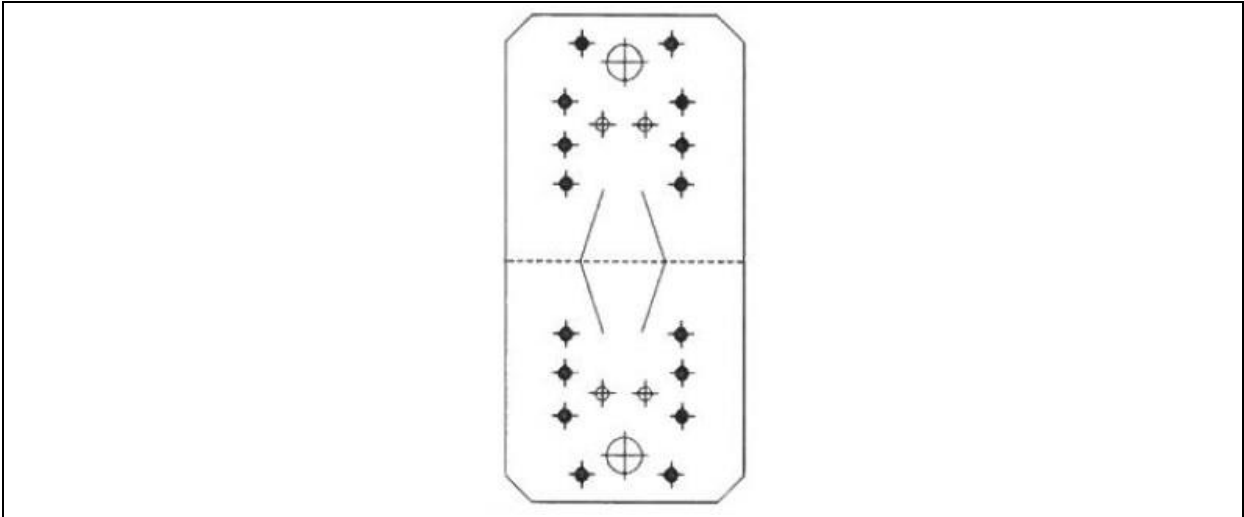
**Figure 149** Type KP 1 and KPL 1



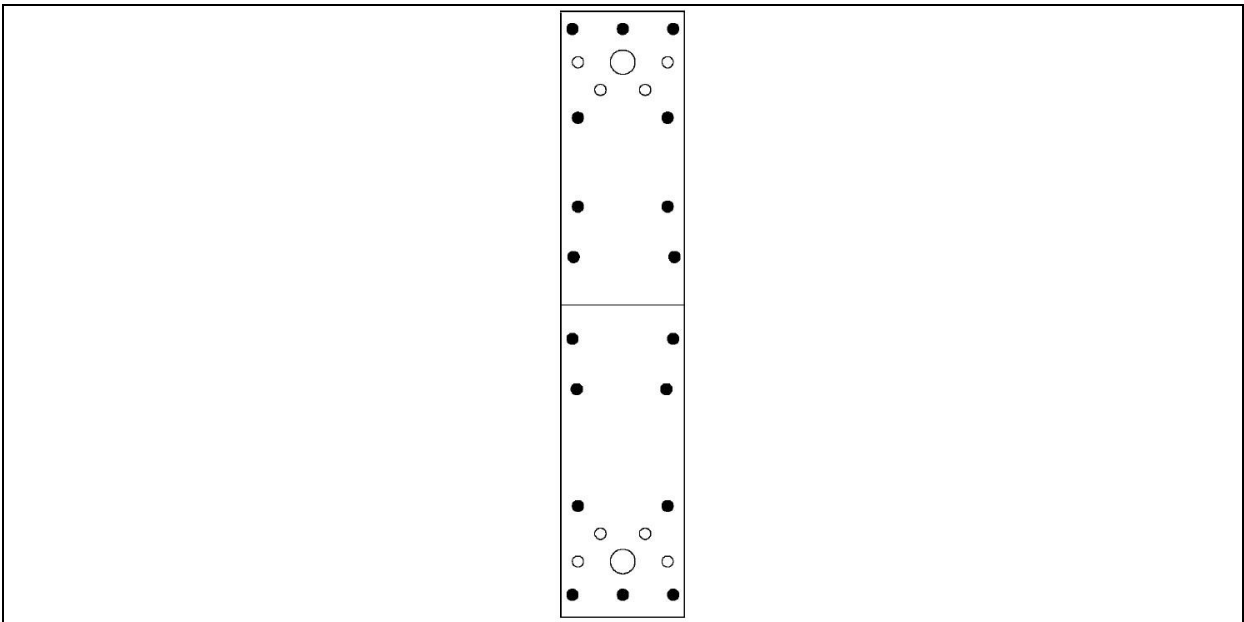
**Figure 150** Type KP 2 and KPL 2



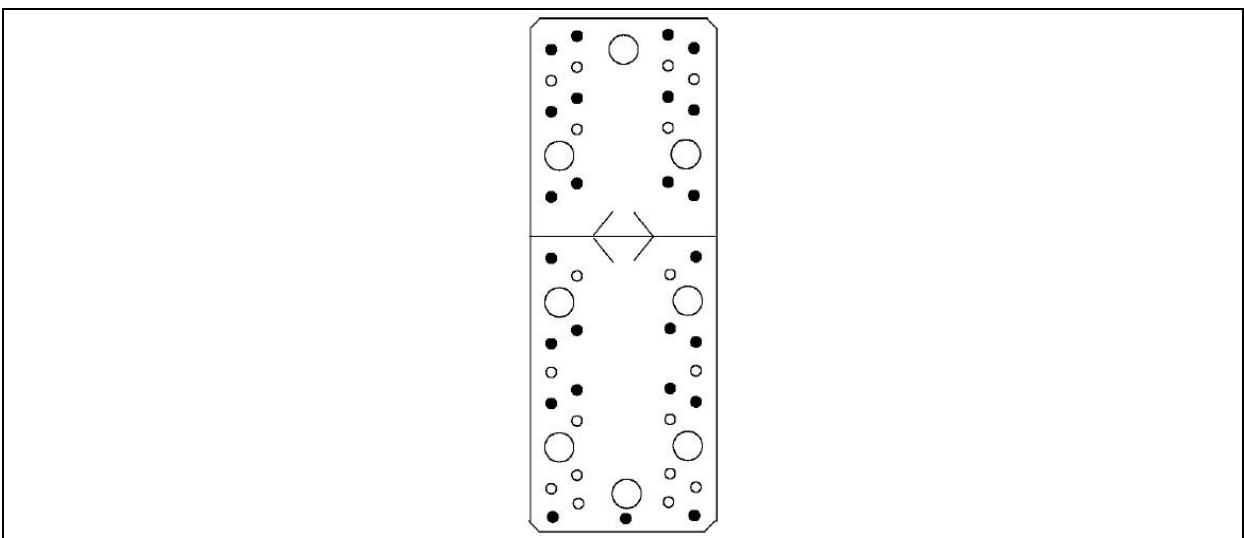
**Figure 151** Type KP 3 and KPL 3



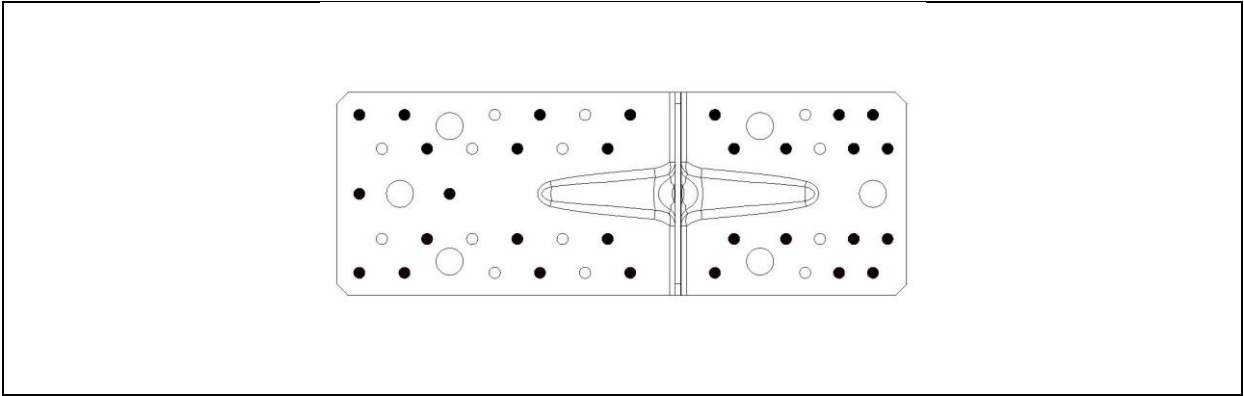
**Figure 152** Type KP 4 and KPL 4



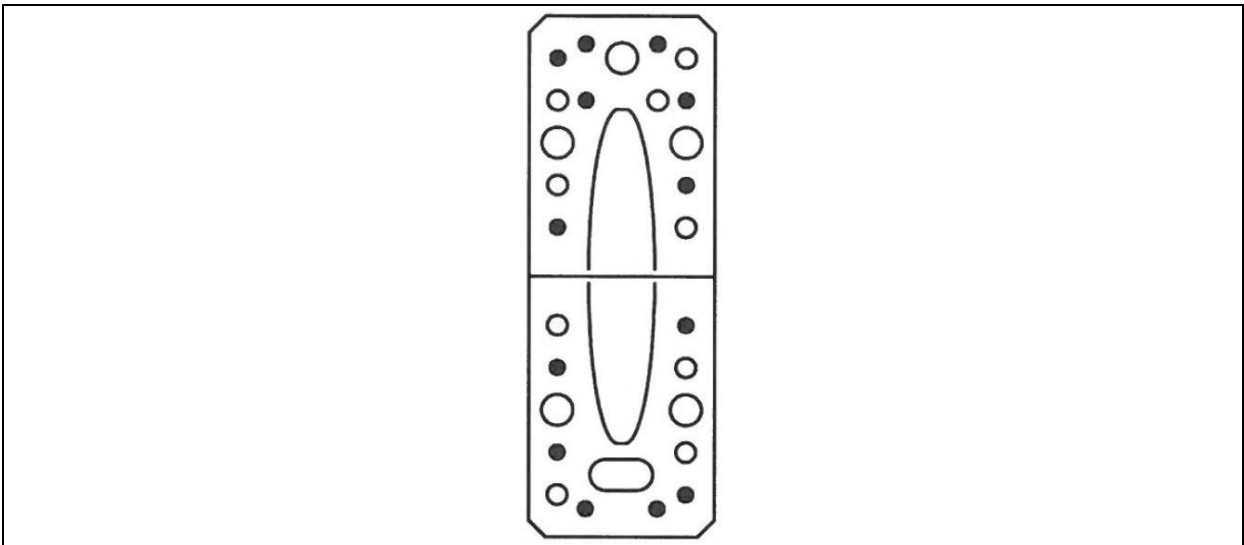
**Figure 153** Type KP 5



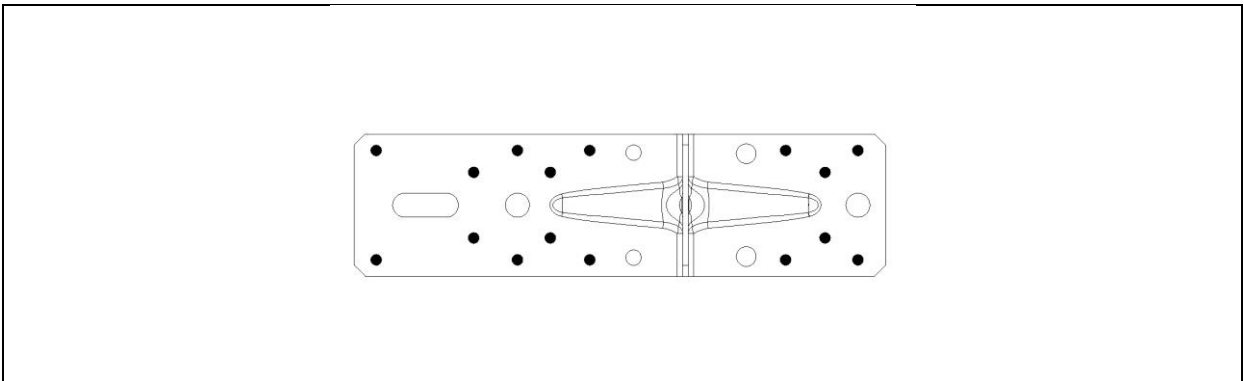
**Figure 154** Type KP 6



**Figure 155** Type KP 10 and KPL 10

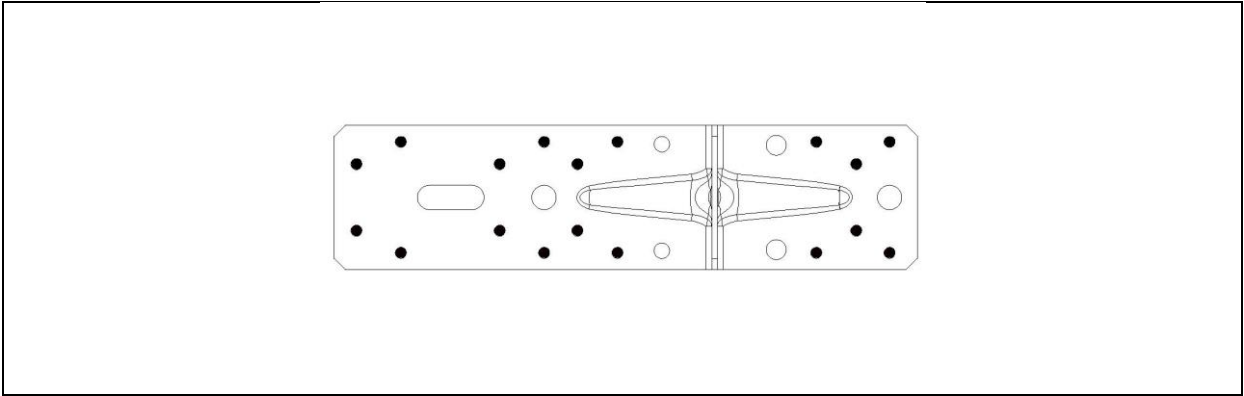


**Figure 156** Type KP 11

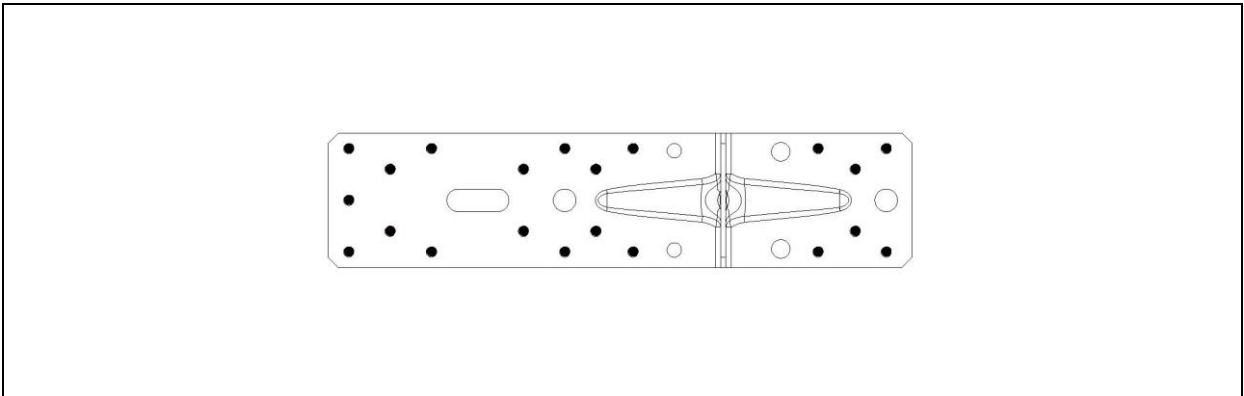


**Figure 157** Type KP 12 and KPL 12

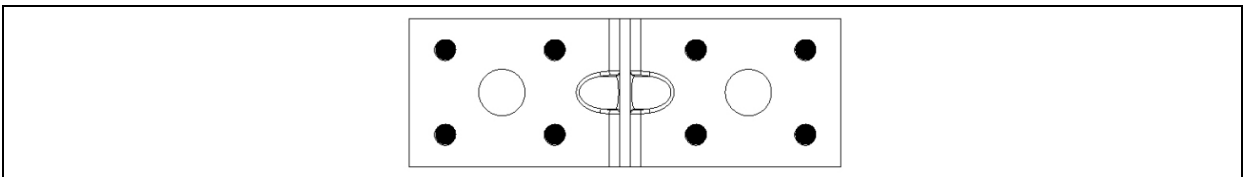




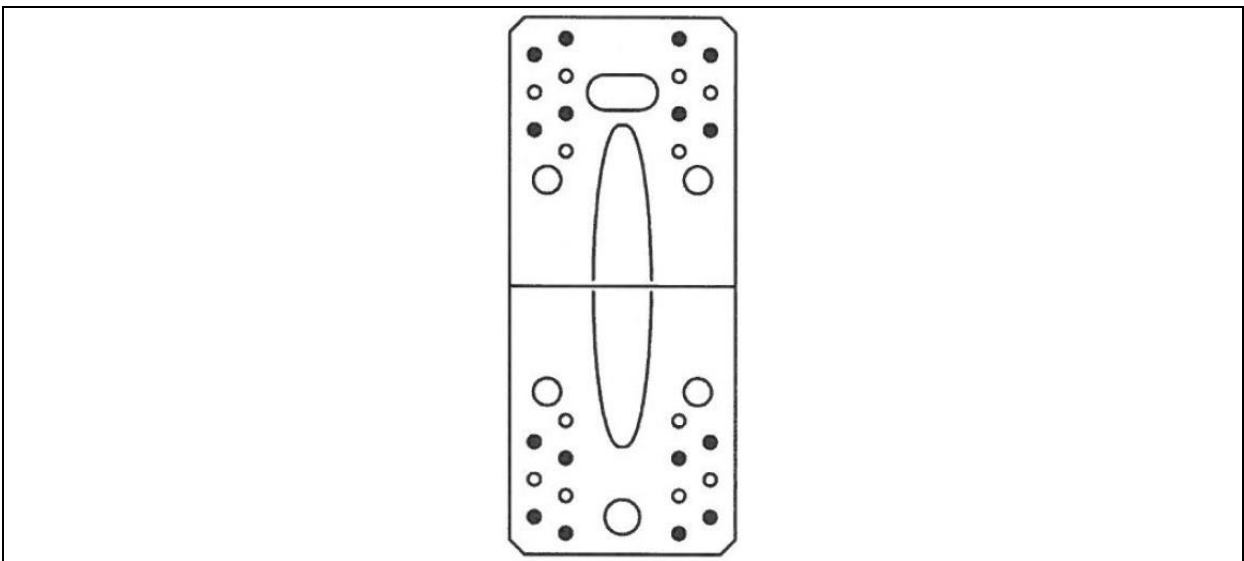
**Figure 158** Type KP 13



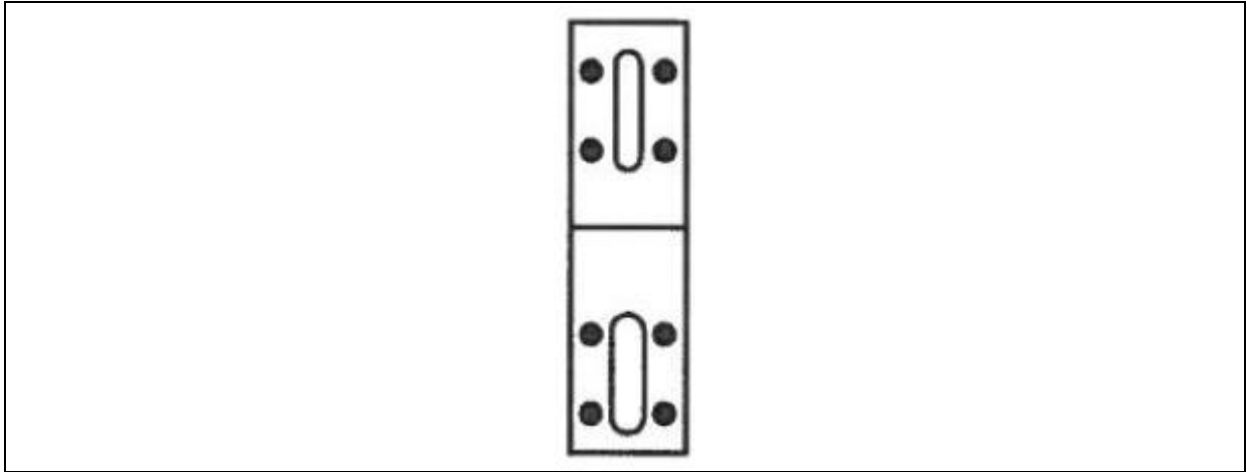
**Figure 159** Type KP 14



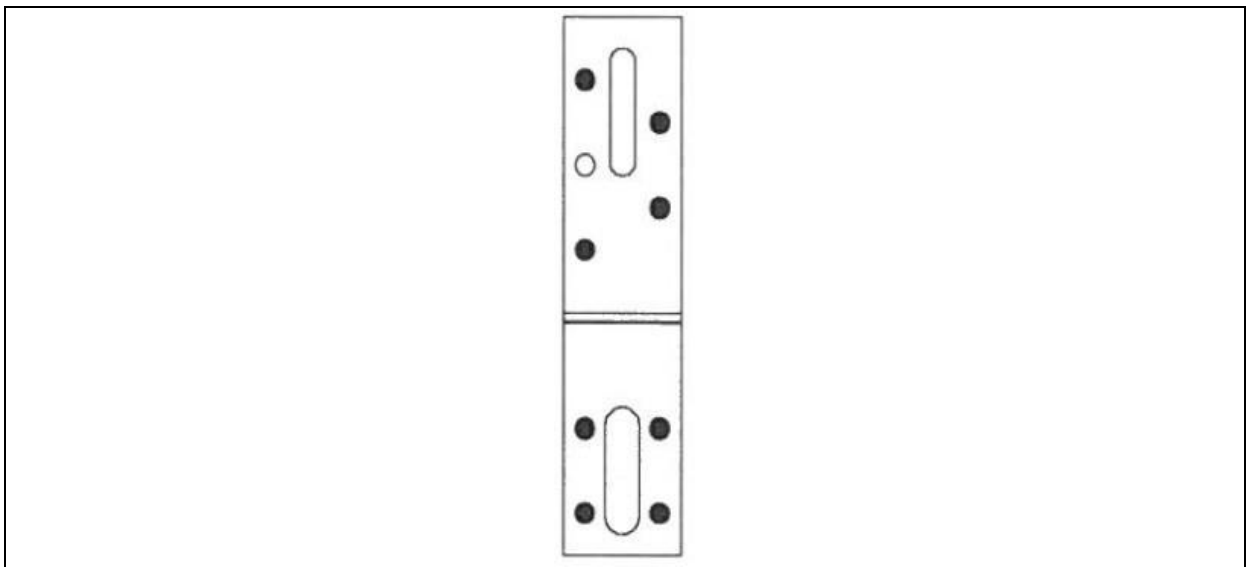
**Figure 160** Type KP 15



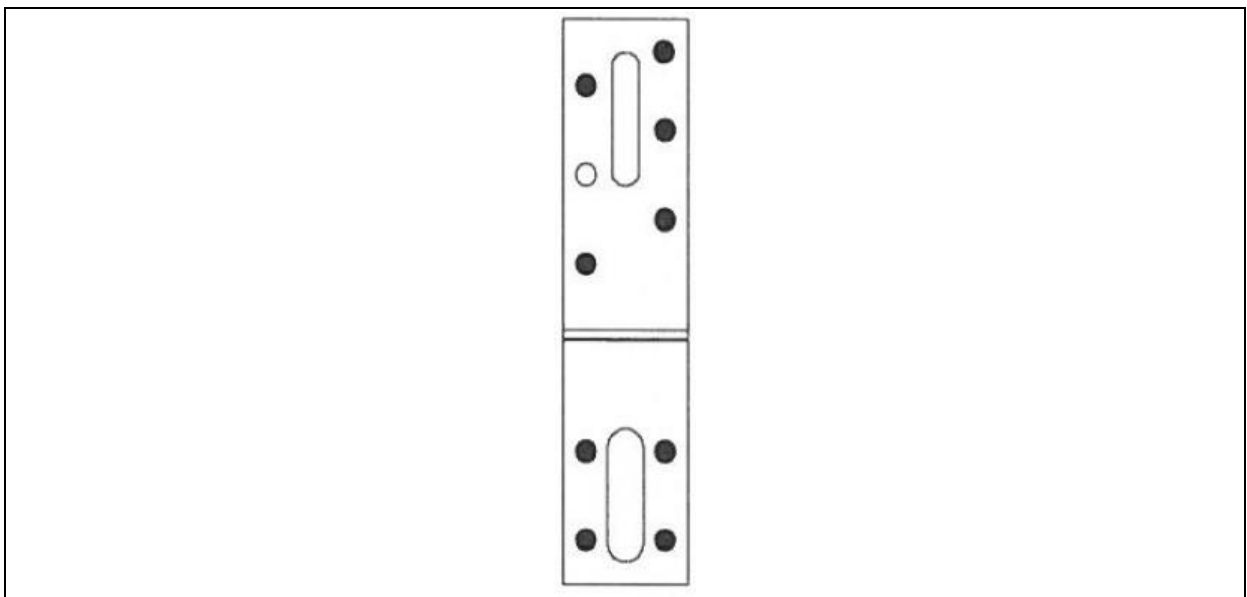
**Figure 161** Type KP 21



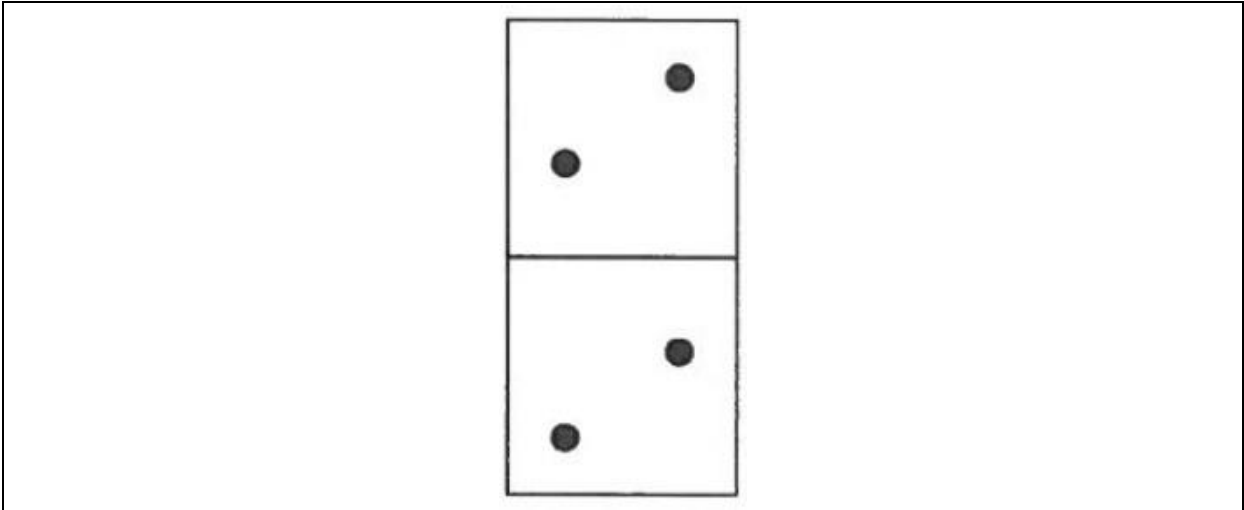
**Figure 162** Type KRD 1



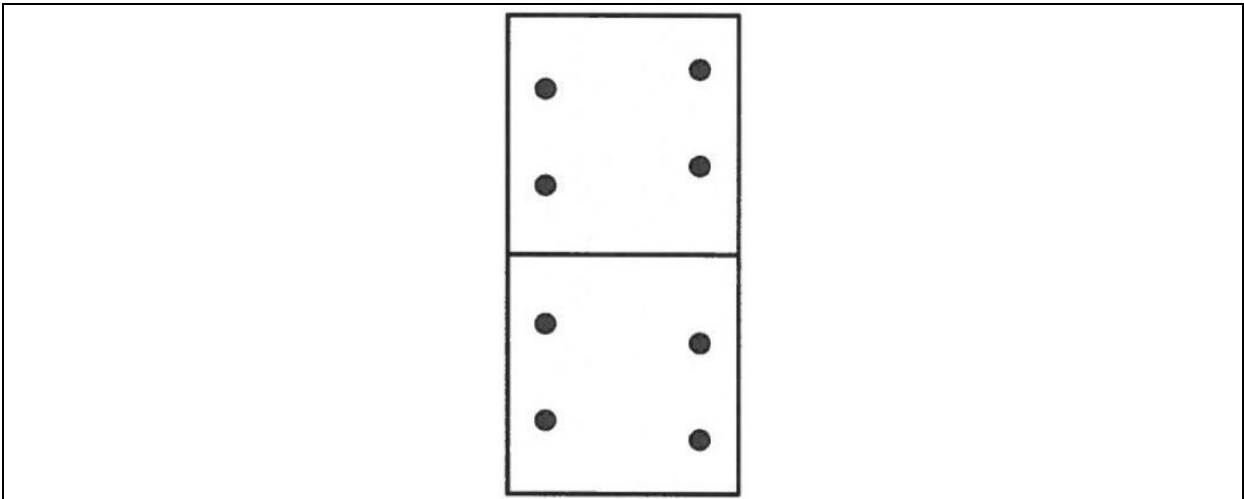
**Figure 163** Type KRD 2



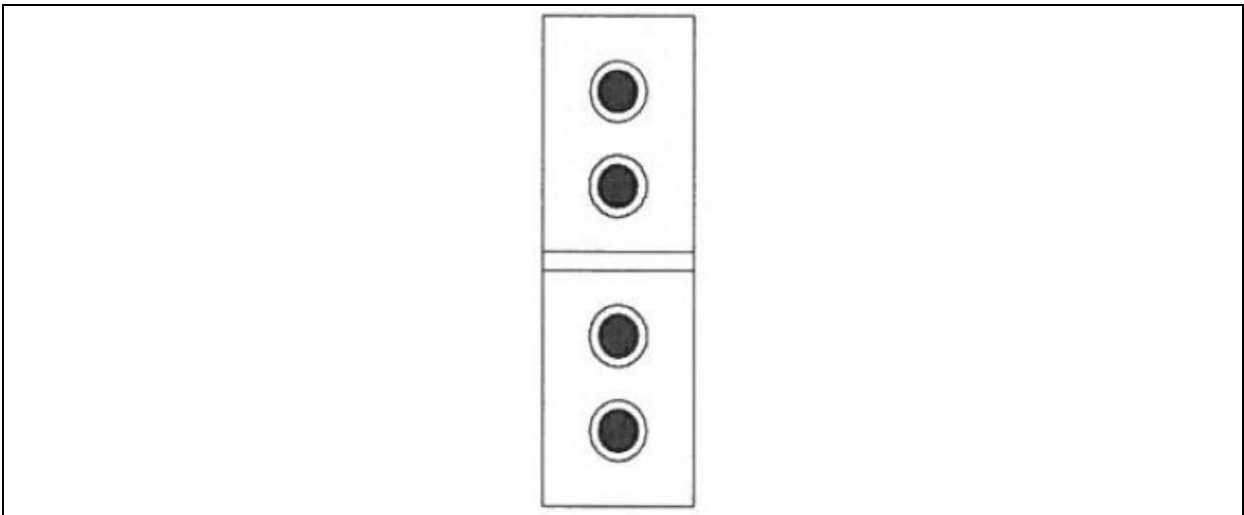
**Figure 164** Type KRD 3 and KRD 4



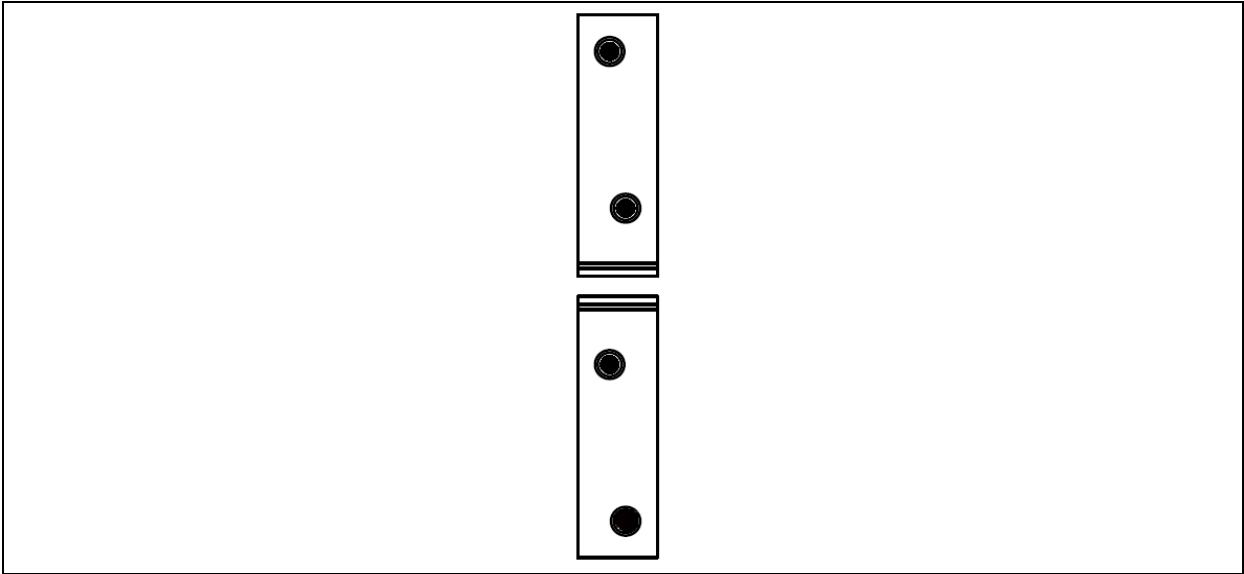
**Figure 165** Type KS 1, KS 2, KSO 1 and KSO 2



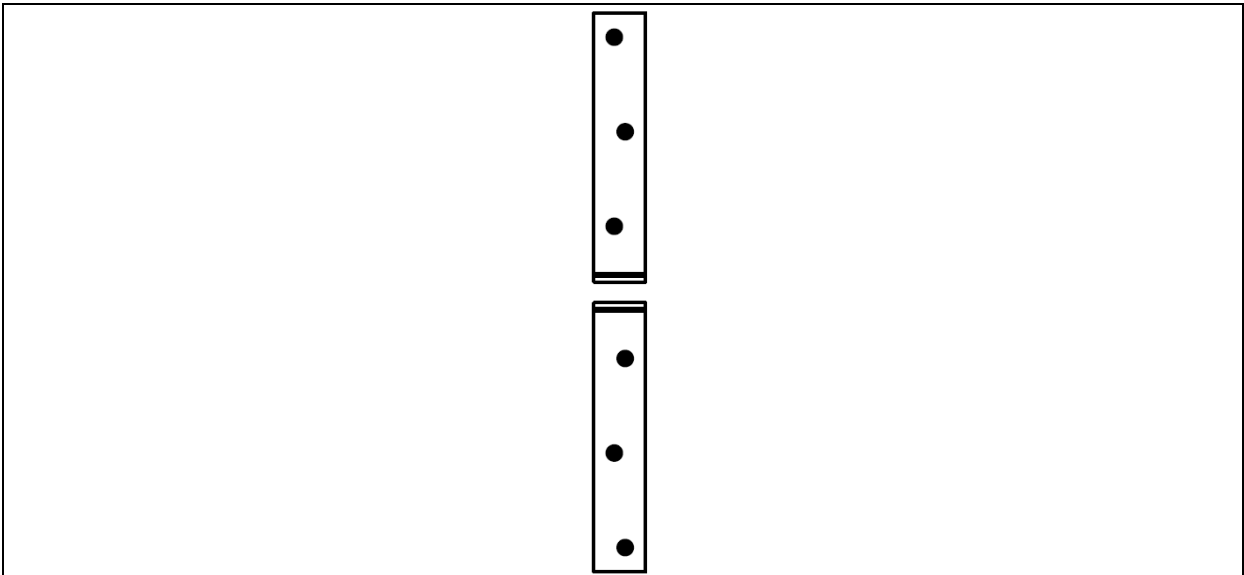
**Figure 166** Type KS 3 and KSO 3



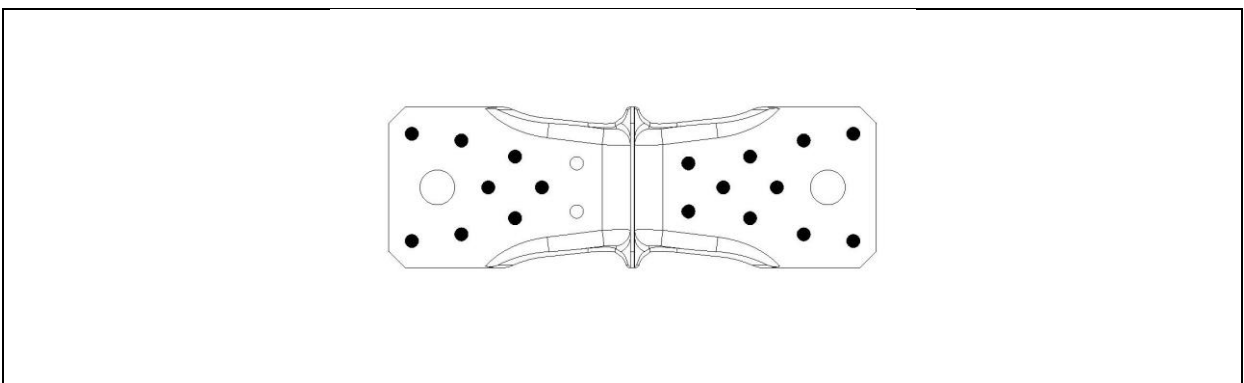
**Figure 167** Type KW 1, KW 2, KW 3, KW 4, KW 5, KW 6, KW 7, KWO 1, KWO 2, KWO 3, KWO 4



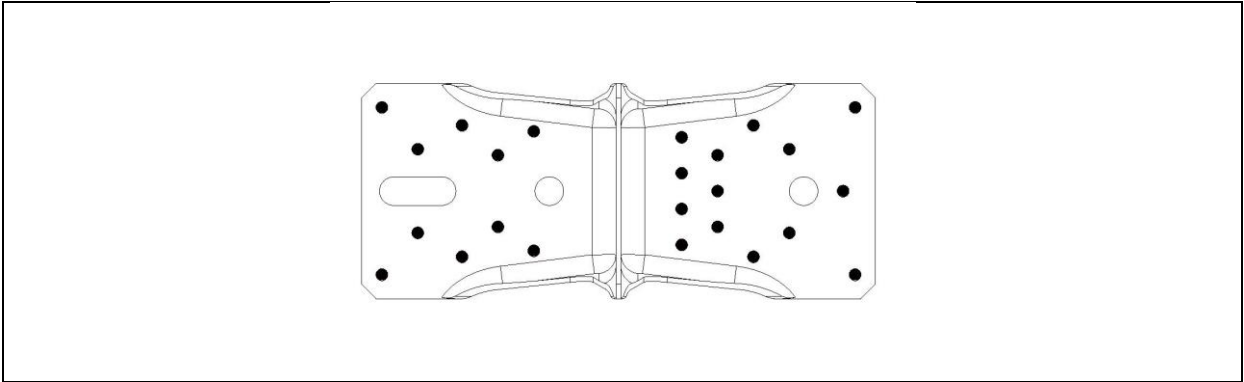
**Figure 168** Type KW 25, KW 30, KW 40, KW 50 and KW 60



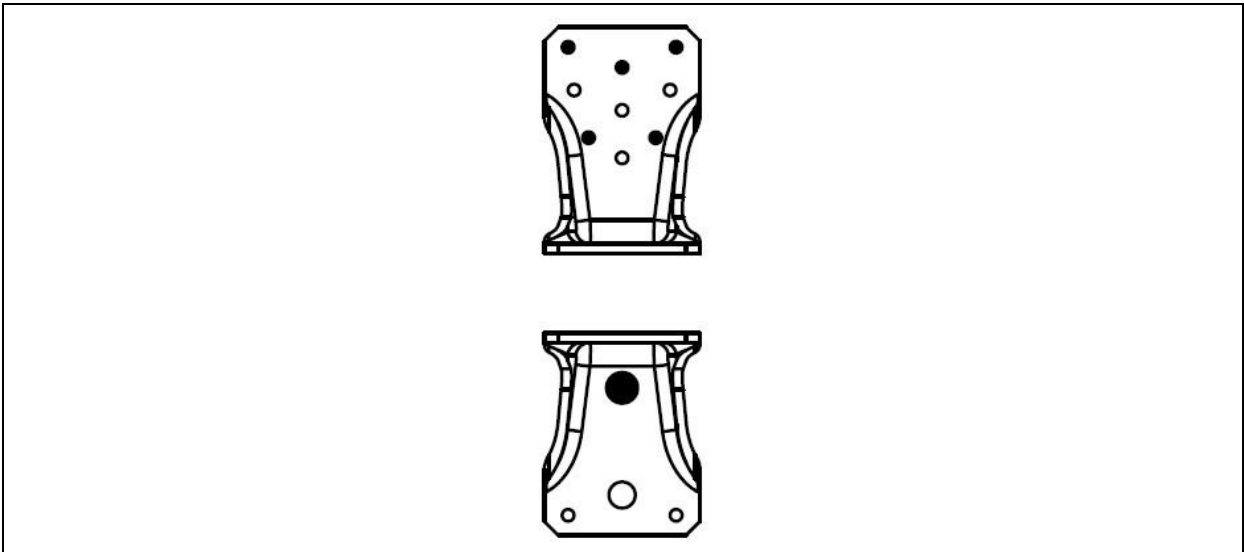
**Figure 169** Type KW 80, KW 100, KW 125, KW 150



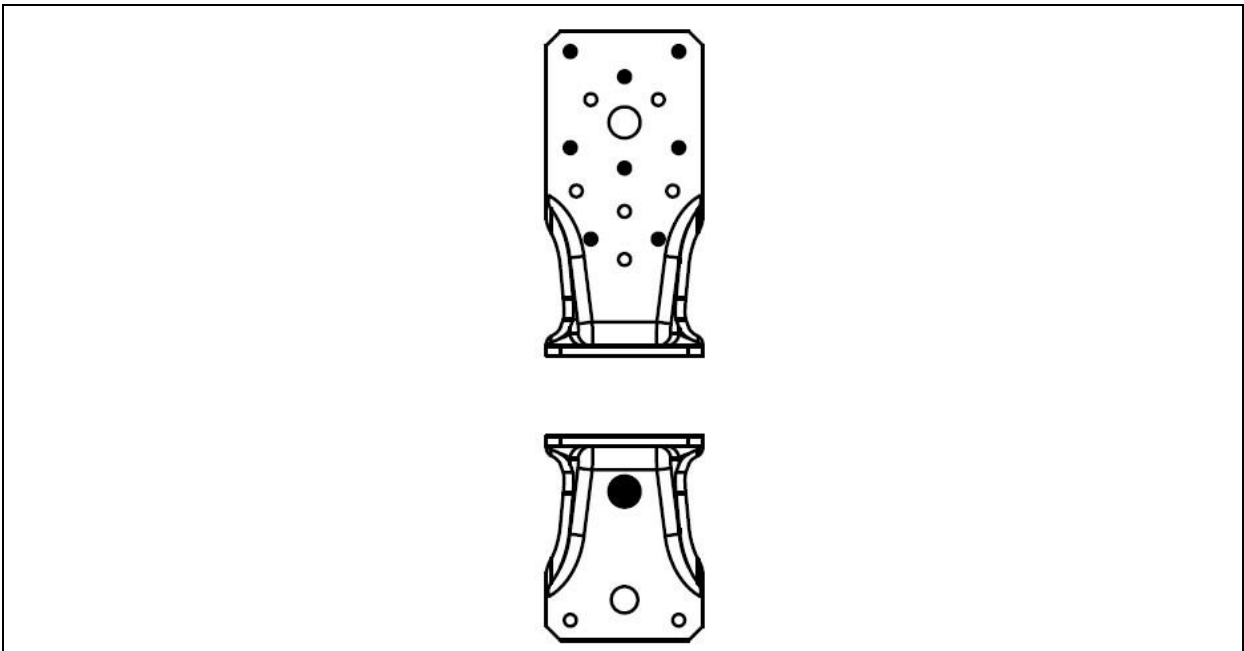
**Figure 170** Type LBS 90



**Figure 171** Type LBS 105



**Figure 172** Type LBZ 95



**Figure 173** Type LBZ 135

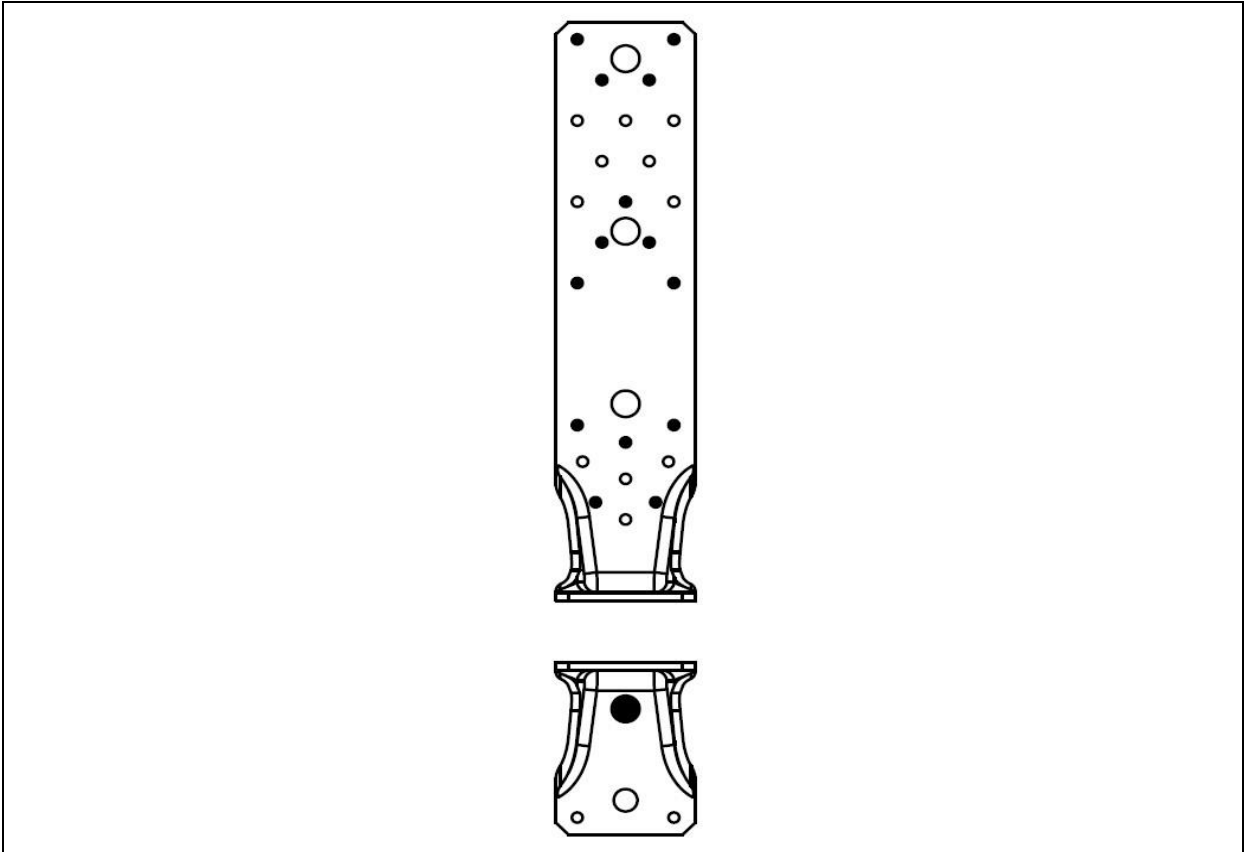


Figure 174 Type LBZ 285

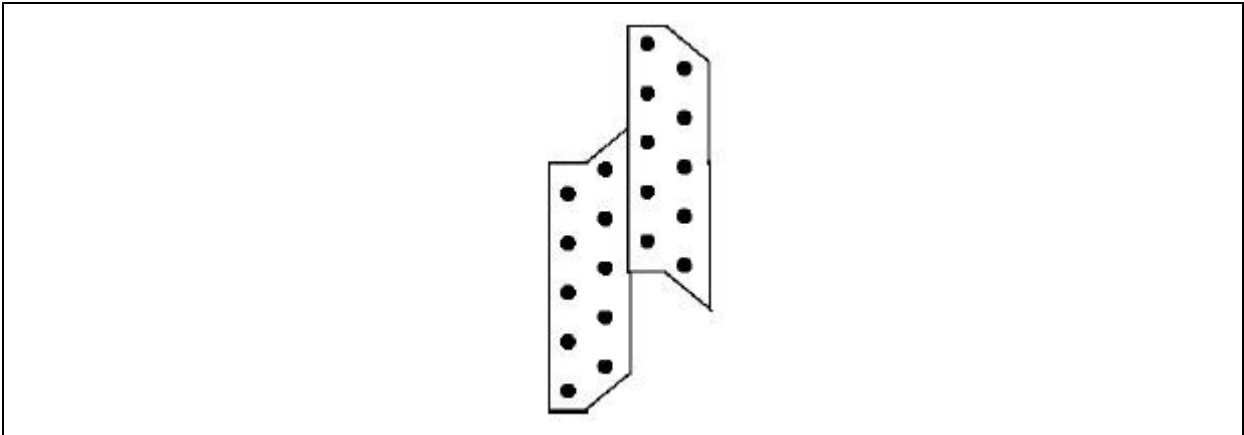
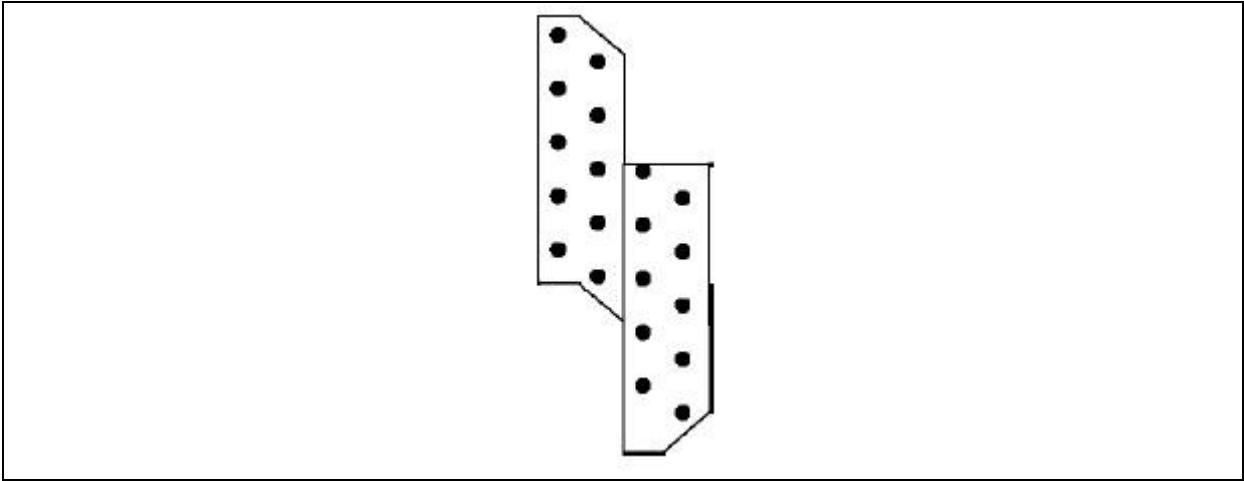
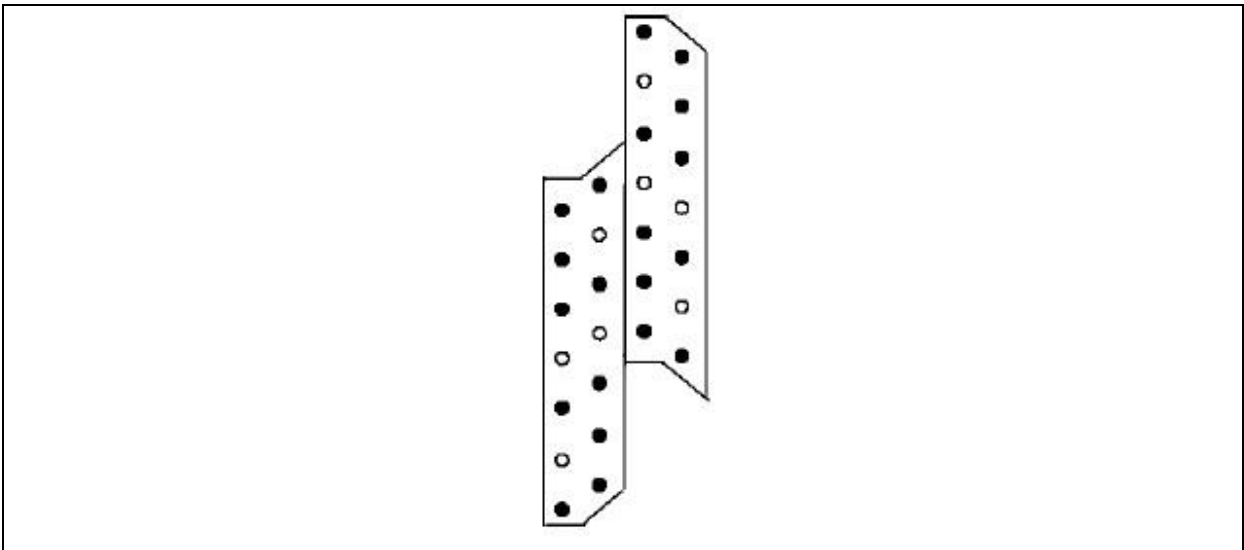


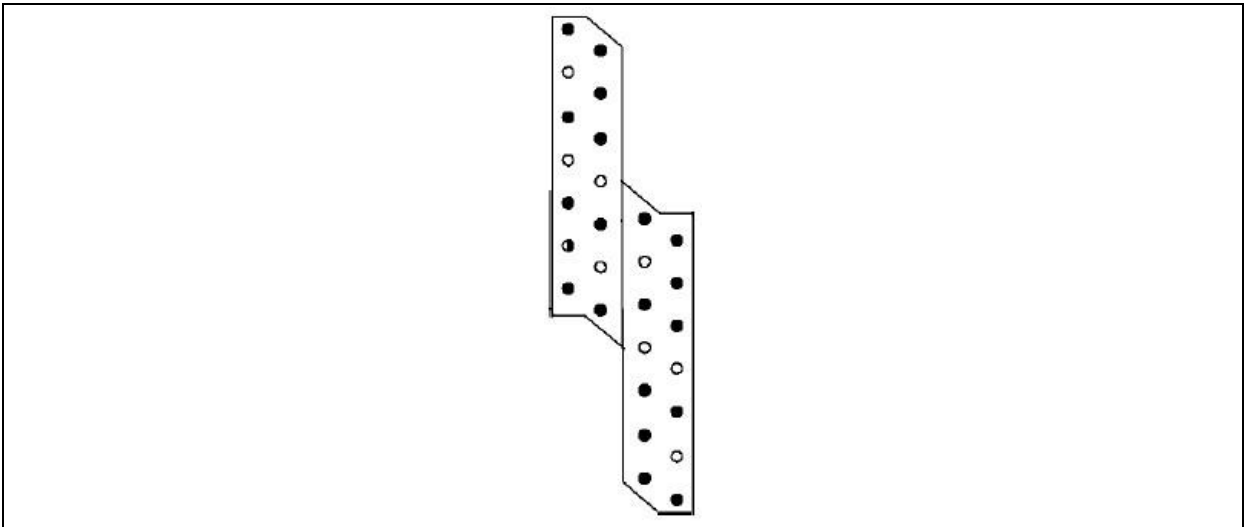
Figure 175 Type LK 1



**Figure 176** Type LK 2



**Figure 177** Type LK 3



**Figure 178** Type LK 4

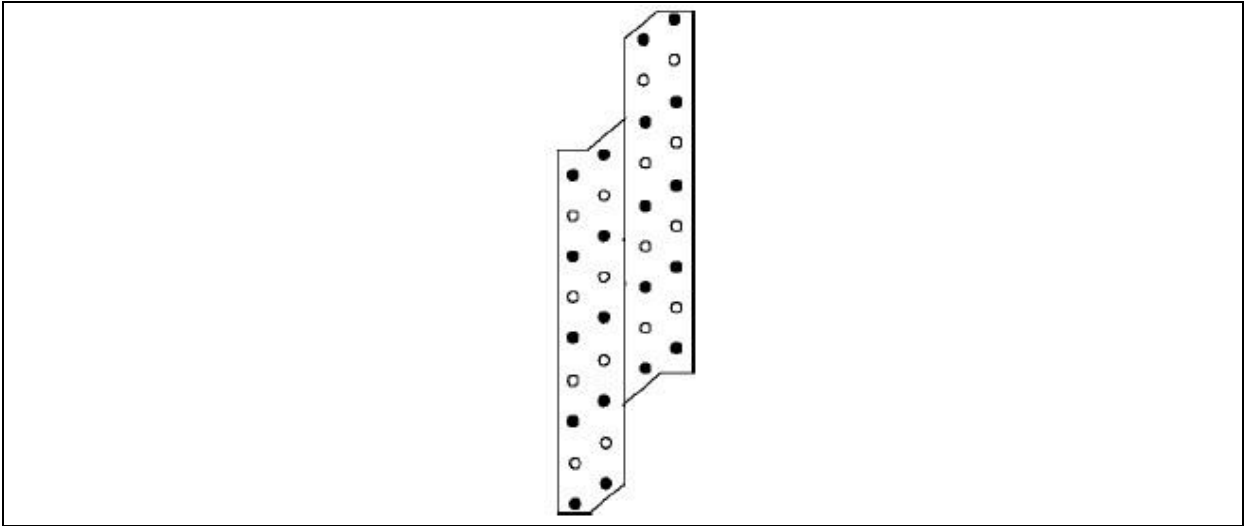


Figure 179 Type LK 5

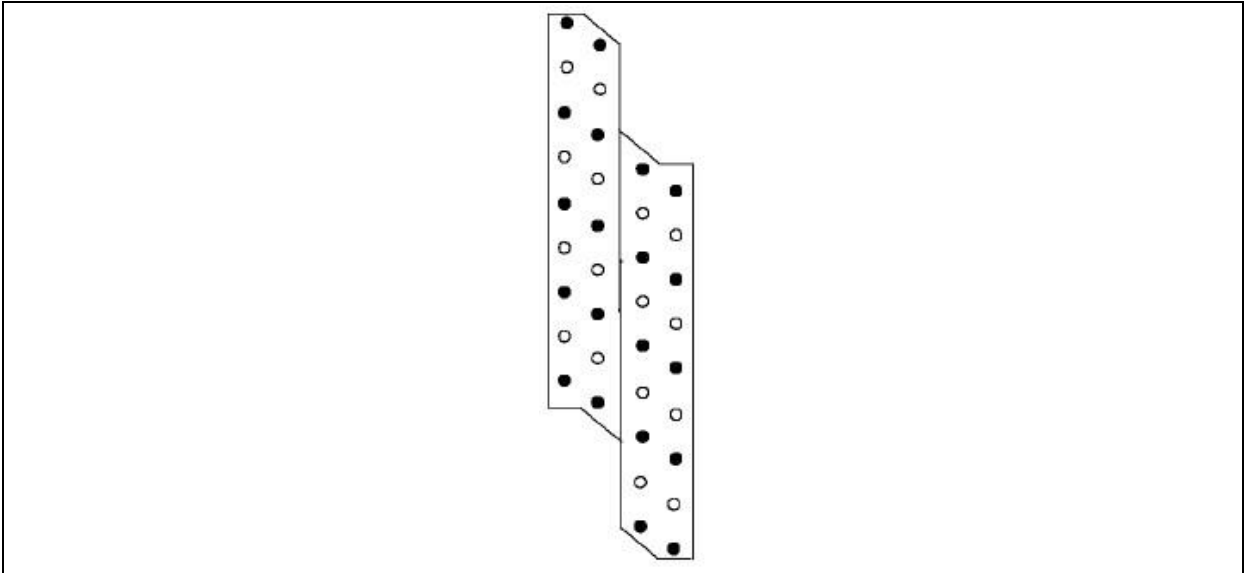


Figure 180 Type LK 6

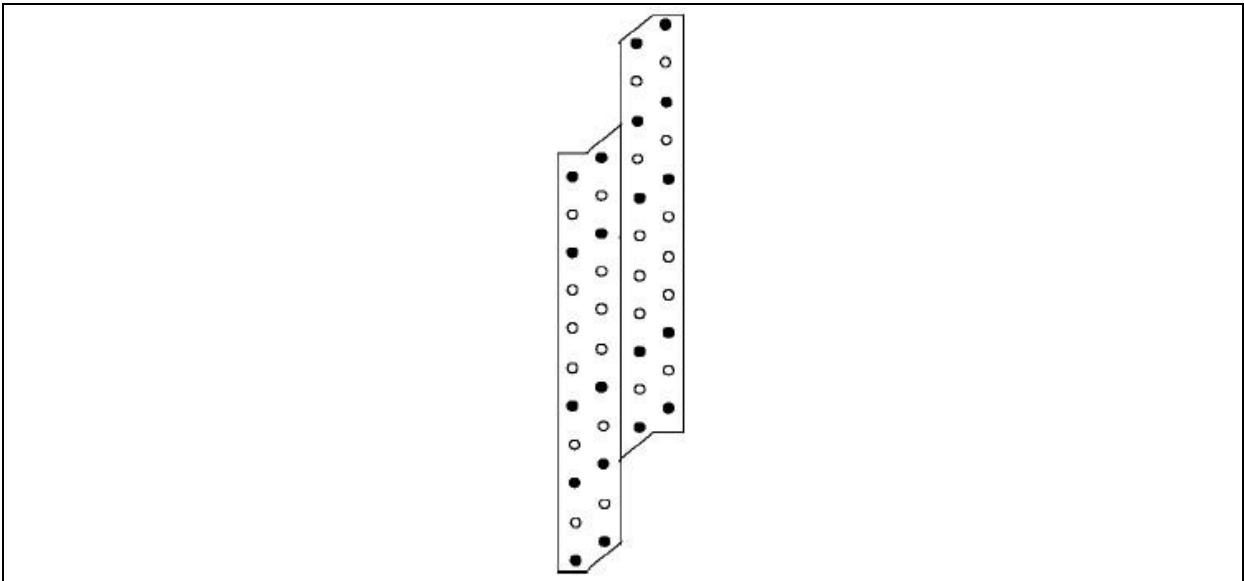


Figure 181 Type LK 7



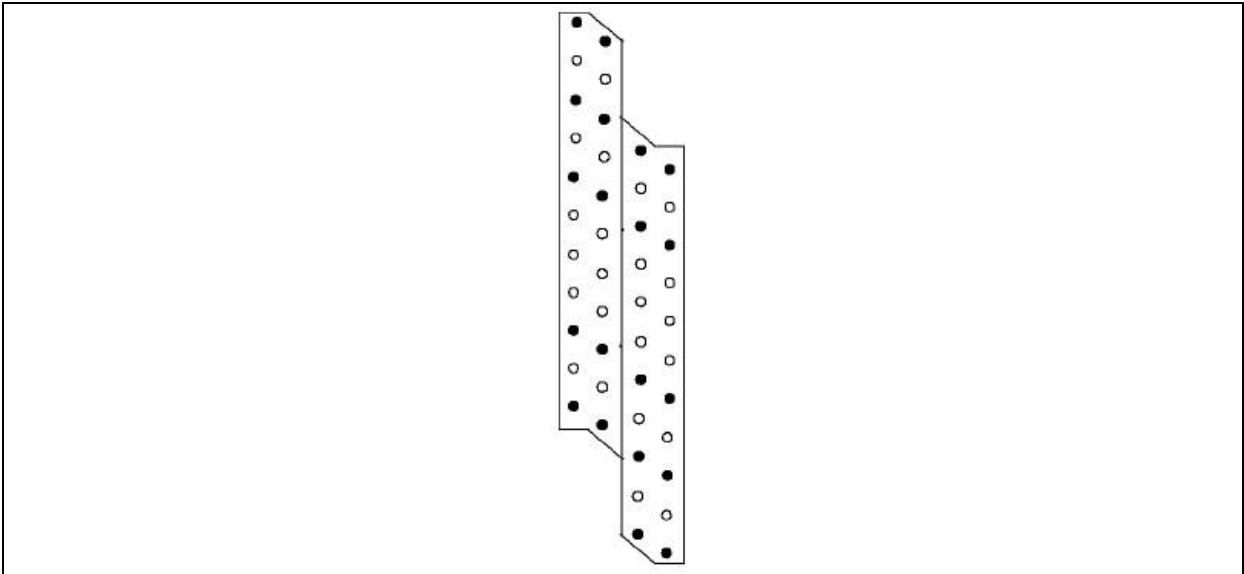


Figure 182 Type LK 8

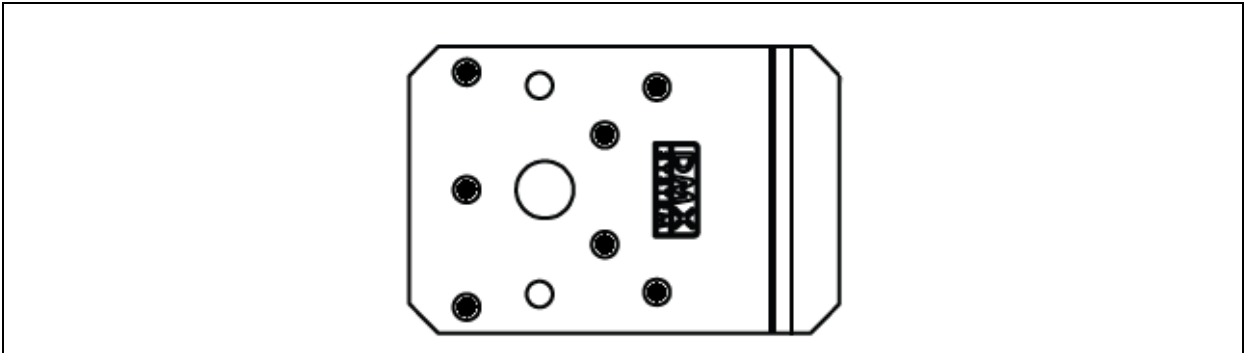


Figure 183 Type LZ 0

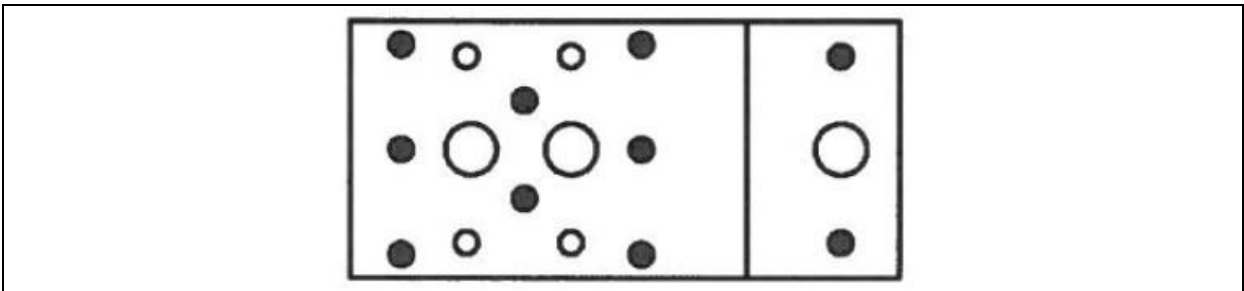
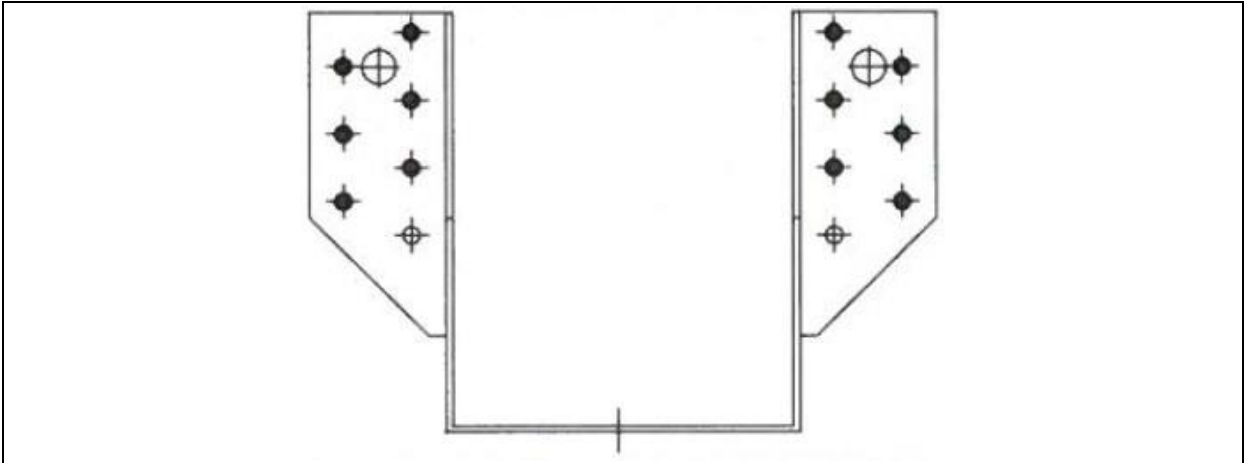
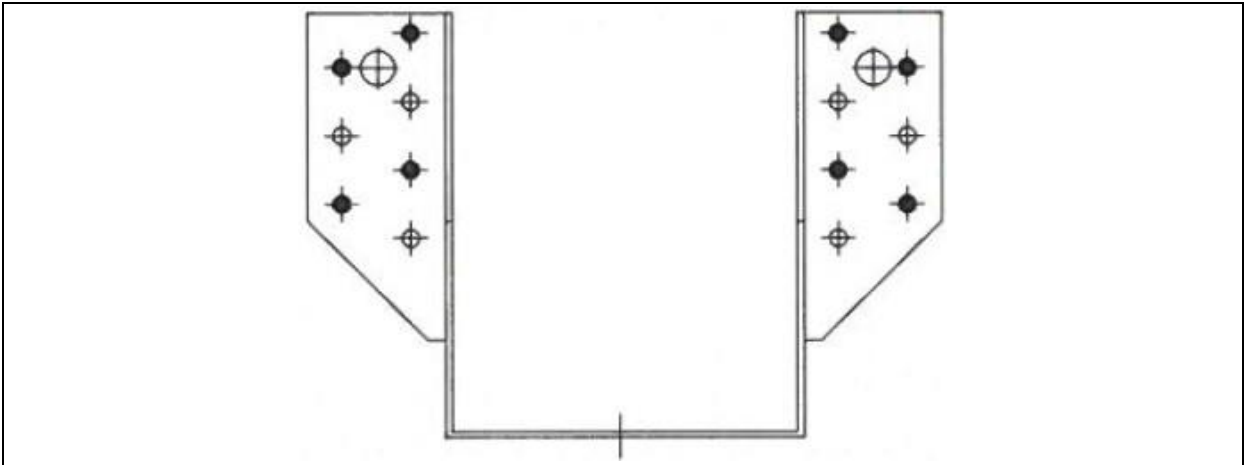


Figure 184 Type LZ 1, LZ 2 and LZ 3

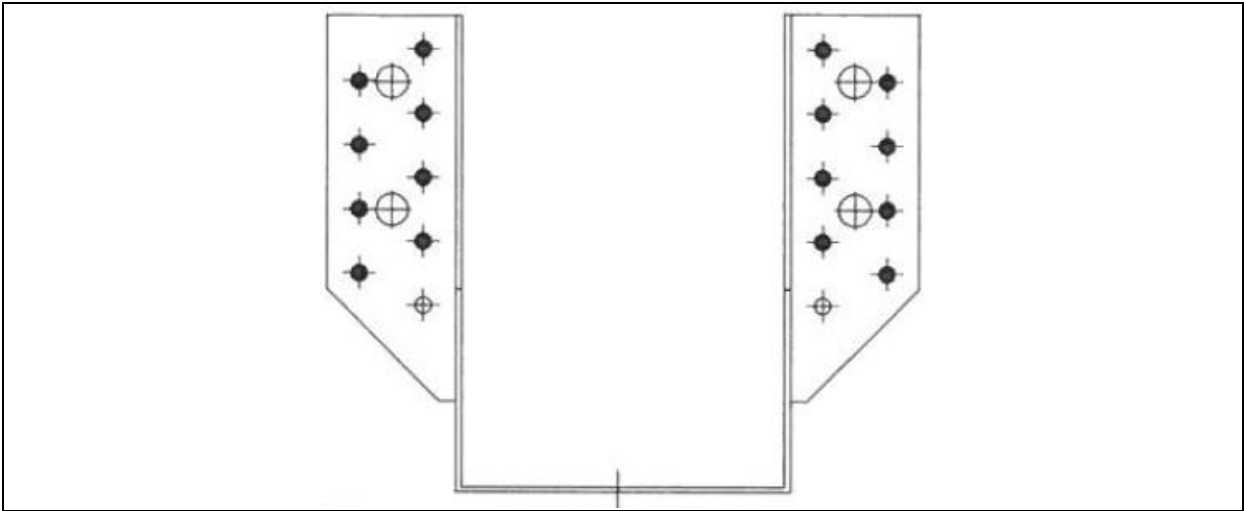


**Figure 185** Type WB 1, WB 2, WB 5, WB 8, WB 10, WB 14, WB 19

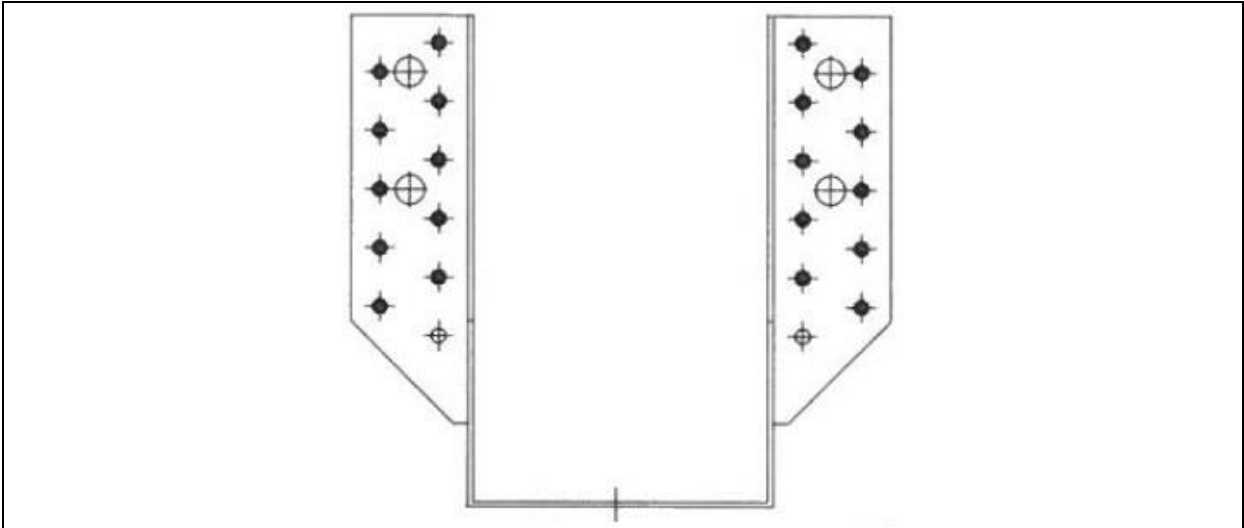


\* Incomplete nailing

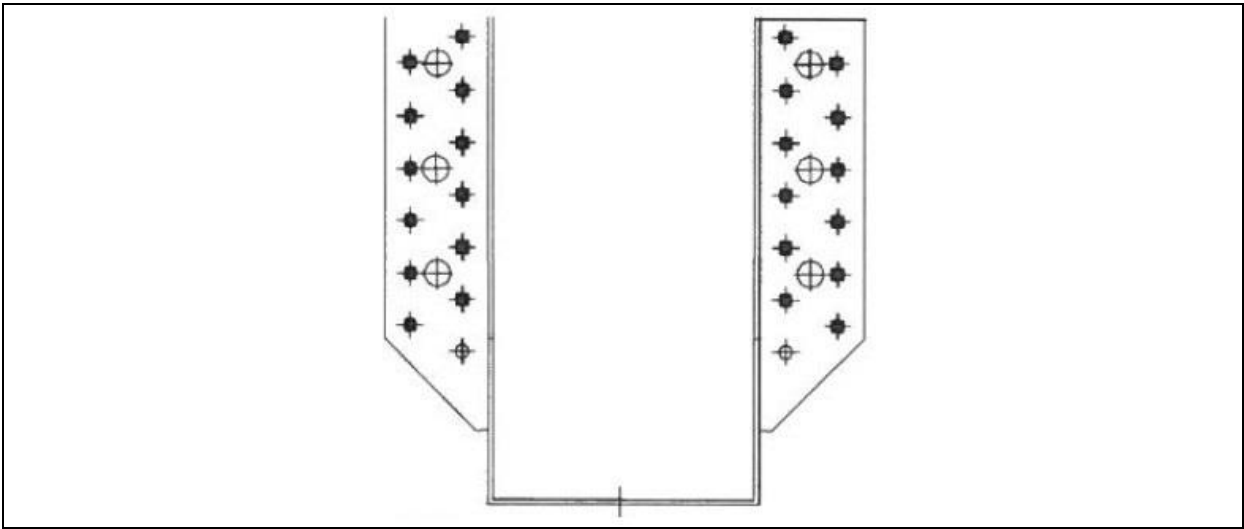
**Figure 186** Type WB 1, WB 2, WB 5, WB 8, WB 10, WB 14, WB 19



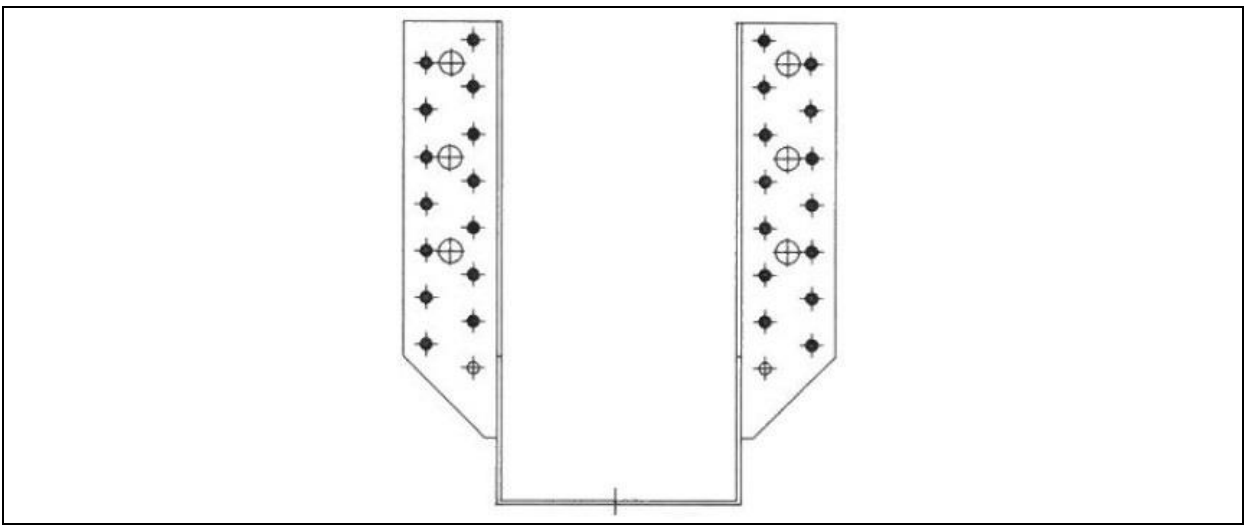
**Figure 187** Type WB 3, WB 6, WB 9, WB 11, WB 15, WB 20, WB 21, WB 23, WB 26



**Figure 188** Type WB 4, WB 7, WB 12, WB 16, WB 22, WB 24, WB 27, WB 30



**Figure 189** Type WB 13, WB 17, WB 25, WB 28, WB 31, WB 33, WB 35



**Figure 190** Type WB 18, WB 29, WB 32, WB 34, WB 36, WB 37, WB 38

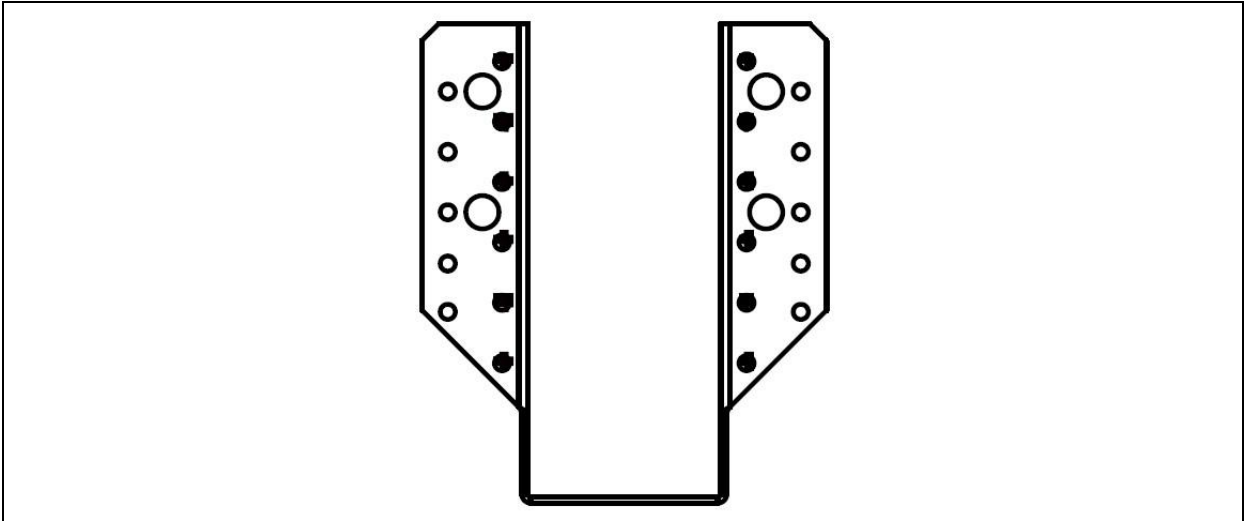


Figure 191 Type WB 64

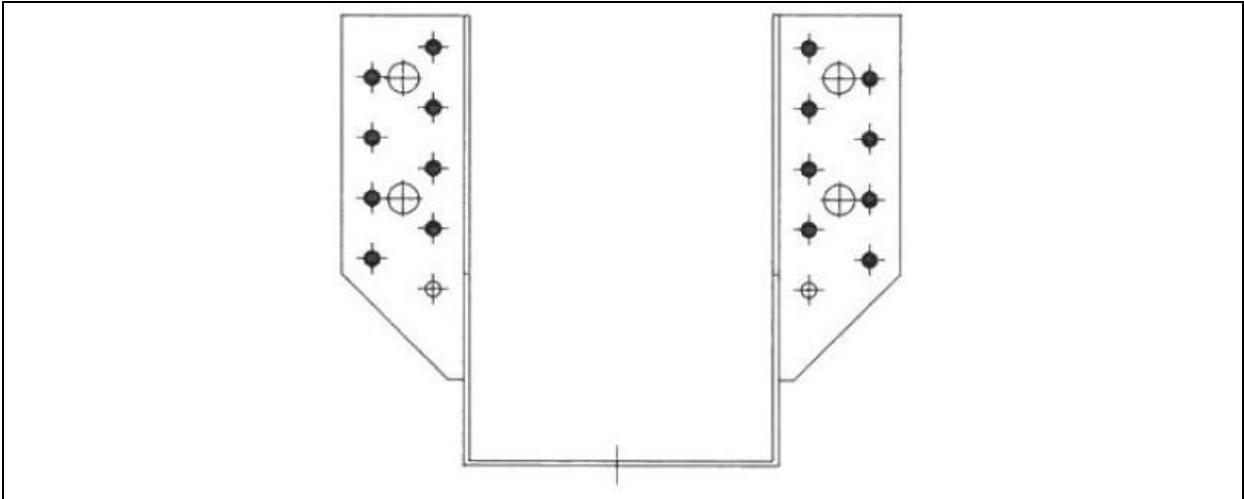


Figure 192 Type WBD 105 L, WBD 105 P, WBD 130 L, WBD 130 P, WBD 140 L, WBD 140 P, WBD 170 L, WBD 170 P, WBD 200 L, WBD 200 P

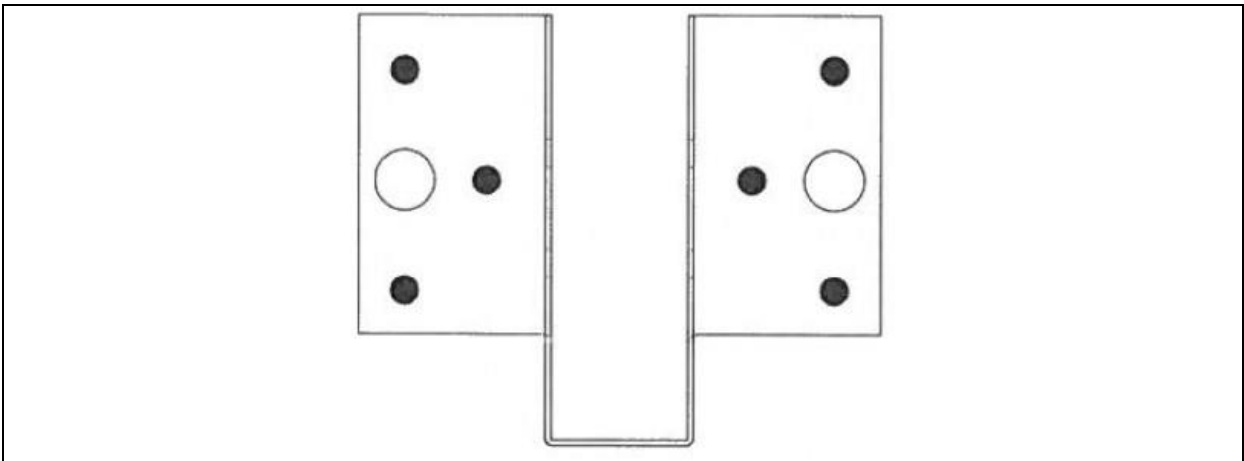
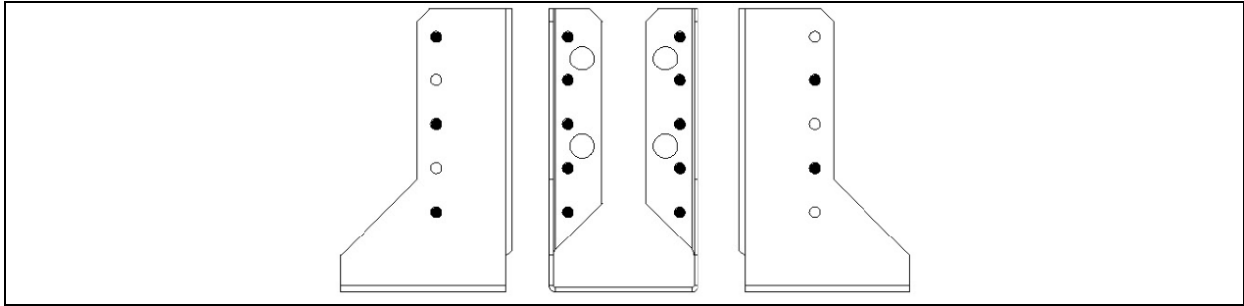
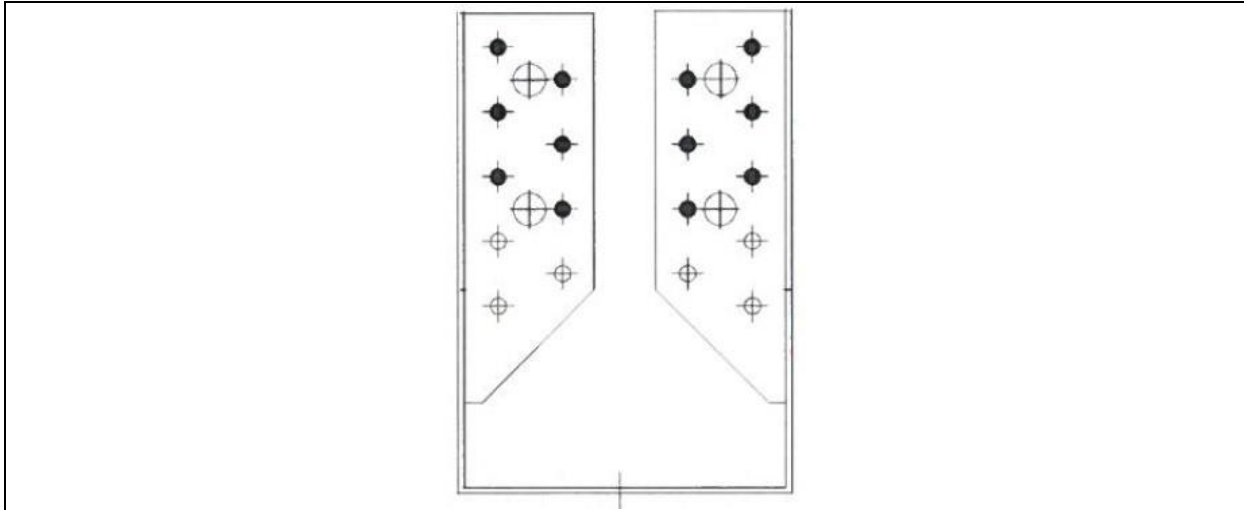


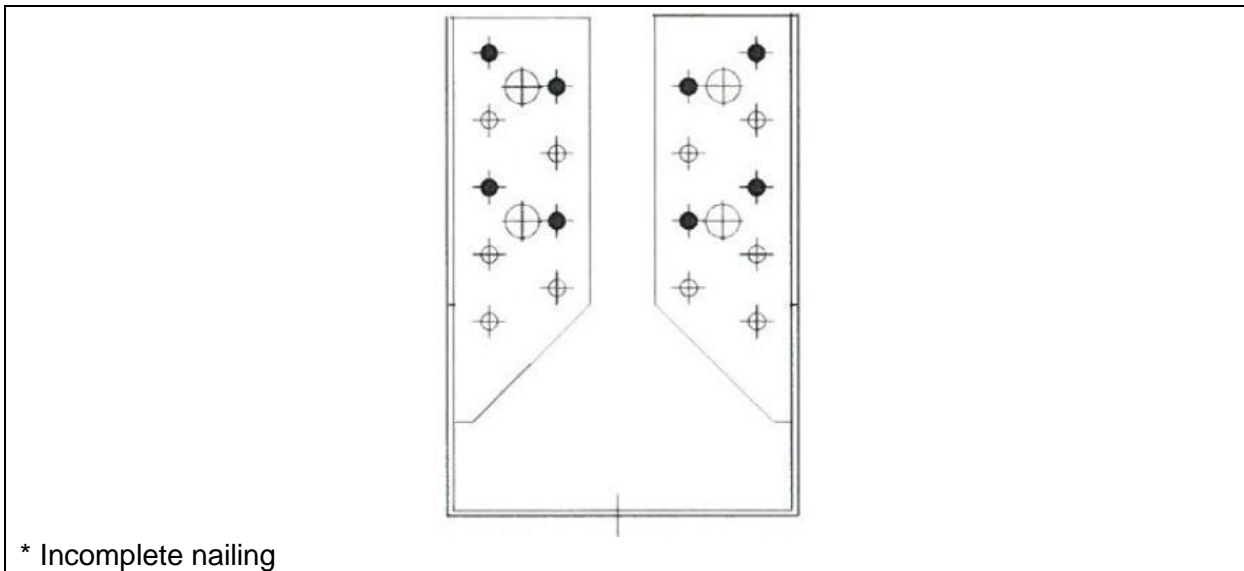
Figure 193 Type WL 5, WL 6, WL 7, WL 8, WL 9



**Figure 194** Type WBZ 20

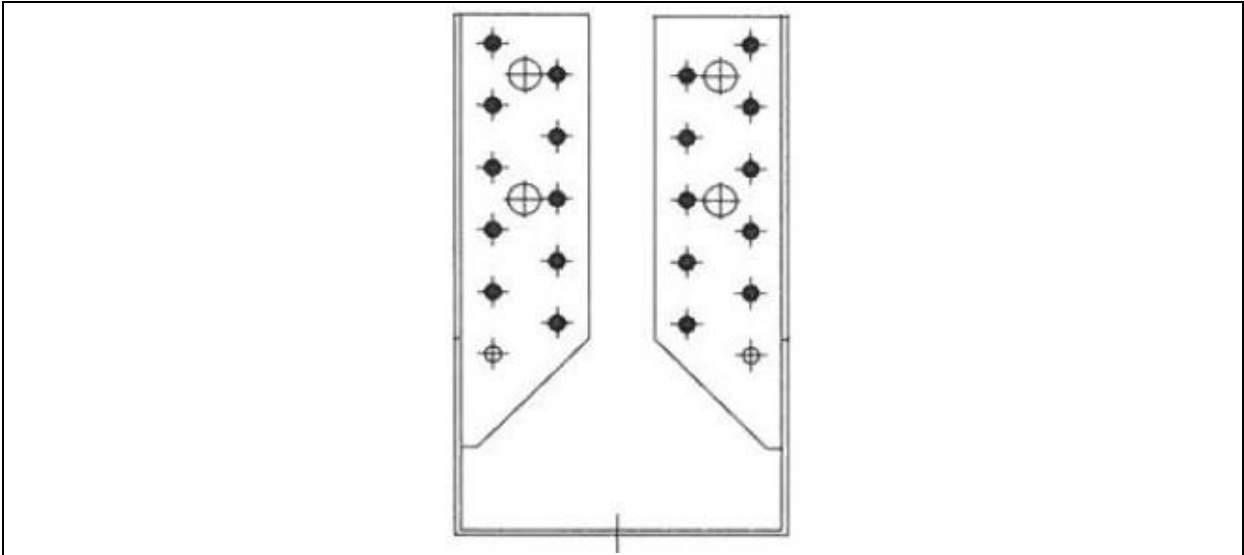


**Figure 195** Type WBZ 21, WBZ 23, WBZ 26

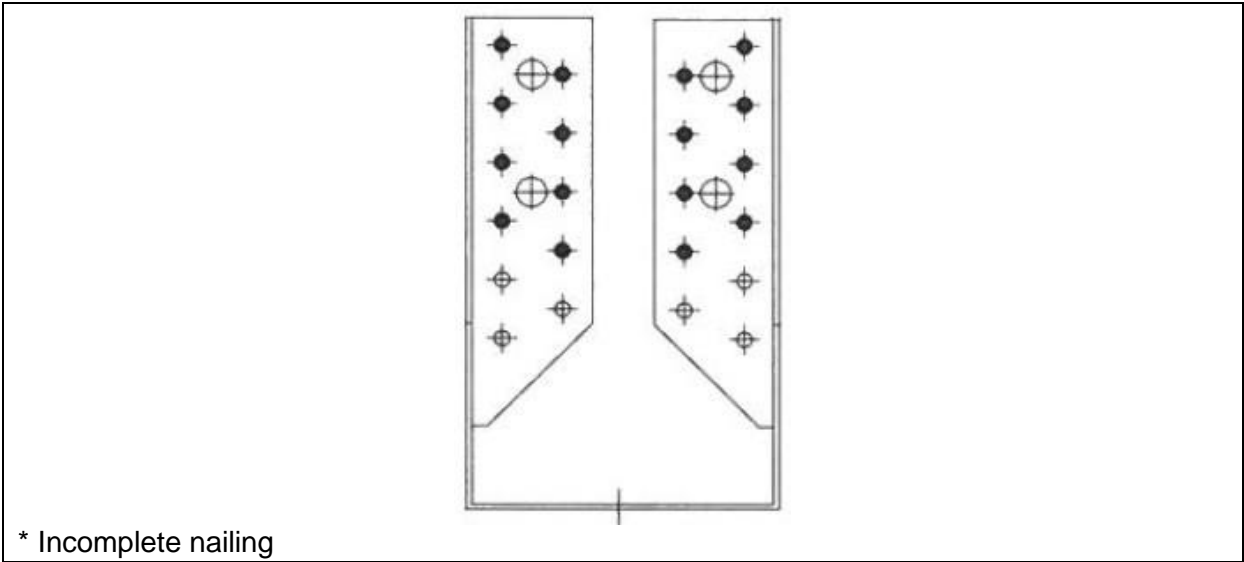


\* Incomplete nailing

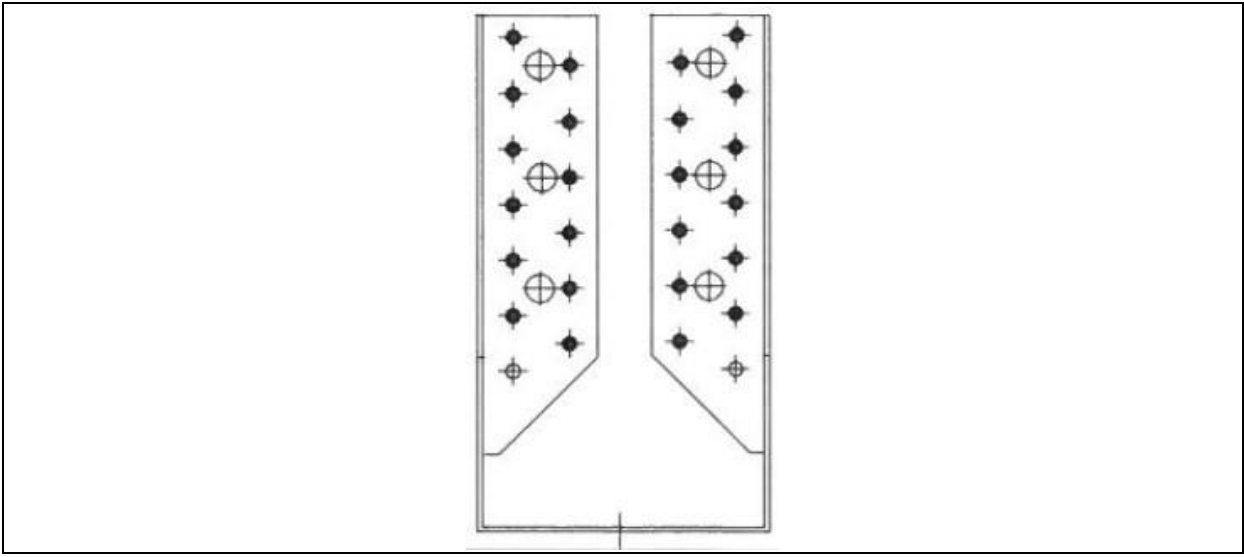
**Figure 196** Type WBZ 21, WBZ 23, WBZ 26



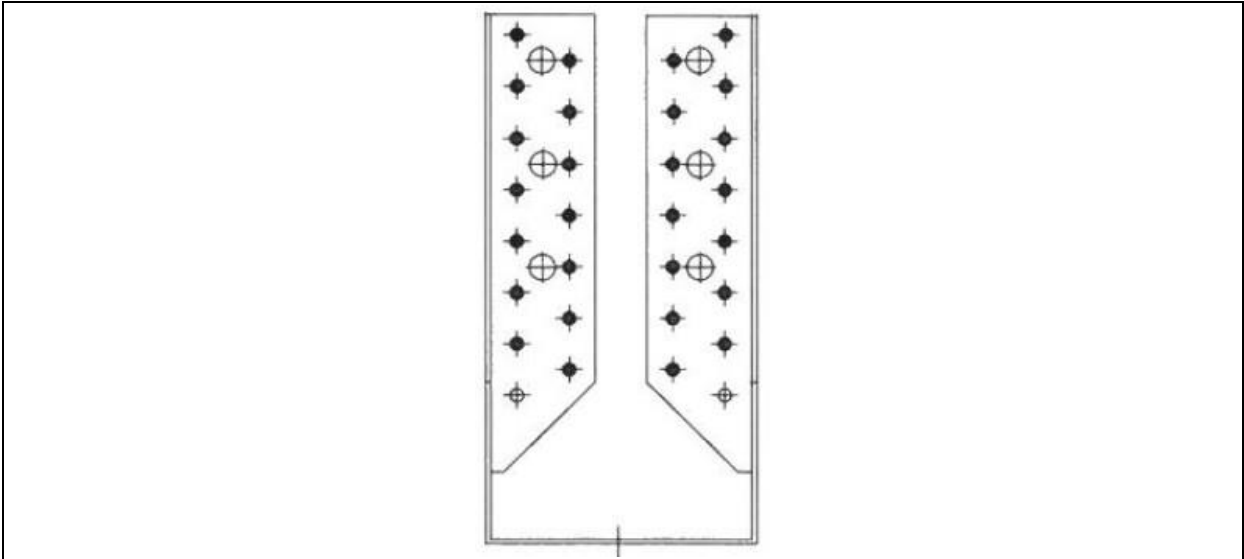
**Figure 197** Type WBZ 22, WBZ 24, WBZ 27, WBZ 30



**Figure 198** Type WBZ 22, WBZ 24, WBZ 27, WBZ 30



**Figure 199** Type WBZ 25, WBZ 28, WBZ 31, WBZ 33, WBZ 35



**Figure 200** Type WBZ 29, WBZ 32, WBZ 34, WBZ 36, WBZ 37

|   |                               |
|---|-------------------------------|
| <b>THREE-DIMENSIONAL NAILING PLATES</b>     | <b>ANNEX 5</b><br>ETA 22/0631 |
| <b>SPECIFICATION OF CONNECTION ELEMENTS</b> |                               |

**Table 79** Specification of connection elements

| Connector | Dowel type fastener       | Fasteners per Detail<br>[pc.] | Fasteners per Connection<br>[pc.] |
|-----------|---------------------------|-------------------------------|-----------------------------------|
| WB 1      | ANCHOR Ø4x50/ANCHOR Ø4x50 | 8\12                          | 8\12                              |
| WB 2      | ANCHOR Ø4x50/ANCHOR Ø4x50 | 8\12                          | 8\12                              |
| WB 3      | ANCHOR Ø4x50/ANCHOR Ø4x50 | 16                            | 16                                |
| WB 4      | ANCHOR Ø4x50/ANCHOR Ø4x50 | 20                            | 20                                |
| WB 5      | ANCHOR Ø4x50/ANCHOR Ø4x50 | 8\12                          | 8\12                              |
| WB 6      | ANCHOR Ø4x50/ANCHOR Ø4x50 | 16                            | 16                                |
| WB 7      | ANCHOR Ø4x50/ANCHOR Ø4x50 | 20                            | 20                                |
| WB 8      | ANCHOR Ø4x50/ANCHOR Ø4x50 | 8\12                          | 8\12                              |
| WB 9      | ANCHOR Ø4x50/ANCHOR Ø4x50 | 16                            | 16                                |
| WB 10     | ANCHOR Ø4x50/ANCHOR Ø4x50 | 8\12                          | 8\12                              |
| WB 11     | ANCHOR Ø4x50/ANCHOR Ø4x50 | 16                            | 16                                |
| WB 12     | ANCHOR Ø4x50/ANCHOR Ø4x50 | 20                            | 20                                |
| WB 13     | ANCHOR Ø4x50/ANCHOR Ø4x50 | 24                            | 24                                |
| WB 14     | ANCHOR Ø4x50/ANCHOR Ø4x50 | 8\12                          | 8\12                              |
| WB 15     | ANCHOR Ø4x50/ANCHOR Ø4x50 | 16                            | 16                                |
| WB 16     | ANCHOR Ø4x50/ANCHOR Ø4x50 | 20                            | 20                                |
| WB 17     | ANCHOR Ø4x50/ANCHOR Ø4x50 | 24                            | 24                                |
| WB 18     | ANCHOR Ø4x50/ANCHOR Ø4x50 | 28                            | 28                                |
| WB 19     | ANCHOR Ø4x50/ANCHOR Ø4x50 | 8\12                          | 8\12                              |
| WB 20     | ANCHOR Ø4x50/ANCHOR Ø4x50 | 16                            | 16                                |
| WB 21     | ANCHOR Ø4x50/ANCHOR Ø4x50 | 16                            | 16                                |
| WB 22     | ANCHOR Ø4x50/ANCHOR Ø4x50 | 20                            | 20                                |
| WB 23     | ANCHOR Ø4x50/ANCHOR Ø4x50 | 16                            | 16                                |
| WB 24     | ANCHOR Ø4x50/ANCHOR Ø4x50 | 20                            | 20                                |
| WB 25     | ANCHOR Ø4x50/ANCHOR Ø4x50 | 24                            | 24                                |
| WB 26     | ANCHOR Ø4x50/ANCHOR Ø4x50 | 16                            | 16                                |
| WB 27     | ANCHOR Ø4x50/ANCHOR Ø4x50 | 20                            | 20                                |
| WB 28     | ANCHOR Ø4x50/ANCHOR Ø4x50 | 24                            | 24                                |
| WB 29     | ANCHOR Ø4x50/ANCHOR Ø4x50 | 28                            | 28                                |
| WB 30     | ANCHOR Ø4x50/ANCHOR Ø4x50 | 20                            | 20                                |
| WB 31     | ANCHOR Ø4x50/ANCHOR Ø4x50 | 24                            | 24                                |
| WB 32     | ANCHOR Ø4x50/ANCHOR Ø4x50 | 28                            | 28                                |
| WB 33     | ANCHOR Ø4x50/ANCHOR Ø4x50 | 24                            | 24                                |
| WB 34     | ANCHOR Ø4x50/ANCHOR Ø4x50 | 28                            | 28                                |
| WB 35     | ANCHOR Ø4x50/ANCHOR Ø4x50 | 24                            | 24                                |
| WB 36     | ANCHOR Ø4x50/ANCHOR Ø4x50 | 28                            | 28                                |
| WB 37     | ANCHOR Ø4x50/ANCHOR Ø4x50 | 28                            | 28                                |
| WB 38     | ANCHOR Ø4x50/ANCHOR Ø4x50 | 28                            | 28                                |



| Connector | Dowel type fastener       | Fasteners per Detail [pc.] | Fasteners per Connection [pc.] |
|-----------|---------------------------|----------------------------|--------------------------------|
| WB 64     | ANCHOR Ø4x50/ANCHOR Ø4x50 | 12                         | 12                             |
| WBZ 20    | Anchor Ø4x50              | 10/5                       | 10/5                           |
| WBZ 21    | ANCHOR Ø4x50/ANCHOR Ø4x50 | 8\12                       | 8\12                           |
| WBZ 22    | ANCHOR Ø4x50/ANCHOR Ø4x50 | 16\20                      | 16\20                          |
| WBZ 23    | ANCHOR Ø4x50/ANCHOR Ø4x50 | 8\12                       | 8\12                           |
| WBZ 24    | ANCHOR Ø4x50/ANCHOR Ø4x50 | 16\20                      | 16\20                          |
| WBZ 25    | ANCHOR Ø4x50/ANCHOR Ø4x50 | 24                         | 24                             |
| WBZ 26    | ANCHOR Ø4x50/ANCHOR Ø4x50 | 8\12                       | 8\12                           |
| WBZ 27    | ANCHOR Ø4x50/ANCHOR Ø4x50 | 16\20                      | 16\20                          |
| WBZ 28    | ANCHOR Ø4x50/ANCHOR Ø4x50 | 24                         | 24                             |
| WBZ 29    | ANCHOR Ø4x50/ANCHOR Ø4x50 | 28                         | 28                             |
| WBZ 30    | ANCHOR Ø4x50/ANCHOR Ø4x50 | 16\20                      | 16\20                          |
| WBZ 31    | ANCHOR Ø4x50/ANCHOR Ø4x50 | 24                         | 24                             |
| WBZ 32    | ANCHOR Ø4x50/ANCHOR Ø4x50 | 28                         | 28                             |
| WBZ 33    | ANCHOR Ø4x50/ANCHOR Ø4x50 | 24                         | 24                             |
| WBZ 34    | ANCHOR Ø4x50/ANCHOR Ø4x50 | 28                         | 28                             |
| WBZ 35    | ANCHOR Ø4x50/ANCHOR Ø4x50 | 24                         | 24                             |
| WBZ 36    | ANCHOR Ø4x50/ANCHOR Ø4x50 | 28                         | 28                             |
| WBZ 37    | ANCHOR Ø4x50/ANCHOR Ø4x50 | 28                         | 28                             |
| WBD 105L  | ANCHOR Ø4x50/ANCHOR Ø4x50 | 16                         | 32                             |
| WBD 105P  | ANCHOR Ø4x50/ANCHOR Ø4x50 | 16                         | 32                             |
| WBD 130L  | ANCHOR Ø4x50/ANCHOR Ø4x50 | 16                         | 32                             |
| WBD130P   | ANCHOR Ø4x50/ANCHOR Ø4x50 | 16                         | 32                             |
| WBD 140L  | ANCHOR Ø4x50/ANCHOR Ø4x50 | 16                         | 32                             |
| WBD 140P  | ANCHOR Ø4x50/ANCHOR Ø4x50 | 16                         | 32                             |
| WBD 170L  | ANCHOR Ø4x50/ANCHOR Ø4x50 | 16                         | 32                             |
| WBD 170P  | ANCHOR Ø4x50/ANCHOR Ø4x50 | 16                         | 32                             |
| WBD 200L  | ANCHOR Ø4x50/ANCHOR Ø4x50 | 16                         | 32                             |
| WBD 200P  | ANCHOR Ø4x50/ANCHOR Ø4x50 | 16                         | 32                             |
| LK 1      | ANCHOR Ø4x50              | 20                         | 40                             |
| LK 2      | ANCHOR Ø4x50              | 20                         | 40                             |
| LK 3      | ANCHOR Ø4x50              | 20                         | 40                             |
| LK 4      | ANCHOR Ø4x50              | 20                         | 40                             |
| LK 5      | ANCHOR Ø4x50              | 20                         | 40                             |
| LK 6      | ANCHOR Ø4x50              | 20                         | 40                             |
| LK 7      | ANCHOR Ø4x50              | 20                         | 40                             |
| LK 8      | ANCHOR Ø4x50              | 20                         | 40                             |
| KG        | ANCHOR Ø3.1x50            | 14                         | 28                             |
| WL 5      | ANCHOR Ø4x50/ANCHOR Ø4x50 | 6                          | 6                              |
| WL 6      | ANCHOR Ø4x50/ANCHOR Ø4x50 | 6                          | 6                              |
| WL 7      | ANCHOR Ø4x50/ANCHOR Ø4x50 | 6                          | 6                              |

| Connector | Dowel type fastener       | Fasteners per Detail [pc.] | Fasteners per Connection [pc.] |
|-----------|---------------------------|----------------------------|--------------------------------|
| WL 8      | ANCHOR Ø4x50/ANCHOR Ø4x50 | 6                          | 6                              |
| WL 9      | ANCHOR Ø4x50/ANCHOR Ø4x50 | 6                          | 6                              |
| KRD 1     | ANCHOR Ø4x50              | 8                          | 16                             |
| KRD 2     | ANCHOR Ø4x50              | 8                          | 16                             |
| KRD 3     | ANCHOR Ø4x50              | 9                          | 18                             |
| KRD 4     | ANCHOR Ø4x50              | 9                          | 18                             |
| KMP 1     | ANCHOR Ø4x50              | 8                          | 16                             |
| KMP 2     | ANCHOR Ø4x50              | 8                          | 16                             |
| KMP 3     | ANCHOR Ø4x50              | 8                          | 16                             |
| KMP 4     | ANCHOR Ø4x50              | 8                          | 16                             |
| KMP 5     | ANCHOR Ø4x50              | 14                         | 28                             |
| KMP 6     | ANCHOR Ø4x50              | 20                         | 40                             |
| KMP 7     | ANCHOR Ø4x50              | 12                         | 24                             |
| KMP 8     | ANCHOR Ø4x50              | 16                         | 32                             |
| KMP 9     | ANCHOR Ø4x50              | 28                         | 56                             |
| KMR 1     | ANCHOR Ø4x50              | 10                         | 20                             |
| KMR 2     | ANCHOR Ø4x50              | 10                         | 20                             |
| KMR 3     | ANCHOR Ø4x50              | 18                         | 36                             |
| KMR 4     | ANCHOR Ø4x50              | 18                         | 36                             |
| KMR 5     | ANCHOR Ø4x50              | 29                         | 58                             |
| KMR 6     | ANCHOR Ø4x50              | 29                         | 58                             |
| KMR 7     | ANCHOR Ø4x50              | 5                          | 10                             |
| KMR 8     | ANCHOR Ø4x50              | 11                         | 22                             |
| KMR 9     | ANCHOR Ø4x50              | 17                         | 34                             |
| KMRP 1    | ANCHOR Ø4x50              | 5                          | 10                             |
| KMRP 2    | ANCHOR Ø4x50              | 11                         | 22                             |
| KMRP 3    | ANCHOR Ø4x50              | 17                         | 34                             |
| LZ 0      | ANCHOR Ø4x50              | 7                          | 7                              |
| LZ 1      | ANCHOR Ø4x50              | 10                         | 20                             |
| LZ 2      | ANCHOR Ø4x50              | 10                         | 20                             |
| LZ 3      | ANCHOR Ø4x50              | 10                         | 20                             |
| KS 1      | ANCHOR Ø4x50              | 4                          | 8                              |
| KSO 1     | ANCHOR Ø4x50              | 4                          | 8                              |
| KS 2      | ANCHOR Ø4x50              | 4                          | 8                              |
| KSO 2     | ANCHOR Ø4x50              | 4                          | 8                              |
| KS 3      | ANCHOR Ø4x50              | 8                          | 16                             |
| KSO 3     | ANCHOR Ø4x50              | 8                          | 16                             |
| KWO 1     | ANCHOR Ø4x50              | 4                          | 8                              |
| KWO 2     | ANCHOR Ø4x50              | 4                          | 8                              |
| KWO 3     | ANCHOR Ø4x50              | 4                          | 8                              |
| KWO 4     | ANCHOR Ø4x50              | 4                          | 8                              |

| Connector | Dowel type fastener | Fasteners per Detail [pc.] | Fasteners per Connection [pc.] |
|-----------|---------------------|----------------------------|--------------------------------|
| KB 1      | ANCHOR Ø4x50        | 5                          | 10                             |
| KB 2      | ANCHOR Ø4x50        | 7                          | 14                             |
| KB 3      | ANCHOR Ø4x50        | 7                          | 14                             |
| KP 1      | ANCHOR Ø4x50        | 16                         | 32                             |
| KPL 1     | ANCHOR Ø4x50        | 16                         | 32                             |
| KP 2      | ANCHOR Ø4x50        | 20                         | 40                             |
| KPL 2     | ANCHOR Ø4x50        | 20                         | 40                             |
| KP 3      | ANCHOR Ø4x50        | 14                         | 28                             |
| KPL 3     | ANCHOR Ø4x50        | 14                         | 28                             |
| KP 4      | ANCHOR Ø4x50        | 16                         | 32                             |
| KPL 4     | ANCHOR Ø4x50        | 16                         | 32                             |
| KP 5      | ANCHOR Ø4x50        | 18                         | 36                             |
| KP 6      | ANCHOR Ø4x50        | 25                         | 50                             |
| KP 10     | Anchor Ø4x50        | 30                         | 60                             |
| KPL10     | Anchor Ø4x50        | 30                         | 60                             |
| KP 11     | ANCHOR Ø4x50        | 13                         | 26                             |
| KP 12     | Anchor Ø4x50        | 16                         | 32                             |
| KPL 12    | Anchor Ø4x50        | 16                         | 32                             |
| KP 13     | Anchor Ø4x50        | 18                         | 36                             |
| KP 14     | Anchor Ø4x50        | 21                         | 42                             |
| KP 15     | Anchor Ø4x50        | 8                          | 16                             |
| KP 21     | ANCHOR Ø4x50        | 18                         | 36                             |
| KL 1      | ANCHOR Ø4x50        | 8                          | 16                             |
| KL 2      | ANCHOR Ø4x50        | 16                         | 32                             |
| KL 3      | ANCHOR Ø4x50        | 16                         | 32                             |
| KL 4      | ANCHOR Ø4x50        | 16                         | 32                             |
| KL 5      | ANCHOR Ø4x50        | 20                         | 40                             |
| KL 101    | Anchor Ø4x50        | 8                          | 16                             |
| KL 104    | Anchor Ø4x50        | 16                         | 32                             |
| KL 105    | Anchor Ø4x50        | 20                         | 40                             |
| KW 1      | ANCHOR Ø4x50        | 4                          | 8                              |
| KW 2      | ANCHOR Ø4x50        | 4                          | 8                              |
| KW 3      | ANCHOR Ø4x50        | 4                          | 8                              |
| KW 4      | ANCHOR Ø4x50        | 4                          | 8                              |
| KW 5      | ANCHOR Ø4x50        | 4                          | 8                              |
| KW 6      | ANCHOR Ø4x50        | 4                          | 8                              |
| KW 7      | ANCHOR Ø4x50        | 4                          | 8                              |
| KW 25     | ANCHOR Ø4x50        | 4                          | 8                              |
| KW 30     | ANCHOR Ø4x50        | 4                          | 8                              |
| KW 40     | ANCHOR Ø4x50        | 4                          | 8                              |
| KW 50     | ANCHOR Ø4x50        | 4                          | 8                              |

| Connector      | Dowel type fastener                                   | Fasteners per Detail [pc.] | Fasteners per Connection [pc.] |
|----------------|---|----------------------------|--------------------------------|
| KW 60          | ANCHOR Ø4x50  | 4                          | 8                              |
| KW 80          | ANCHOR Ø4x50  | 6                          | 12                             |
| KW 100         | ANCHOR Ø4x50  | 6                          | 12                             |
| KW 125         | ANCHOR Ø4x50  | 6                          | 12                             |
| KW 150         | ANCHOR Ø4x50  | 6                          | 12                             |
| KK 1           | ANCHOR Ø4x50  | 14                         | 28                             |
| KK 2           | ANCHOR Ø4x50  | 20                         | 40                             |
| KK 3           | ANCHOR Ø4x50  | 26                         | 52                             |
| KK 21          | ANCHOR Ø4x50/ISO 4014 M 12x35 - 8.8 (washer ISO 7094) | 14\1                       | 28\2                           |
| KK 22          | ANCHOR Ø4x50/ISO 4014 M 12x35 - 8.8 (washer ISO 7094) | 24\1                       | 48\2                           |
| KK 23          | ANCHOR Ø4x50/ISO 4014 M 12x35 - 8.8 (washer ISO 7094) | 30\1                       | 60\2                           |
| KM 0           | Anchor Ø4x50  | 4                          | 8                              |
| KM 1           | ANCHOR Ø4x50  | 8                          | 16                             |
| KM 2           | ANCHOR Ø4x50  | 8                          | 16                             |
| KM 3           | ANCHOR Ø4x50  | 8                          | 16                             |
| KM 4           | ANCHOR Ø4x50  | 14                         | 28                             |
| KM 5           | ANCHOR Ø4x50  | 20                         | 40                             |
| KM 6           | ANCHOR Ø4x50  | 26                         | 52                             |
| KM 7           | ANCHOR Ø4x50  | 12                         | 24                             |
| KM 8           | ANCHOR Ø4x50  | 16                         | 32                             |
| KM 9           | ANCHOR Ø4x50  | 28                         | 56                             |
| KM 10          | ANCHOR Ø4x50  | 32                         | 64                             |
| KM 11          | ANCHOR Ø4x50  | 20                         | 40                             |
| KM 12          | ANCHOR Ø4x50  | 36                         | 72                             |
| KM 13          | ANCHOR Ø4x50  | 42                         | 84                             |
| KM 14          | ANCHOR Ø4x50  | 12                         | 24                             |
| KM 15          | ANCHOR Ø4x50  | 24                         | 48                             |
| KM 19          | ANCHOR Ø4x50  | 14                         | 28                             |
| KM 20          | ANCHOR Ø4x50  | 6                          | 12                             |
| KM 21          | Anchor Ø4x50  | 16                         | 32                             |
| KM 1 (2.5 mm)  | ANCHOR Ø4x50  | 8                          | 16                             |
| KM 2 (2.5 mm)  | ANCHOR Ø4x50  | 8                          | 16                             |
| KM 4 (2.5 mm)  | ANCHOR Ø4x50  | 14                         | 28                             |
| KM 5 (2.5 mm)  | ANCHOR Ø4x50  | 20                         | 40                             |
| KM 6 (2.5 mm)  | ANCHOR Ø4x50  | 26                         | 52                             |
| KM 7 (2.5 mm)  | ANCHOR Ø4x50  | 12                         | 24                             |
| KM 9 (2.5 mm)  | ANCHOR Ø4x50  | 28                         | 56                             |
| KM 10 (2.5 mm) | ANCHOR Ø4x50  | 32                         | 64                             |
| KM 11 (2.5 mm) | ANCHOR Ø4x50  | 20                         | 40                             |
| KM 12 (2.5 mm) | ANCHOR Ø4x50  | 36                         | 72                             |

| Connector      | Dowel type fastener                                      | Fasteners per Detail [pc.] | Fasteners per Connection [pc.] |
|----------------|--|----------------------------|--------------------------------|
| KM 13 (2.5 mm) | ANCHOR Ø4x50   | 42                         | 84                             |
| KM 14 (2.5 mm) | ANCHOR Ø4x50   | 12                         | 24                             |
| KM 15 (2.5 mm) | ANCHOR Ø4x50   | 24                         | 48                             |
| KM 16 (2.5 mm) | ANCHOR Ø4x50   | 12                         | 24                             |
| KM 17 (2.5 mm) | ANCHOR Ø4x50   | 8                          | 16                             |
| KM 18 (2.5 mm) | ANCHOR Ø4x50   | 12                         | 24                             |
| KM 19 (2.5 mm) | ANCHOR Ø4x50   | 14                         | 28                             |
| KM 20 (2.5 mm) | ANCHOR Ø4x50   | 6                          | 12                             |
| KM 22 (2.5 mm) | Anchor Ø4x50   | 20                         | 40                             |
| LBS 90         | Anchor Ø4x50   | 18                         | 36                             |
| LBS 105        | Anchor Ø4x50   | 24                         | 48                             |
| LBZ 95         | ANCHOR Ø4x50/ISO 4014 M 12x35 - 8.8<br>(washer ISO 7094) | 5\1                        | 10\2                           |
| LBZ 135        | ANCHOR Ø4x50/ISO 4014 M 12x35 - 8.8<br>(washer ISO 7094) | 8\1                        | 16\2                           |
| LBZ 285        | ANCHOR Ø4x50/ISO 4014 M 12x35 - 8.8<br>(washer ISO 7094) | 14\1                       | 28\1                           |

|   |                               |
|---|-------------------------------|
| <b>THREE-DIMENSIONAL NAILING PLATES</b> | <b>ANNEX 6</b><br>ETA 22/0631 |
| <b>REFERENCE DOCUMENTS</b>              |                               |

- [1] European Assessment Document 130186-00-0603, edition July 2018,  
Three-dimensional nailing plates
- [2] EN 10346 Continuously hot-dip coated steel flat products - Technical delivery conditions
- [3] EN 10131 Cold rolled uncoated and zinc or zinc-nickel electrolytically coated low carbon and high yield strength steel flat products for cold forming - Tolerances on dimensions and shape
- [4] EN 10025-2 Hot rolled products of structural steels - Part 2: Technical delivery conditions for non-alloy structural steels
- [5] EN 14592+A1 Timber structures - Dowel-type fasteners – Requirements
- [6] EN 1995-1-1 Eurocode 5: Design of timber structures - Part 1-1: General - Common rules and rules for buildings
- [7] EN ISO 12944-2 Paints and varnishes - Corrosion protection of steel structures by protective paint systems - Part 2: Classification of environments
- [8] EN ISO 8970 Timber structures - Testing of joints made with mechanical fasteners - Requirements for wood density
- [9] EN 26891 Timber structures – Joints made with mechanical fasteners – General principles for the determination of strength and deformation characteristics
- [10] EN 384+A2 Structural timber – Determination of characteristic values of mechanical properties and density
- [11] EN 13183-2 Moisture content of a piece of sawn timber - Part 2: Estimation by electrical resistance method
- [12] EN 1309-1 Round and sawn timber - Method of measurement of dimensions - Part 1: Sawn timber
- [13] EN 14358 Timber structures – Calculation and verification of characteristic values
- [14] EN 13501-1 Fire classification of construction products and building elements - Part 1: Classification using test data from reaction to fire tests
- [15] EN 10130 Cold rolled low carbon steel flat products for cold forming - Technical delivery conditions